

made in italy



ALBERTONI

La tecnologia che semplifica
dal 1961



Catalogo Listino 2026

Price list 2026

made in italy



ALBERTONI

*La tecnologia che semplifica
dal 1961*



Azienda Company

VA Albertoni dal 1961 in uno dei distretti storici della manifattura italiana, produce rubinetti sottolavabo e componenti tecnici per impianti igienicosanitari.

Negli oltre 60 di storia l'azienda ha sviluppato l'abilità di personalizzare la propria produzione al servizio delle esigenze degli installatori dei diversi mercati e dei diversi segmenti di vendita, dal cliente OEM, fino ad arrivare alla filiera di distribuzione idrotermosanitaria, con una vasta offerta di prodotti a marchio VA Albertoni. Siamo presenti sul mercato nazionale con una rete agenti capillare ed esperta ed esportiamo in oltre 60 paesi esteri attraverso clienti diretti ed esportatori esclusivi.

L'innovazione, la ricerca e l'utilizzo delle tecnologie più avanzate, insieme all'impegno costante verso una produzione attenta alla conformità delle normative vigenti, hanno contribuito a far diventare VA Albertoni un riferimento tra i più qualificati sui mercati internazionali del settore.

L'azienda fa parte della associazione di categoria AVR, federata ad Anima Confindustria, con un ruolo attivo nell'associazione che rappresenta le aziende italiane del settore valvole e rubinetteria.

VA Albertoni sostiene la "filiera Made in Italy", infatti tutti i nostri articoli sono prodotti nello stabilimento di Gozzano in provincia di Novara e anche le lavorazioni non interne sono fornite totalmente da una filiera italiana.

VA Albertoni is since 1961 in one of the historic districts of the Italian manufacture, the company produces angle valves and technical components for plumbing systems. In over 60 years, the company has developed the ability to customize its production to meet the needs of installers of different markets and sales segments, from OEM customers to the supply chain of sanitary installation with a wide range of products branded VA Albertoni. We are in the domestic market with a complete and expert agent network and export to over 60 countries through direct customers and exclusive exporters.

Innovation, research and use of the most advanced technologies, together with the commitment to a production in compliance with current regulations, have contributed to lead VA Albertoni to be one of the most qualified in the international markets of the sector.

The company is part of the AVR association, federated with Anima Confindustria, with an active role in representing Italian companies in the valve and faucet sector.

VA Albertoni supports "Made in Italy" supply chain, in fact all our products are made in Gozzano in the area of Novara and the outsourced processes are supplied by Italian's company.





VA Albertoni, la storia e il territorio con il Lago d'Orta

VA Albertoni, history and territory with Lake Orta

VA Albertoni viene fondata nel 1955 da Secondo Albertoni e dal figlio Vittorio ad Alzo di Pella.

Trasferita a Gozzano nel 1961 ha sempre mantenuto un forte legame con il territorio di "Cusio", l'antico nome del Lago d'Orta.

Legata al Cusio, ha sempre riconosciuto come fondamentale l'impronta del territorio nella sua cultura aziendale in un proficuo scambio di energie e di risorse intellettuali ed economiche.

Da questa idea nasce il sostegno alle iniziative di Ecomuseo Cusius. Una realtà museale che ha il proprio fine nel ricostruire, testimoniare e promuovere la memoria storica della vita, delle tradizioni, della cultura materiale e sociale e del modo in cui l'insediamento tradizionale ha caratterizzato la formazione e l'evoluzione del paesaggio attorno al Lago d'Orta.

Nel 2019 si sono celebrati gli 800 anni dell'istituzione della Riviera di San Giulio e del Lago d'Orta (1219). Con questo ordinamento le popolazioni locali fecero fronte comune per proteggere il proprio territorio. Esempio che oggi possiamo seguire con lo strumento del Contratto di Lago promosso da Ecomuseo Cusius, in cui VA Albertoni, insieme ad altre associazioni pubbliche e private, si impegna a collaborare a politiche atte a salvaguardare il territorio, il suo ambiente e il suo ecosistema.

Inoltre dal 1997 VA Albertoni promuove il territorio attraverso il suo oramai consueto "Calendario del Cusio", quest'anno al suo 26esimo anno dalla prima pubblicazione. Ogni anno attraverso questa iniziativa, vengono promosse immagini e scorci della terra e del territorio del Cusio, la sua geografia, la sua storia e le sue tradizioni, con focus annuali tematici.

VA Albertoni was founded in 1955 by Secondo Albertoni and his son Vittorio in Alzo di Pella. It moved to Gozzano in 1961 and it has always maintained a strong link with the territory of "Cusio", the ancient name of the territory of Lake Orta.

The footprint of the territory has always been recognized as important in its corporate culture, in an exchange of energies and intellectual and economic resources.

From this comes the support to the initiatives of Ecomuseo Cusius. A reality that has its purpose in reconstructing, witnessing and promoting the historical memory of life, traditions, social culture and the way how the past settlements has characterized the formation and evolution of the landscape around Lake Orta.

In 2019 has been celebrated the 800 years from the establishment of the Riviera of San Giulio and Lake Orta (1219). With this arrangement the local populations made a common front to protect their territory. Example that today we can follow with the instrument of the Lake Contract promoted by Ecomuseo Cusius, in which VA Albertoni, together with other public and private associations, is committed to collaborating on policies to safeguard the territory, its environment and its ecosystem.

In addition, since 1997 VA Albertoni promotes the territory through its now traditional "Calendar of Cusio", this year with its 26th edition since its first publication. Every year images and glimpses of the land and territory of Cusio are shown, its geography, its history and its traditions are promoted, with annual thematic focus.





Produzione *Production*

Fiore all'occhiello di VA Albertoni è la produzione!

Nel corso dei 60 anni di storia, continui e costanti investimenti in tecnologie hanno portato VA Albertoni ad essere una delle aziende europee maggiormente evolute in termini di capacità produttiva.

Nella sede di Gozzano in provincia di Novara, gli impianti di produzione includono la produzione dei tubi in rame, la meccanica, la torneria, la burattatura e l'assemblaggio, il tutto coordinato dal reparto di produzione che lavora a stretto contatto con un team di esperti in progettazione, ricerca e analisi di laboratorio, al fine di monitorare le diverse fasi produttive e controllare gli elevati standard qualitativi.

Questo costante impegno porta oggi l'azienda a produrre oltre 40.000 rubinetti al giorno, contando poi di fatto più di 9.000.000 di pezzi in un anno.

VA Albertoni's flagship is production!

Over the course of 60 years of history, continuous and constant investments in technologies have led VA Albertoni to be one of the most advanced European companies in terms of production capacity.

At the Gozzano site in the province of Novara, the production facilities include the production of copper pipes, mechanics, turning, tumbling and assembly, all coordinated by the production department that works closely with a team of experts in design, research and laboratory analysis, in order to monitor the different stages of production and check the high quality standards.

This constant commitment today leads the company to produce over 40,000 taps per day, counting then in fact more than 9,000,000 pieces in a year.

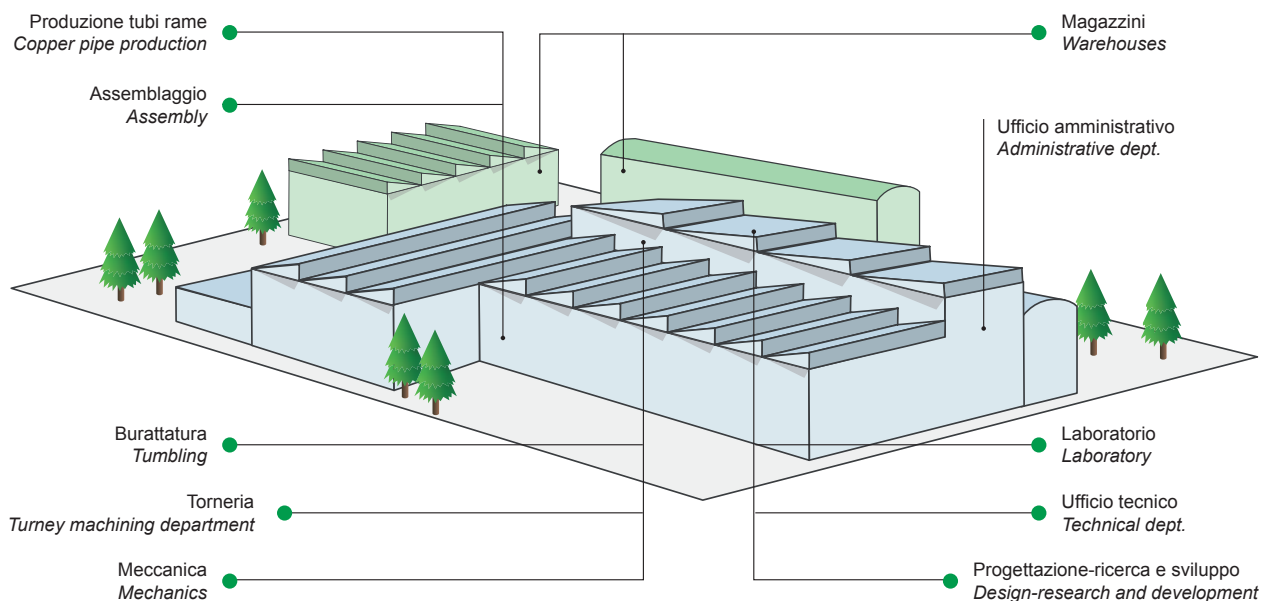

100%
Made in Italy



500

Clienti Italia
diretti, gruppi, fai da te

Italian customers
direct, groups,
do-it-yourself



60

Export paesi al mondo
clienti diretti,
importatori esclusivi

Export to countries
worldwide direct
customers, exclusive
importers, factories



50

Dipendenti
Employees



40.000

Rubinetti prodotti al giorno

Valves produced per day



9.000.000

Pezzi anno

Pieces per year



Qualità e Certificazioni *Quality and Certifications*









L'elevato standard qualitativo e l'impegno costante della produzione VA Albertoni, hanno permesso di ottenere numerose certificazioni internazionali che rispondono alle conformità delle normative vigenti.

Il processo produttivo è certificato secondo ISO9001 e i prodotti vengono sottoposti a prove di tenuta idraulica. Un attento controllo in tutte le fasi produttive garantisce insieme ai singoli cicli di lavorazione, di stampaggio e confezionamento, un risultato di alta qualità. Tutto questo permette alla VA Albertoni di competere sui mercati internazionali, proponendo prodotti in circa 60 Paesi al mondo e di avere partnership con importanti player internazionali.

The high quality standard and the constant commitment of Albertoni VA production, have achieved numerous international certifications that comply with current regulations. The production process is certified according to ISO9001 and the products are subjected to hydraulic tightness tests.

A careful control in all the production phases guarantees a high quality result. All this allows VA Albertoni to compete in international markets, offering products in about 60 countries worldwide and to have partnerships with important international players.

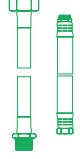

	Serie "Linea" / "LINEA"	9
	Rubinetti filtro / Filtered angle valves	21
	Curvette / Elbows	31
	Rubinetti lavatrice / Angle valves for washing machine	39
	Rubinetti giardino / Garden taps	61
	Rubinetti sottolavabo / Angle valves	67
	Rubinetti multiuso / Multipurpose angle valves	77
	Rubinetti per cassetta / Angle valves for WC cistern	81
	Rubinetti per scaldabagno / Angle valves for water heater	88
	Valvole minisfera / Mini ball valves	90
	Raccordi / Fittings	93
	Dadi / Nuts	110
	Guarnizioni / Washers	111
	Tubi rame / Copper pipes	115
	Tubi ottone / Brass pipes	121
	Rosoni / Cover plates	126
	Flessibili inox / Stainless steel flex hoses	133
	Flessibili antivibranti Inox / Vibration dumping inox hoses	139
	Sifoni / Siphons	142
	Scarichi / Wastes	146
VARIE	Aeratori / Aerators	152
VARIOUS	Flessibili doccia / Shower hoses	155
	Accessori per docce / Shower accessories	157
	Colorati / Colors	161
	Indice per articolo / Article index	169
	Condizioni generali di vendita / General sale terms	186

made in Italy



La tecnologia che semplifica
dal 1961

La serie “Linea” è offerta per installazioni dove il design è importante. Rubinetti sottolavabo lucidati con maniglie di design. Disponibili anche nelle versioni colorate, indicati per applicazioni a vista.

The “Linea” series is offered for installations where design is important. Polished angle valve with designed handles. Also available in colored versions, suitable for exposed applications.

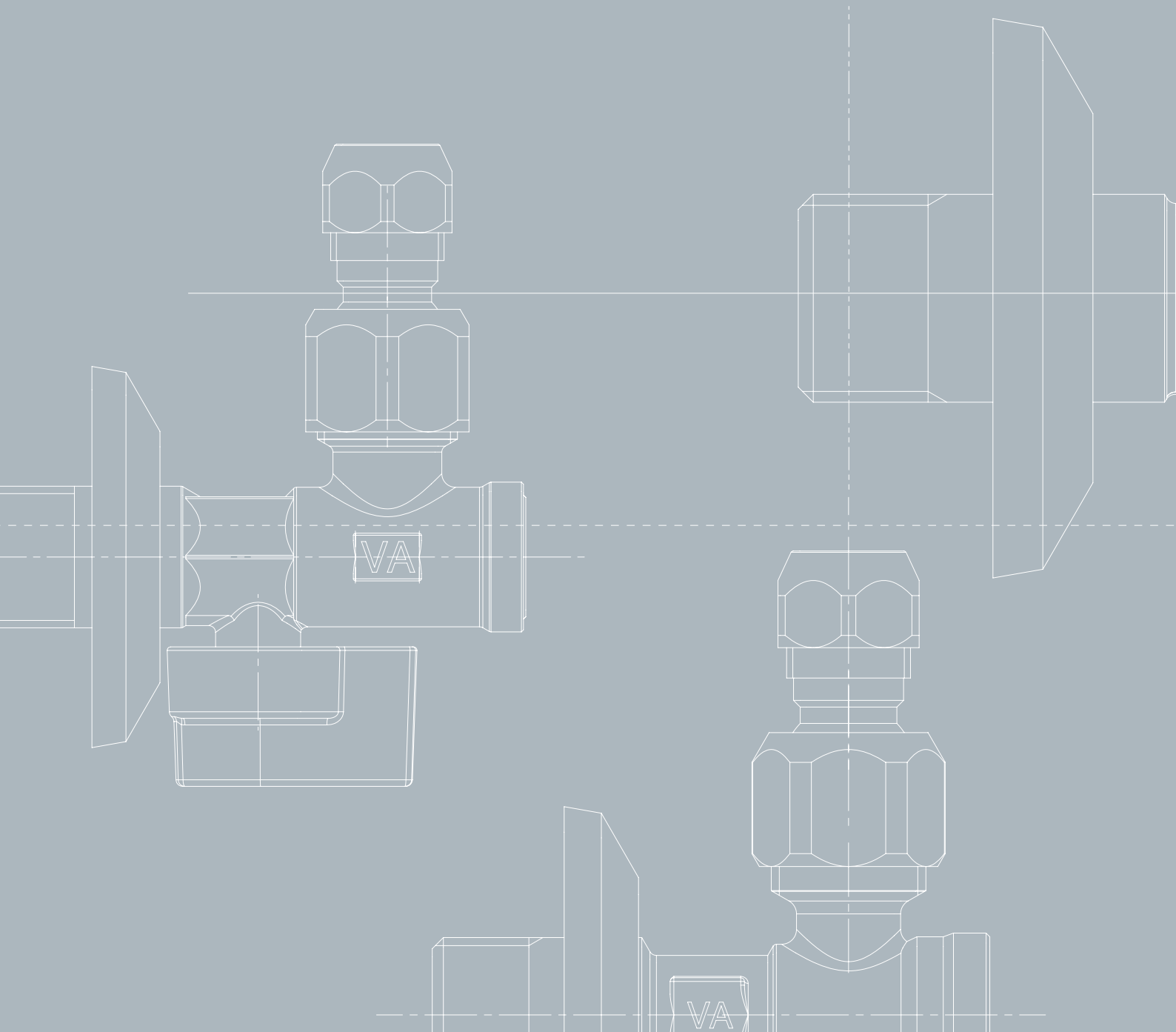



Serie “Linea”

“LINEA”

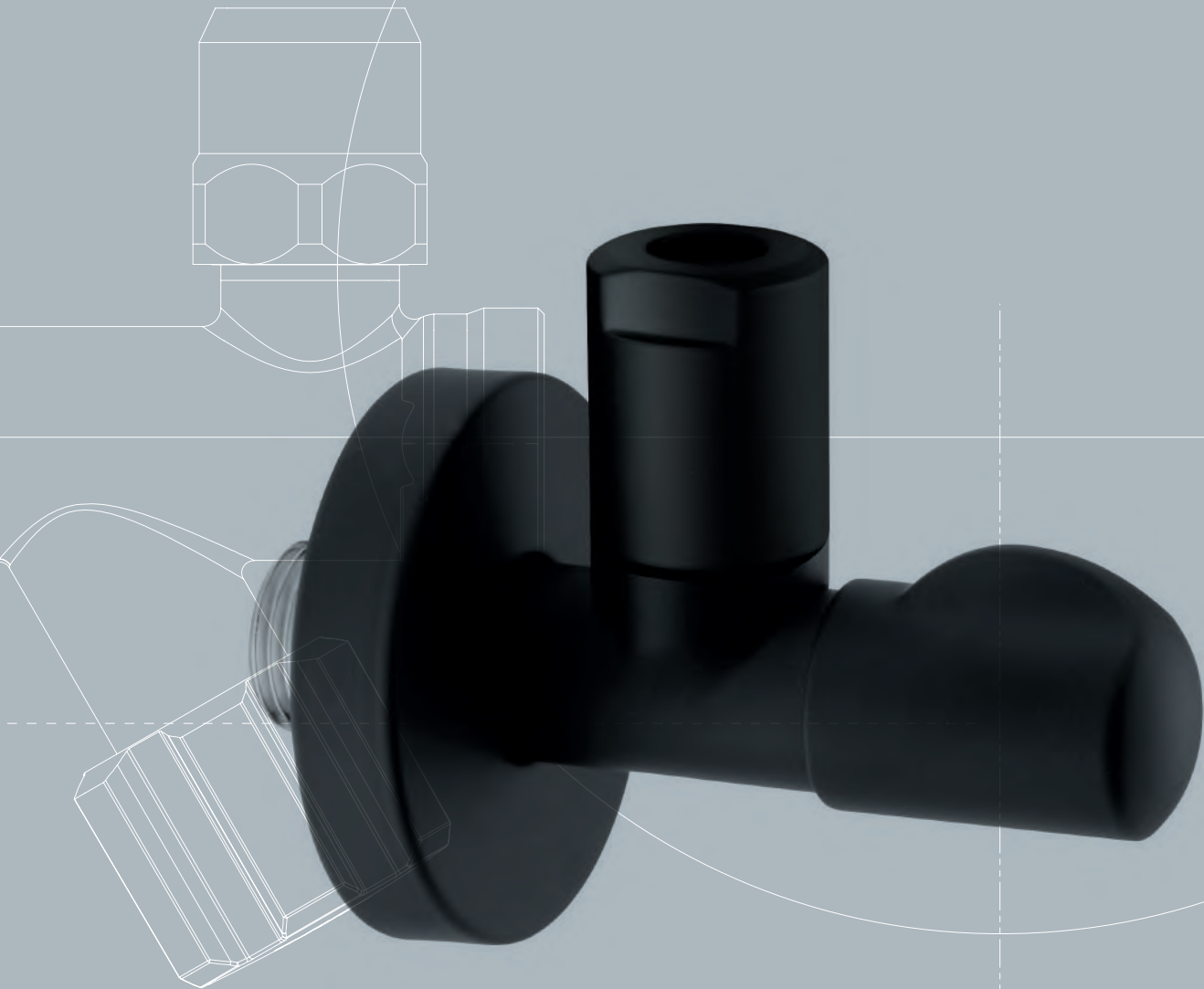

Serie "Linea" / "LINEA"

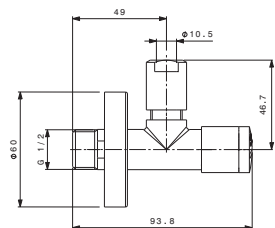

Rubinetto sottolavabo LINEA con filtro, vitone, maniglia ottone, rosone ottone, dado cilindrico, cromato. Vitone brevettato n°22566 B/85
Box 50 pz.

Filter angle valve LINEA, multium, brass handle, brass cover plate, cylindrical compression nut, chrome plated. Patent licence n°22566 B/85
Box 50 pz.

Cod.	Dim.	Kg/Pz.	Conf.	Pkg	Fin.	€
L143481	M1/2" x M3/8" x Ø10	0,28	1		cr / chr	31,78

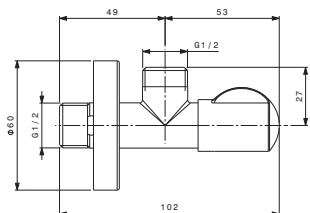

Rubinetto sottolavabo LINEA, vitone, maniglia zama GOCCIA, rosone ottone, cromato
Box 50 pz.

Angle valve LINEA, multium, zamak handle GOCCIA, brass cover plate, chrome plated
Box 50 pz.

Cod.	Dim.	Kg/Pz.	Conf.	Pkg	Fin.	€
L446450	M1/2" x M3/8"	0,23	1		cr / chr	20,35
L448650	M1/2" x M1/2"	0,23	1		cr / chr	21,23

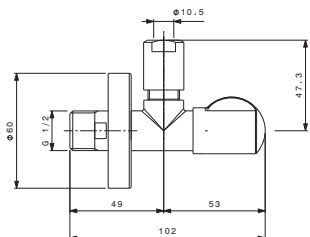

Rubinetto sottolavabo LINEA, vitone, maniglia zama GOCCIA, rosone ottone, dado cilindrico, cromato
Box 50 pz.

Angle valve LINEA, multium, zamak handle GOCCIA, brass cover plate, cylindrical compression nut, chrome plated
Box 50 pz.

Cod.	Dim.	Kg/Pz.	Conf.	Pkg	Fin.	€
L447650	M1/2" x M3/8" x Ø10	0,27	1		cr / chr	24,19

Serie "Linea" / "LINEA"

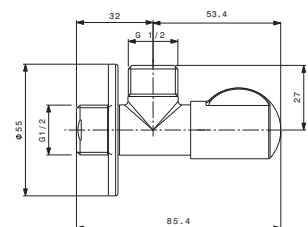

Rubinetto sottolavabo, vitone quarto di giro, maniglia zama GOCCIA, rosone ottone, cromato
Box 50 pz.

Angle valve LINEA, quarter turn spindle, zamak handle GOCCIA, brass cover plate, chrome plated
Box 50 pz.

Cod.	Dim.	Kg/Pz.	Conf.	Pkg	Fin.	€
L105650	M1/2" x M1/2"	0,20	1		cr / chr	17,83

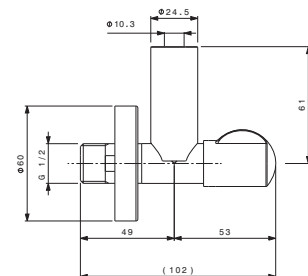

Rubinetto sottolavabo LINEA, vitone, maniglia zama, con rosone ottone, con carter, cromato
Box 50 pz.

Angle valve LINEA, multiturn, zamak handle, brass cover plate, with carter, chrome plated
Box 50 pz.

Cod.	Dim.	Kg/Pz.	Conf.	Pkg	Fin.	€
L441650	M1/2" x M3/8"	0,29	1		cr / chr	31,24

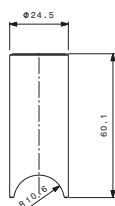

Carter cromato con guarnizione
Box 50 pz.

Chromed crankcase with gasket
Box 50 pz.

Cod.	Dim.	Kg/Pz.	Conf.	Pkg	Fin.	€
L202560		0,04	1		cr / chr	11,89

Serie "Linea" / "LINEA"



Rubinetto sottolavabo
LINEA QUADRO,
vitone, maniglia ottone
QUADRO, rosone
ottone, cromato
Box 50 pz.

Angle valve LINEA
QUADRO, multium,
brass handle QUADRO,
brass cover plate,
chrome plated
Box 50 pz.

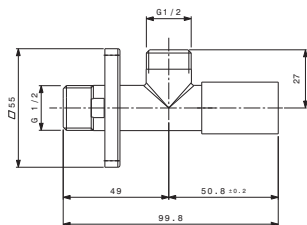

Cod.	Dim.	Kg/Pz.	Conf.	Pkg	Fin.	€
L448604	M1/2" x M1/2"	0,28	1		cr / chr	28,35



Rubinetto sottolavabo
LINEA QUADRO,
vitone, maniglia ottone
QUADRO, rosone
ottone, dado cilindrico,
cromato
Box 50 pz.

Angle valve LINEA
QUADRO, multium,
brass handle QUADRO,
brass cover plate,
cylindrical compression
nut, chrome plated
Box 50 pz.

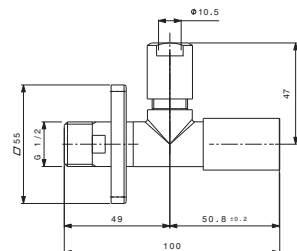

Cod.	Dim.	Kg/Pz.	Conf.	Pkg	Fin.	€
L447604	M1/2" x M3/8" x Ø10	0,32	1		cr / chr	31,15



Rubinetto sottolavabo
QUADRO, vitone,
maniglia ottone
QUADRO, rosone
ottone, dado cilindrico,
cromato
Box 50 pz.

Angle valve QUADRO,
multium, brass handle
QUADRO, brass
cover plate, cylindrical
compression nut,
chrome plated
Box 50 pz.

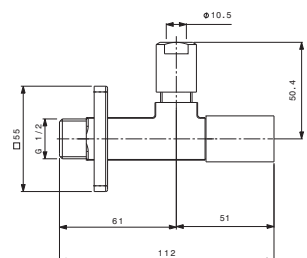

Cod.	Dim.	Kg/Pz.	Conf.	Pkg	Fin.	€
L447681Q	M1/2" x M3/8" x Ø10	0,41	1		cr / chr	47,54

Serie "Linea" / "LINEA"



Rubinetto sottolavabo
LINEA, vitone
multigiro, maniglia
zama GOCCIA, rosone
ottone
Box 20 pz.

Angle valve LINEA,
multiturn spindle, zamak
handle GOCCIA, brass
cover plate.
Box 20 pz.

Cod.	Dim.	Kg/Pz.	Conf.	Pkg	Fin.	€
AMB446450	M1/2" x M3/8"	0,23	1		Nero opaco / Matt black	39,99
AMB448650L	M1/2" x M1/2"	0,23	1		Nero opaco / Matt black	40,71

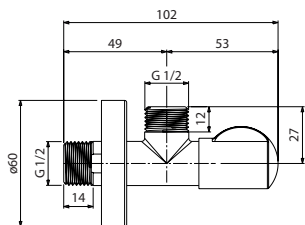

Rubinetto sottolavabo
LINEA, vitone, maniglia
zama GOCCIA, rosone
ottone, dado cilindrico.
Box 20 pz.

Angle valve LINEA,
multiturn spindle, zamak
handle GOCCIA, brass
cover plate, cylindrical
nut.
Box 20 pz.

Cod.	Dim.	Kg/Pz.	Conf.	Pkg	Fin.	€
AMB447650	M1/2" x M3/8" x Ø10	0,26	1		Nero opaco / Matt black	44,43

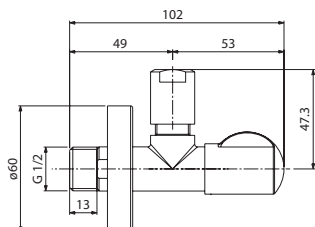

Rubinetto sottolavabo
LINEA, vitone,
maniglia zama, con
rosone ottone, con
carter
Box 50 pz.

Angle valve LINEA,
multiturn spindle, zamak
handle, brass cover
plate, with carter
Box 50 pz.

Cod.	Dim.	Kg/Pz.	Conf.	Pkg	Fin.	€
AMB441650	M1/2" x M3/8"	0,29	1		Nero opaco / Matt black	59,02

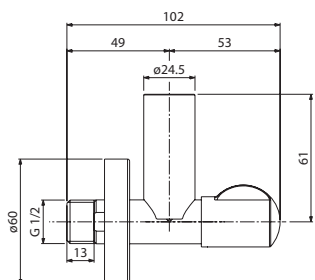

Serie "Linea" / "LINEA"



Rubinetto sottolavabo LINEA, vitone multigiuro, maniglia zama GOCCIA, rosone ottone
Box 20 pz.

Angle valve LINEA, multiturn spindle, zamak handle GOCCIA, brass cover plate.
Box 20 pz.

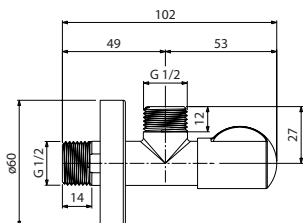

Cod.	Dim.	Kg/Pz.	Conf.	Pkg	Fin.	€
ANS446450	M1/2" x M3/8"	0,23	1		Nickel spazzolato / Brushed nickel	23,85
ANS448650L	M1/2" x M1/2"	0,23	1		Nickel spazzolato / Brushed nickel	39,23



Rubinetto sottolavabo LINEA, vitone, maniglia zama GOCCIA, rosone ottone, dado cilindrico
Box 20 pz.

Angle valve LINEA, multiturn spindle, zamak handle GOCCIA, brass cover plate, cylindrical nut.
Box 20 pz.

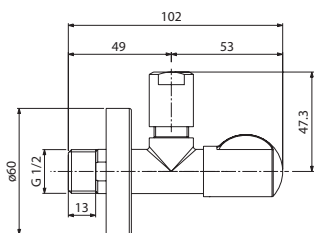

Cod.	Dim.	Kg/Pz.	Conf.	Pkg	Fin.	€
ANS447650	M1/2" x M3/8" x Ø10	0,26	1		Nickel spazzolato / Brushed nickel	44,43



Rubinetto sottolavabo LINEA, vitone, maniglia zama, con rosone ottone, con carter
Box 20 pz.

Angle valve LINEA, multiturn spindle, zamak handle, brass cover plate, with carter
Box 20 pz.

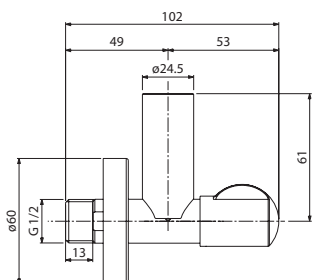

Cod.	Dim.	Kg/Pz.	Conf.	Pkg	Fin.	€
ANS441650	M1/2" x M3/8"	0,29	1		Nickel spazzolato / Brushed nickel	59,02

Serie "Linea" / "LINEA"



Rubinetto sottolavabo LINEA, vitone multigiro, maniglia zama GOCCIA, rosone ottone
Box 20 pz.

Cod.	Dim.	Kg/Pz.	Conf.	Pkg	Fin.	€
AFO446450	M1/2" x M3/8"	0,23	1		Flash oro / Flash gold	54,98
AFO448650L	M1/2" x M1/2"	0,23	1		Flash oro / Flash gold	54,98

Angle valve LINEA, multiturn spindle, zamak handle GOCCIA, brass cover plate.
Box 20 pz.

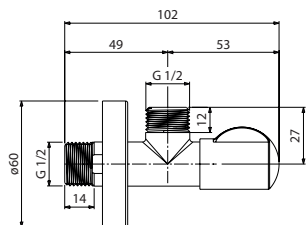

Rubinetto sottolavabo LINEA, vitone, maniglia zama GOCCIA, rosone ottone, dado cilindrico
Box 20 pz.

Cod.	Dim.	Kg/Pz.	Conf.	Pkg	Fin.	€
AFO447650	M1/2" x M3/8" x Ø10	0,26	1		Flash oro / Flash gold	44,43

Angle valve LINEA, multiturn spindle, zamak handle GOCCIA, brass cover plate, cylindrical nut.
Box 20 pz.

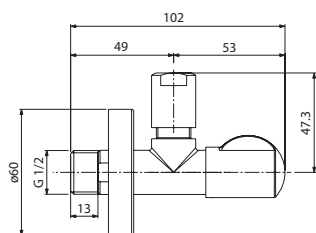

Rubinetto sottolavabo LINEA, vitone, maniglia zama, con rosone ottone, con carter
Box 20 pz.

Cod.	Dim.	Kg/Pz.	Conf.	Pkg	Fin.	€
AFO441650	M1/2" x M3/8"	0,29	1		Flash oro / Flash gold	59,02

Angle valve LINEA, multiturn spindle, zamak handle, brass cover plate, with carter
Box 20 pz.

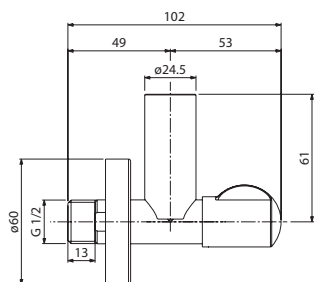

Serie "Linea" / "LINEA"



Rubinetto sottolavabo LINEA, vitone multigiuro, maniglia zama GOCCIA, rosone ottone
Box 20 pz.

Angle valve LINEA, multiturn spindle, zamak handle GOCCIA, brass cover plate.
Box 20 pz.

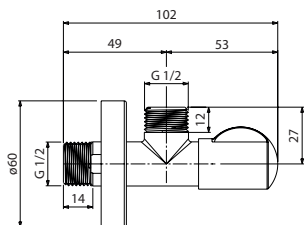

Cod.	Dim.	Kg/Pz.	Conf.	Pkg	Fin.	€
ARA446450	M1/2" x M3/8"	0,23	1		Ramato / Copper	23,85
ARA448650L	M1/2" x M1/2"	0,23	1		Ramato / Copper	42,57



Rubinetto sottolavabo LINEA, vitone, maniglia zama GOCCIA, rosone ottone, dado cilindrico
Box 20 pz.

Angle valve LINEA, multiturn spindle, zamak handle GOCCIA, brass cover plate, cylindrical nut.
Box 20 pz.

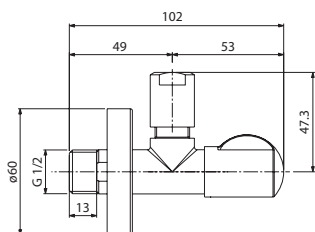

Cod.	Dim.	Kg/Pz.	Conf.	Pkg	Fin.	€
ARA447650	M1/2" x M3/8" x Ø10	0,26	1		Ramato / Copper	44,43



Rubinetto sottolavabo LINEA, vitone, maniglia zama, con rosone ottone, con carter
Box 20 pz.

Angle valve LINEA, multiturn spindle, zamak handle, brass cover plate, with carter
Box 20 pz.

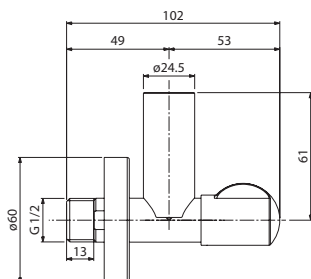

Cod.	Dim.	Kg/Pz.	Conf.	Pkg	Fin.	€
ARA441650	M1/2" x M3/8"	0,29	1		Ramato / Copper	59,02

Serie "Linea" / "LINEA"



Rubinetto sottolavabo
LINEA, vitone
multigiro, maniglia
zama GOCCIA, rosone
ottone
Box 20 pz.

Angle valve LINEA,
multiturn spindle, zamak
handle GOCCIA, brass
cover plate.
Box 20 pz.

Cod.	Dim.	Kg/Pz.	Conf.	Pkg	Fin.	€
ABZ446450	M1/2" x M3/8"	0,23	1		Bronzo / Bronze	23,85
ABZ448650L	M1/2" x M1/2"	0,23	1		Bronzo / Bronze	42,57

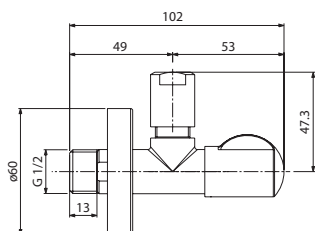

Rubinetto sottolavabo
LINEA, vitone, maniglia
zama GOCCIA, rosone
ottone, dado cilindrico
Box 20 pz.



Angle valve LINEA,
multiturn spindle, zamak
handle GOCCIA, brass
cover plate, cylindrical
nut.
Box 20 pz.

Cod.	Dim.	Kg/Pz.	Conf.	Pkg	Fin.	€
ABZ447650	M1/2" x M3/8" x Ø10	0,26	1		Bronzo / Bronze	44,43

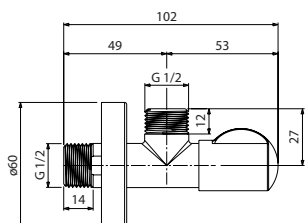

Rubinetto sottolavabo
LINEA, vitone,
maniglia zama, con
rosone ottone, con
carter
Box 20 pz.



Angle valve LINEA,
multiturn spindle, zamak
handle, brass cover
plate, with carter
Box 20 pz.

Cod.	Dim.	Kg/Pz.	Conf.	Pkg	Fin.	€
ABZ441650	M1/2" x M3/8"	0,29	1		Bronzo / Bronze	59,02

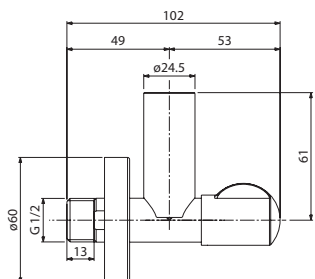

Serie "Linea" / "LINEA"



Rubinetto sottolavabo
LINEA Inox steel 316L,
vitone inox multigiro,
maniglia inox, rosone
inox
Box 10 pz.

Angle valve LINEA inox
steel 316L, multiturn
inox spindle, inox
handle, inox cover plate.
Box 10 pz.

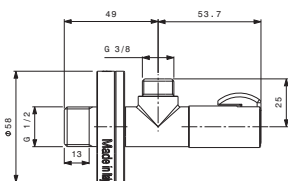

Cod.	Dim.	Kg/Pz.	Conf.	Pkg	Fin.	€
F446450	M1/2" x M3/8"	0,26	1		inox / steel	122,03



Rubinetto sottolavabo
LINEA Inox steel 316L,
vitone inox multigiro,
maniglia inox, rosone
inox, dado ottone
Box 10 pz.

Angle valve LINEA inox
steel 316L, multiturn
inox spindle, inox
handle, inox cover plate,
brass nut.
Box 10 pz.

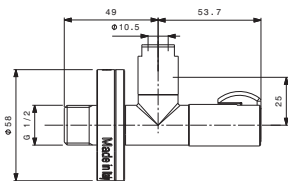

Cod.	Dim.	Kg/Pz.	Conf.	Pkg	Fin.	€
F447650	M1/2" x M3/8" x Ø10	0,30	1		inox / steel	129,15



Rubinetto sottolavabo
LINEA Inox steel 316L,
vitone inox multigiro,
maniglia inox, rosone
inox, con carter
Box 10 pz.

Angle valve LINEA inox
steel 316L, multiturn
inox spindle, inox
handle, inox cover plate,
with carter.
Box 10 pz.

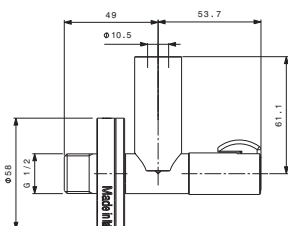

Cod.	Dim.	Kg/Pz.	Conf.	Pkg	Fin.	€
F441650	M1/2" x M3/8"	0,30	1		inox / steel	137,59



made in Italy



ALBERTONI

*La tecnologia che semplifica
dal 1961*

La serie di rubinetti con filtro viene prodotta come prima azienda italiana dal 1978. Viene proposta in un'ampia varietà di modelli, consentendo la scelta più adatta in funzione dell'esigenza di installazione.

I prodotti con filtro proteggono gli impianti dalle impurità.

The series of filtered angle valves has been produced as first Italian company since 1978. It is offered in a wide variety of models, allowing for the most suitable choice based on installation requirements. Filtered products protect systems from impurities.

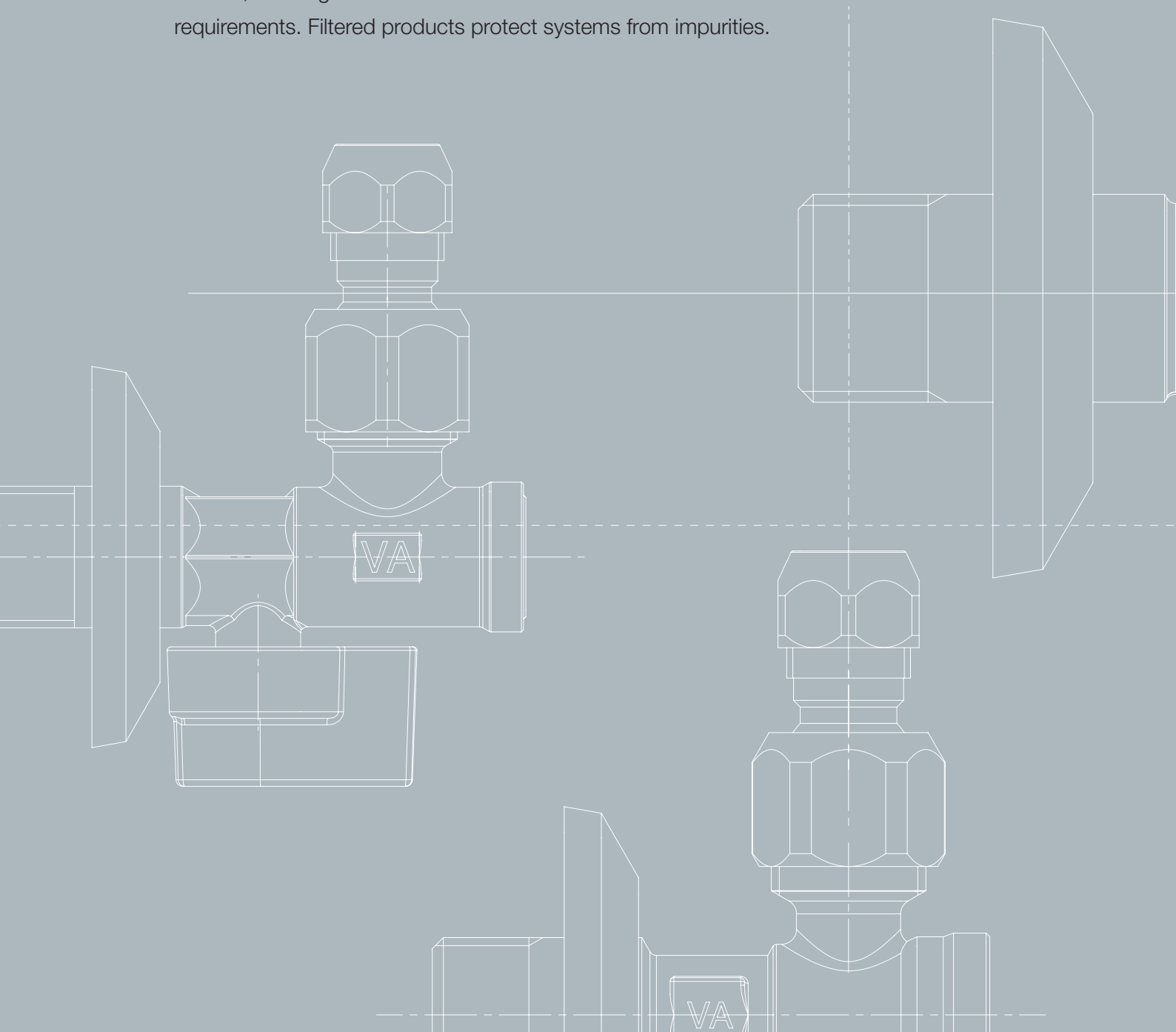



Rubinetti filtro

Filtered angle valves

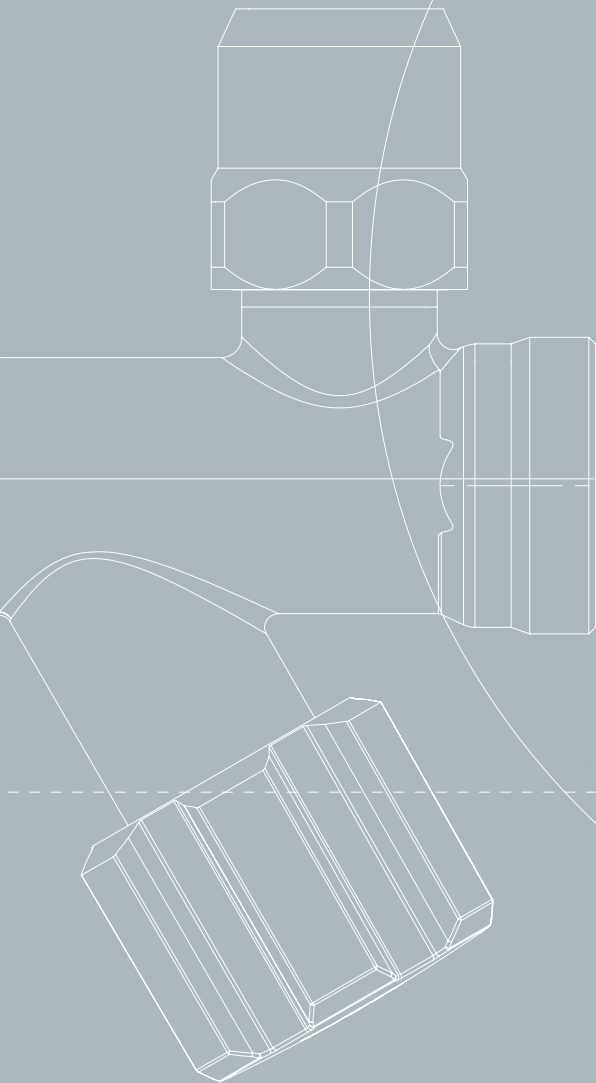

Rubinetti filtro / Filtered angle valves



Rubinetto sottolavabo con filtro, vitone, maniglia ABS, rosone inox, cromato
Box 100 pz.

Filtered angle valve, multitem, ABS handle, cover plate, chrome plated
Box 100 pz.

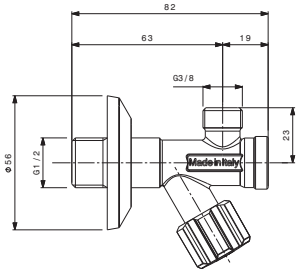

Cod.	Dim.	Kg/Pz.	Conf.	Pkg	Fin.	€
B142981	M1/2" x M3/8"	0,17	1		cr / chr	8,51
B141481	M1/2" x M1/2"	0,18	1		cr / chr	9,45



Rubinetto sottolavabo con filtro, vitone, maniglia ABS, rosone inox, dado conico alto, cromato
Box 50 pz.

Filtered angle valve, multitem, ABS handle, cover plate, compression nut, chrome plated
Box 50 pz.

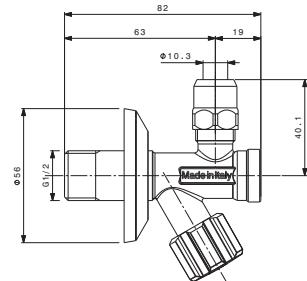

Cod.	Dim.	Kg/Pz.	Conf.	Pkg	Fin.	€
B147181	M3/8" x M3/8" x Ø10	0,20	1		cr / chr	11,34
B147281	M1/2" x M3/8" x Ø10	0,20	2		cr / chr	10,17
B147281SAC	M1/2" x M3/8" x Ø10	0,20	1		cr / chr	10,15



Rubinetto sottolavabo con filtro, vitone, maniglia ABS, rosone inox, dado conico alto, anello di tenuta PTFE, cromato
Box 50 pz.

Filtered angle valve, multitem, ABS handle, cover plate, compression nut, with PTFE ring, chrome plated
Box 50 pz.

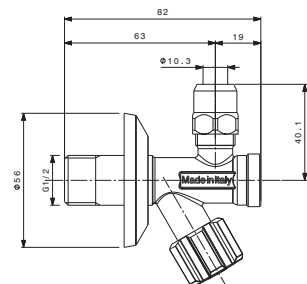

Cod.	Dim.	Kg/Pz.	Conf.	Pkg	Fin.	€
B142481	M1/2" x M3/8" x Ø10	0,20	1		cr / chr	13,09

Rubinetti filtro / Filtered angle valves



Rubinetto sottolavabo con filtro, vitone, maniglia ABS, rosone inox, snodo e dado conico alto, cromato Box 50 pz.

Filtered angle valve, multitem, ABS handle, cover plate, with ball joint and compression nut, chrome plated Box 50 pz.

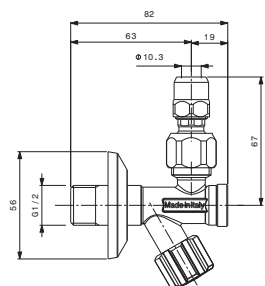

Cod.	Dim.	Kg/Pz.	Conf.	Pkg	Fin.	€
B140181	M3/8" x M3/8" x Ø10	0,28	1		cr / chr	17,64
B147381	M1/2" x M3/8" x Ø10	0,26	2		cr / chr	12,71
B147381SAC	M1/2" x M3/8" x Ø10	0,26	1		cr / chr	12,68



Rubinetto sottolavabo con filtro, vitone, maniglia ottone, rosone inox, snodo e dado conico alto, cromato Box 50 pz.

Filtered angle valve, multitem, brass handle, cover plate, with ball joint and compression nut, chrome plated Box 50 pz.

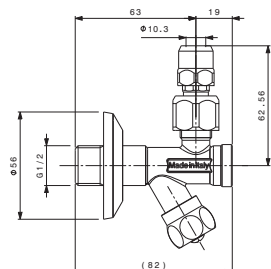

Cod.	Dim.	Kg/Pz.	Conf.	Pkg	Fin.	€
B147380	M1/2" x M3/8" x Ø10	0,28	2		cr / chr	17,02



Rubinetto sottolavabo con filtro, vitone, maniglia ottone BIRILLI, rosone inox, snodo e dado conico, cromato Box 50 pz.

Filtered angle valve, multitem, brass handle BIRILLI, cover plate, with ball joint and compression nut, chrome plated Box 50 pz.

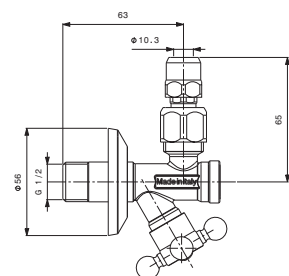

Cod.	Dim.	Kg/Pz.	Conf.	Pkg	Fin.	€
B147392	M1/2" x M3/8"	0,32	2		cr / chr	29,46

Rubinetti filtro / Filtered angle valves



Rubinetto sottolavabo con filtro, vitone, maniglia ABS bianca, rosone inox, cromato
Box 100 pz.

Filtered angle valve, multitem, ABS white handle, cover plate, chrome plated
Box 100 pz.

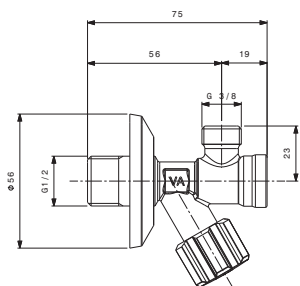

Cod.	Dim.	Kg/Pz.	Conf.	Pkg	Fin.	€
B402901	M1/2" x M3/8"	0,15	1		cr / chr	7,50



Rubinetto sottolavabo con filtro, vitone, maniglia ABS bianca, rosone inox, dado conico, cromato

Underbasin faucet with strainer, screw, white ABS handle, stainless steel rosette, conical nut, chrome plated

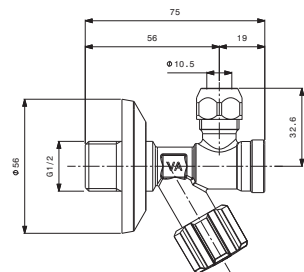

Cod.	Dim.	Kg/Pz.	Conf.	Pkg	Fin.	€
B402801	M1/2" x M3/8"	0,16			cr / chr	8,49



Rubinetto sottolavabo con filtro, vitone, maniglia ABS bianca, rosone inox, snodo e dado conico, cromato
Box 100 pz.

Filtered angle valve, multitem, ABS white handle, cover plate, with ball joint and compression nut, chrome plated
Box 100 pz.

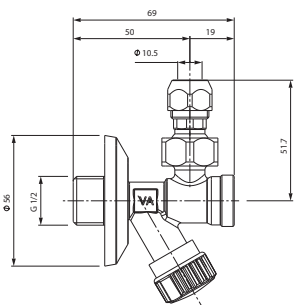

Cod.	Dim.	Kg/Pz.	Conf.	Pkg	Fin.	€
B401201	M1/2" x M3/8"	0,23	1		cr / chr	11,06

Rubinetti filtro / Filtered angle valves



Rubinetto sottolavabo con filtro, vitone, maniglia ABS, rosone inox, cromato
Box 100 pz.

Filtered angle valve, multitem, ABS handle, cover plate, chrome plated
Box 100 pz.

Cod.	Dim.	Kg/Pz.	Conf.	Pkg	Fin.	€
B402981	M1/2" x M3/8"	0,15	1		cr / chr	7,82
B401481	M1/2" x M1/2"	0,16	1		cr / chr	8,28

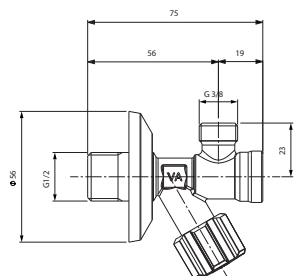

Rubinetto sottolavabo con filtro, vitone, maniglia ABS, rosone inox, dado conico, cromato
Box 100 pz.

Filtered angle valve, multitem, ABS handle, cover plate, compression nut, chrome plated
Box 100 pz.

Cod.	Dim.	Kg/Pz.	Conf.	Pkg	Fin.	€
B402881	M1/2" x M3/8"	0,16	1		cr / chr	8,63

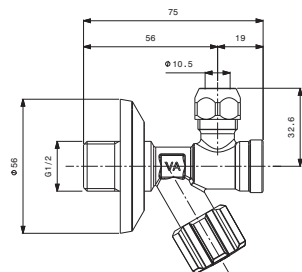

Rubinetto sottolavabo con filtro, vitone, maniglia ABS, rosone inox, snodo e dado conico, cromato
Box 100 pz.

Filtered angle valve, multitem, ABS handle, cover plate, with ball joint and compression nut, chrome plated
Box 100 pz.

Cod.	Dim.	Kg/Pz.	Conf.	Pkg	Fin.	€
B401281	M1/2" x M3/8"	0,23	1		cr / chr	11,24

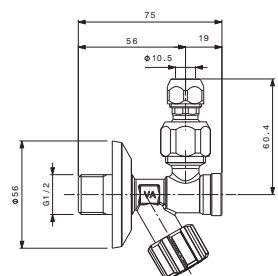

Rubinetti filtro / Filtered angle valves



Rubinetto sottolavabo
con filtro, vitone,
maniglia ottone,
rosone inox, cromato
Box 100 pz.

Filtered angle valve,
multiturn, brass handle,
cover plate, chrome
plated
Box 100 pz.

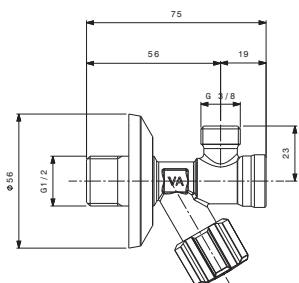

Cod.	Dim.	Kg/Pz.	Conf.	Pkg	Fin.	€
B402980	M1/2" x M3/8"	0,18	1		cr / chr	11,06



Rubinetto sottolavabo
con filtro, vitone,
maniglia ottone,
rosone inox, snodo e
dado conico, cromato
Box 100 pz.

Filtered angle valve,
multiturn, brass handle,
cover plate, with ball
joint and compression
nut, chrome plated
Box 100 pz.

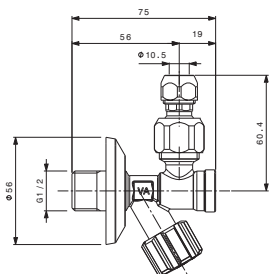

Cod.	Dim.	Kg/Pz.	Conf.	Pkg	Fin.	€
B401280	M1/2" x M3/8"	0,25	1		cr / chr	14,54

Rubinetti filtro / Filtered angle valves



Rubinetto sottolavabo con filtro, vitone resina anticalcare, maniglia ABS, rosone inox, cromato
Box 100 pz.

Filtered angle valve, multium resin anti-lime, ABS handle, cover plate, chrome plated
Box 100 pz.

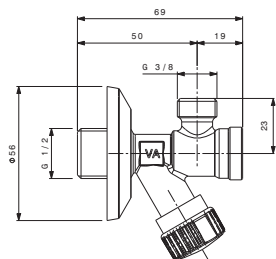

Cod.	Dim.	Kg/Pz.	Conf.	Pkg	Fin.	€
B392981	M1/2" x M3/8"	0,13	1		cr / chr	7,08



Rubinetto sottolavabo con filtro, vitone resina anticalcare, maniglia ABS, rosone inox, dado conico, cromato
Box 100 pz.

Filtered angle valve, multium resin anti-lime, ABS handle, cover plate, compression nut, chrome plated
Box 100 pz.

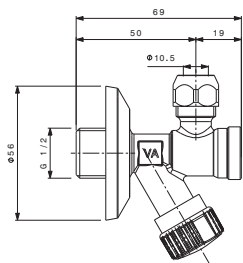

Cod.	Dim.	Kg/Pz.	Conf.	Pkg	Fin.	€
B392881	M1/2" x M3/8"	0,15	1		cr / chr	8,41



Rubinetto sottolavabo con filtro, vitone resina anticalcare, maniglia ABS, rosone inox, snodo e dado conico, cromato
Box 100 pz.

Filtered angle valve, multium resin anti-lime, ABS handle, cover plate, with ball joint and compression nut, chrome plated
Box 100 pz.

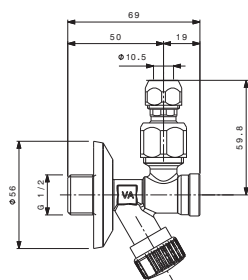

Cod.	Dim.	Kg/Pz.	Conf.	Pkg	Fin.	€
B391281	M1/2" x M3/8"	0,19	1		cr / chr	11,00

Rubinetti filtro / Filtered angle valves



Rubinetto sottolavabo a sfera con filtro, maniglia ABS, rosone inox, cromato
Box 100 pz.

Filtered angle ball valve, ABS handle, cover plate, chrome plated
Box 100 pz.

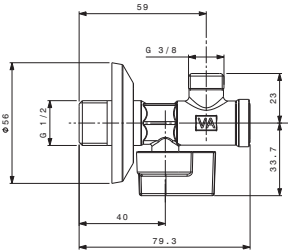

Cod.	Dim.	Kg/Pz.	Conf.	Pkg	Fin.	€
B462981	M1/2" x M3/8"	0,16	1		cr / chr	9,36
B461481	M1/2" x M1/2"	0,17	1		cr / chr	10,34



Rubinetto sottolavabo a sfera con filtro, maniglia ABS, rosone inox, dado conico alto, cromato
Box 100 pz.

Filtered angle ball valve, ABS handle, cover plate, compression nut, chrome plated
Box 100 pz.

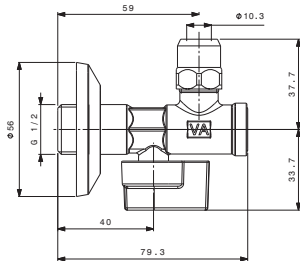

Cod.	Dim.	Kg/Pz.	Conf.	Pkg	Fin.	€
B467281	M1/2" x M3/8"	0,19	2		cr / chr	10,74



Rubinetto sottolavabo a sfera con filtro, maniglia ABS, rosone inox, snodo e dado conico, cromato
Box 50 pz.

Filtered angle ball valve, ABS handle, cover plate, with ball joint and compression nut, chrome plated
Box 50 pz.

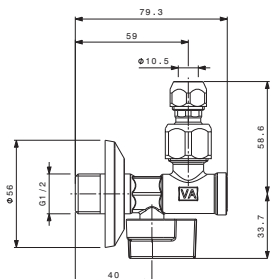

Cod.	Dim.	Kg/Pz.	Conf.	Pkg	Fin.	€
B461281	M1/2" x M3/8" x Ø10	0,23	1		cr / chr	13,30

Rubinetti filtro / Filtered angle valves



Raccordo con filtro
Maschio-Femmina,
dado conico alto,
cromato
Box 100 pz.

Adapter with filter Male-
Female, compression
nut, chrome plated
Box 100 pz.

Cod.	Dim.	Kg/Pz.	Conf.	Pkg	Fin.	€
B01201	M3/8" x F3/8"	0,12	1		cr / chr	10,94

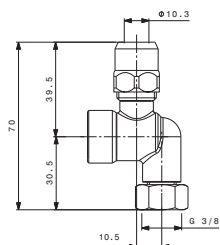

Filtro acciaio inox
Box 100 pz.

Stainless steel filter
Box 100 pz.

Cod.	Dim.	Kg/Pz.	Conf.	Pkg	Fin.	€
SL053.01	Ø15 H16 maniglia 0,6 mm Ø15 H16 width net 0,6 mm	0,00	10		inox / steel	0,30

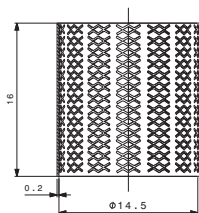

Tappo rubinetto filtro
con guarnizione
Box 100 pz.

Filter tap plug with
gasket
Box 100 pz.

Cod.	Kg/Pz.	Conf.	Pkg	Fin.	€
SL067.000	0,02	10		cr / chr	1,87

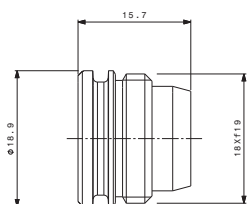

made in Italy



ALBERTONI

*La tecnologia che semplifica
dal 1961*

La serie di curvette sottolavabo, consentono una semplice e rapida installazione, dove non è necessario regolare e/o controllare il flusso dell'acqua.

The elbows series allows a simple and quick installation, where it is not necessary to adjust and/or control the flow of water.

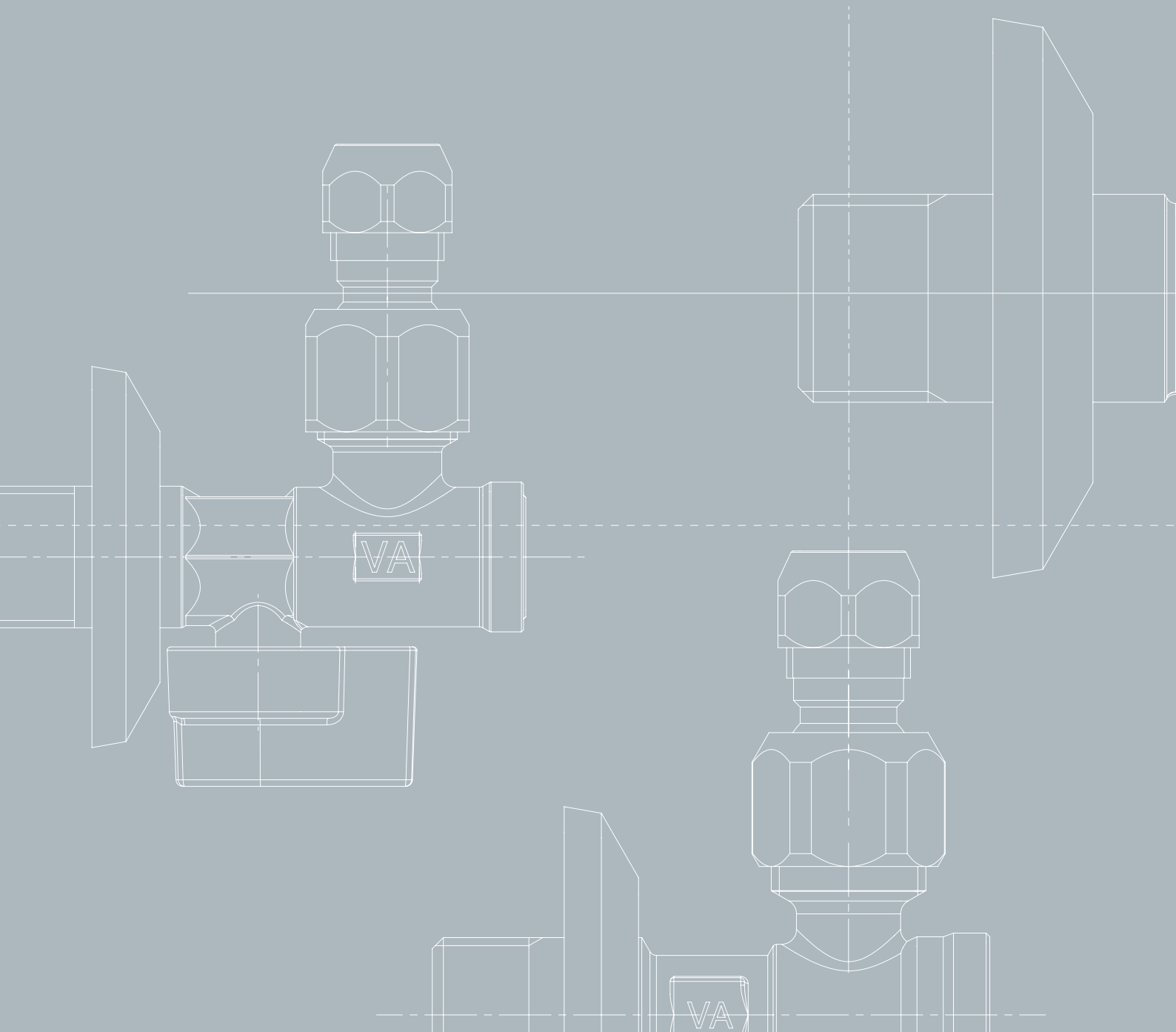

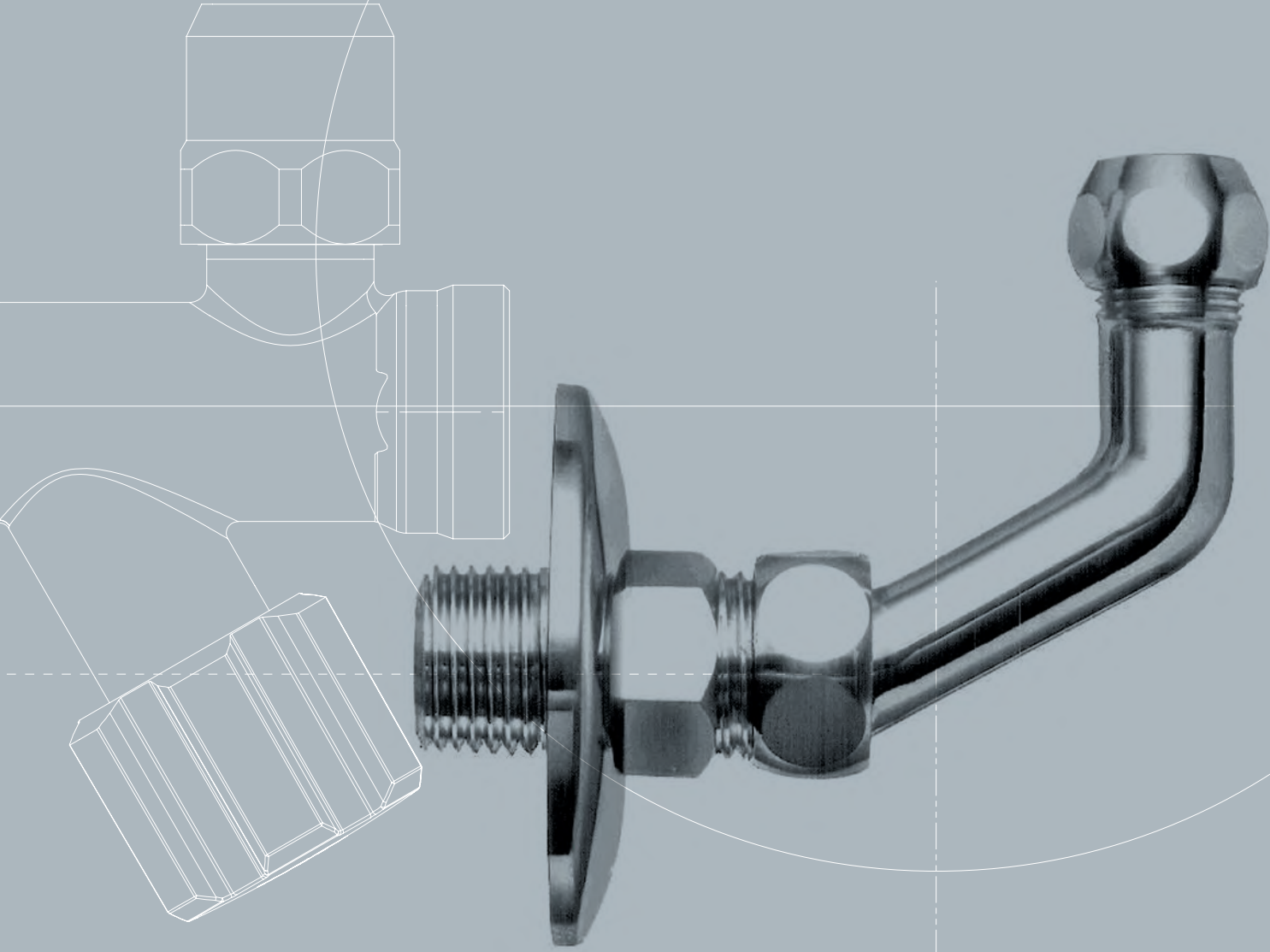

Curvette

Elbows



Curvette / Elbows

Curvetta 90° in ottone stampato, rosone inox, cromata
Box 100 pz.

Cod.	Dim.	Kg/Pz.	Conf.	Pkg	Fin.	€
G02803	M1/2" x M1/2"	0,11	1		cr / chr	4,78
G0280334	M1/2" x M3/4"	0,12	1		cr / chr	9,86



Elbow 90°, inox cover plate, chrome plated
Box 100 pz.

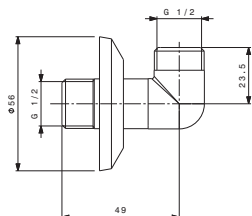

Curvetta 90° in ottone stampato, rosone inox, dado conico basso, cromata
Box 100 pz.

Cod.	Dim.	Kg/Pz.	Conf.	Pkg	Fin.	€
G02802	M1/2" x M3/8" x Ø10	0,12	1		cr / chr	6,56



Elbow 90°, inox cover plate, compression nut, chrome plated
Box 100 pz.

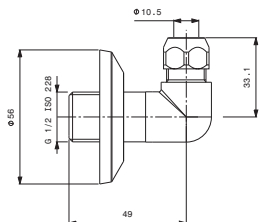

Curvetta 90° in ottone stampato, rosone inox, con snodo e dado conico basso, cromata
Box 100 pz.

Cod.	Dim.	Kg/Pz.	Conf.	Pkg	Fin.	€
G02823	M1/2" x M3/8" x Ø10	0,17	1		cr / chr	9,12



Elbow 90°, inox cover plate, with ball joint and compression nut, chrome plated
Box 100 pz.

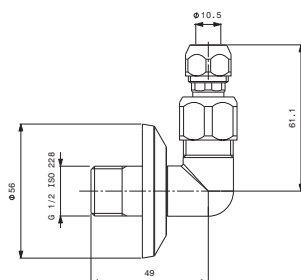

Curvette / Elbows



Curvetta 90° in ottone stampato, nipples, rosone inox, dado basso, cromata
Box 100 pz.

Elbow 90°, nipple, inox cover plate, compression nut, chrome plated
Box 100 pz.

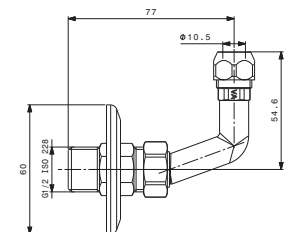

Cod.	Dim.	Kg/Pz.	Conf.	Pkg	Fin.	€
G02837	M3/8" x M3/8" x Ø10	0,14	2		cr / chr	8,49
G02838	M1/2" x M3/8" x Ø10	0,14	2		cr / chr	7,65



Curvetta 90° in ottone stampato, nipples, rosone inox, dado conico alto, cromata
Box 100 pz.

Elbow 90°, nipple, inox cover plate, compression nut, chrome plated
Box 100 pz.

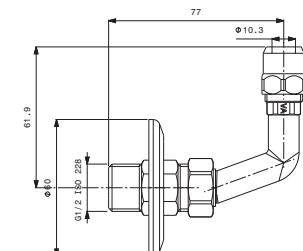

Cod.	Dim.	Kg/Pz.	Conf.	Pkg	Fin.	€
G02840	M1/2" x M3/8" x Ø10	0,15	2		cr / chr	8,51

Curvette / Elbows

Curvetta 45° in ottone stampato, rosone inox, dado conico basso, cromata
Box 100 pz.

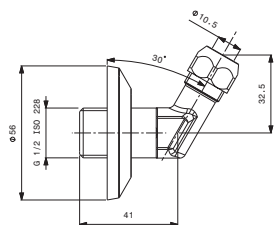

Elbow 45°, inox cover plate, compression nut, chrome plated
Box 100 pz.

Cod.	Dim.	Kg/Pz.	Conf.	Pkg	Fin.	€
G02806	M1/2" x M3/8" x Ø10	0,11	2		cr / chr	5,87

Curvetta 45° in ottone stampato, rosone inox, dado conico alto, cromata
Box 100 pz.

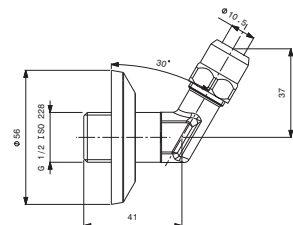

Elbow 45°, inox cover plate, compression nut, chrome plated
Box 100 pz.

Cod.	Dim.	Kg/Pz.	Conf.	Pkg	Fin.	€
G02807	M1/2" x M3/8" x Ø10	0,11	2		cr / chr	6,15

Prolunga H30 mm, dado conico basso, cromata
Box 100 pz.

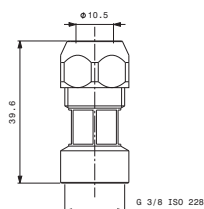

Extension H30 mm, compression nut, chrome plated
Box 100 pz.

Cod.	Dim.	Kg/Pz.	Conf.	Pkg	Fin.	€
G02818	M3/8" x F3/8" x Ø10	0,04	10		cr / chr	3,13
G02818SD	M3/8" x F3/8" senza dado M3/8" x F3/8" without nut	0,02	10		cr / chr	1,97

Curvette / Elbows



Raccordo diritto H40,
dado conico basso,
rosone esagonale
Box 100 pz.

Straight connection
nipple H40, with
compression nut and
cover plate
Box 100 pz.

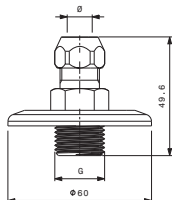

Cod.	Dim.	Kg/Pz.	Conf.	Pkg	Fin.	€
G02560	M3/8" x Ø10	0,07	1		cr / chr	4,94
G02561	M3/8" x Ø12	0,06	1		cr / chr	5,28
G02562	M1/2" x M3/8" x Ø10	0,08	1		cr / chr	4,46
G02563	M1/2" x M3/8" x Ø12	0,07	1		cr / chr	5,03
G02564	M1/2" x M3/8" x Ø14	0,08	1		cr / chr	5,06



Raccordo diritto H40,
senza dado, rosone
esagonale
Box 100 pz.

Straight fitting H40,
without nut, hexagonal
rosette
Box 100 pz.

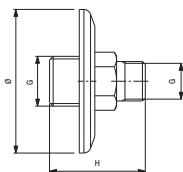

Cod.	Dim.	Kg/Pz.	Conf.	Pkg	Fin.	€
G02562SD	M1/2" x M3/8"	0,07	1		cr / chr	3,26



Raccordo diritto H40
Box 100 pz.

Straight fitting H40
Box 100 pz.

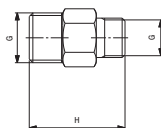

Cod.	Dim.	Kg/Pz.	Conf.	Pkg	Fin.	€
G0256205	M1/2" x M3/8"	0,06	1		cr / chr	2,90

Curvette / Elbows



Raccordo diritto H50, dado conico basso, rosone esagonale
Box 100 pz.

Straight connection nipple H50, with compression nut and cover plate
Box 100 pz.

Cod.	Dim.	Kg/Pz.	Conf.	Pkg	Fin.	€
G025650	M3/8" x Ø10	0,05	1		cr / chr	5,23

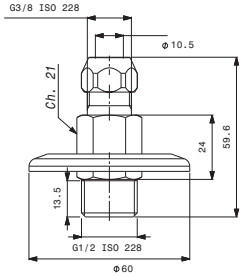

Raccordo diritto H50, senza dado, rosone esagonale
Box 100 pz.

Straight fitting H40, without nut, hexagonal rosette
Box 100 pz.

Cod.	Dim.	Kg/Pz.	Conf.	Pkg	Fin.	€
G025650SD	M1/2" x M3/8"	0,05	1		cr / chr	4,10

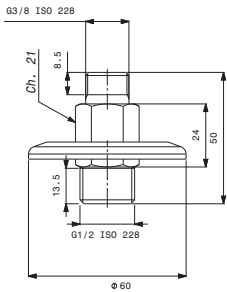



made in Italy



La tecnologia che semplifica
dal 1961

La serie di rubinetti lavatrice viene proposta in un'ampia gamma di soluzioni per qualsiasi necessità di installazione. Utilizzata principalmente per allacciamenti idraulici a lavatrici e lavastoviglie.

Angle valves for washing machine are offered in a wide range of solutions for any installation requirement. Mainly used for hydraulic connections to washing machine and dishwashers.

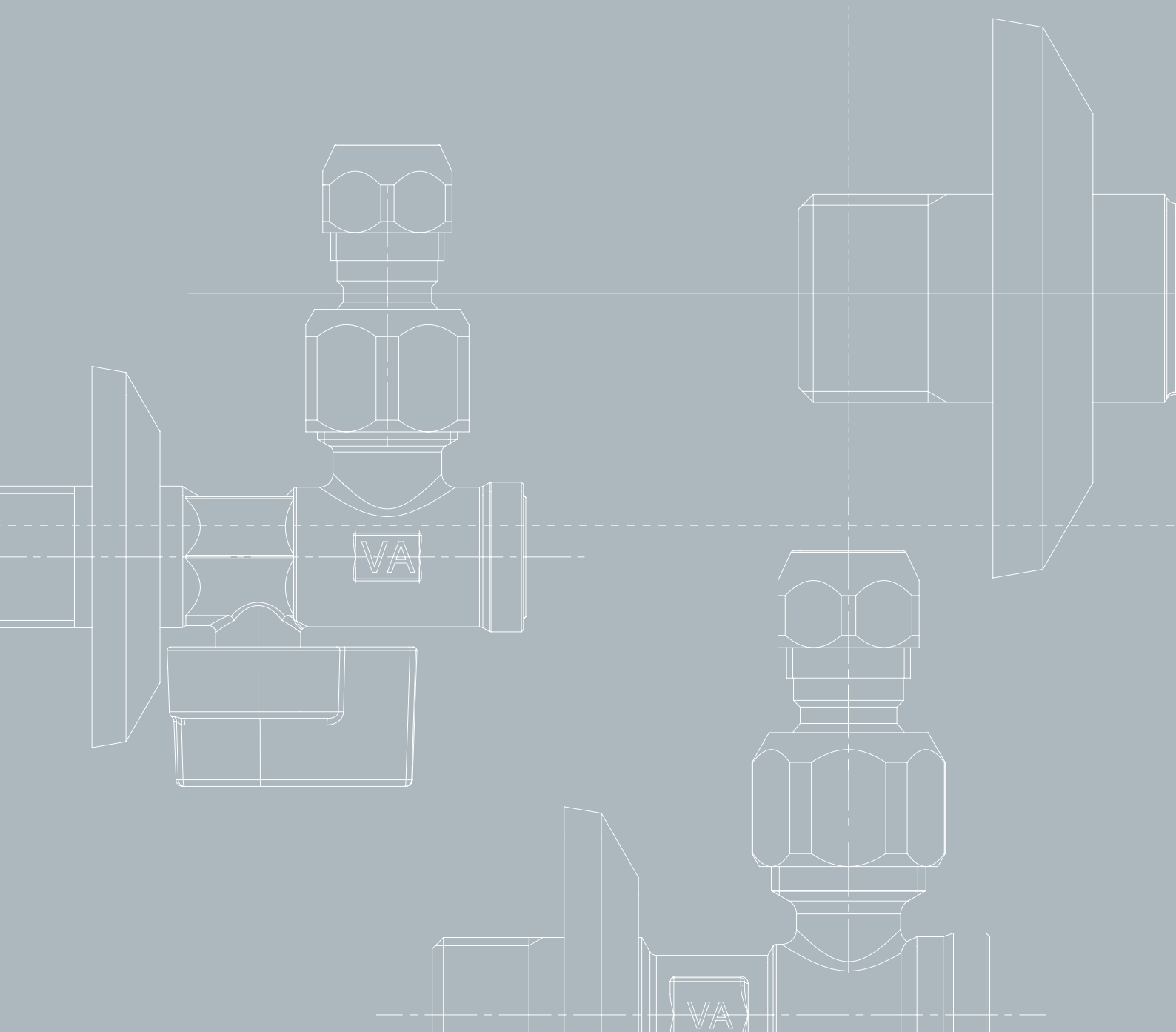

Rubinetti lavatrice

Angle valves for
washing machine

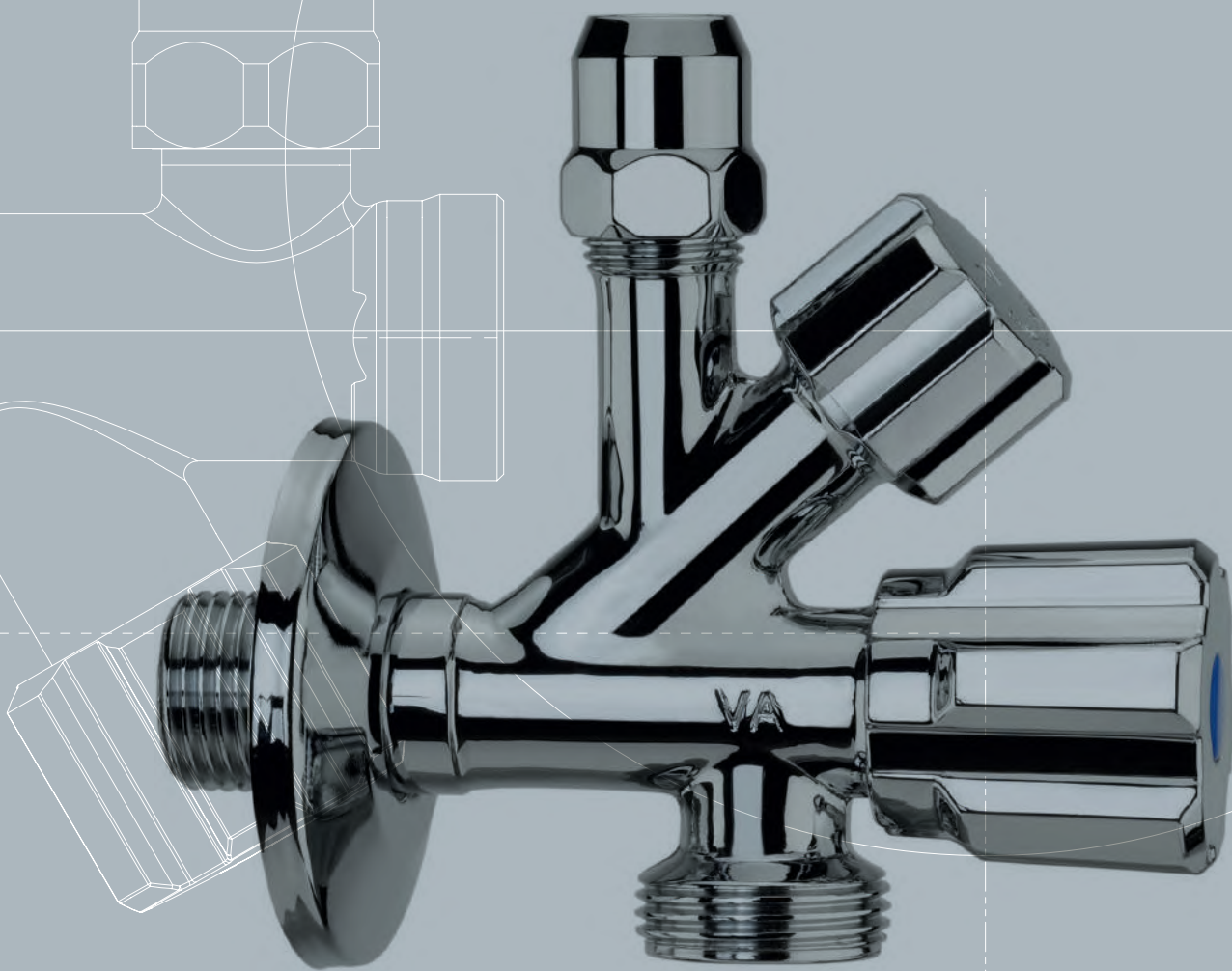

Rubinetti lavatrice / Angle valves for washing machine



Rubinetto combinato lavatrice con filtro incorporato al vitone, vitone brevettato n°22566 B/65, maniglie ABS, dado conico alto, rosone inox, cromato
Box 50 pz.

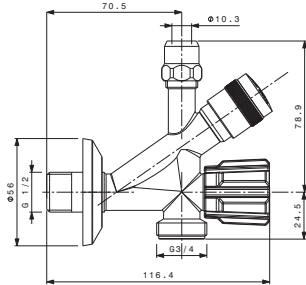

Washing machine double angle valve with filtered spindle, multium brass spindle, patented n°22566 B/65, ABS handles, compression nut, inox cover plate, chrome plated
Box 50 pz.

Cod.	Dim.	Kg/Pz.	Conf.	Pkg	Fin.	€
D9034851	M1/2" x M3/4"	0,41	1		cr / chr	33,43



Rubinetto combinato lavatrice con filtro incorporato al vitone, vitone brevettato n°22566 B/65, maniglie ABS, snodo e dado conico alto, rosone inox, cromato
Box 50 pz.

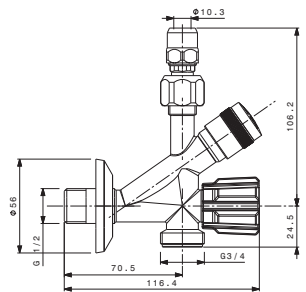

Washing machine combo angle valve with filter incorporated to the spindle, patented spindle, ABS handles, high conical nut, stainless steel rosette, chrome plated
Box 50 pz.

Cod.	Dim.	Kg/Pz.	Conf.	Pkg	Fin.	€
D903585	M1/2" x M3/4"	0,49	1		cr / chr	42,21



Rubinetto mono lavatrice con filtro, vitone ottone, maniglia ABS, rosone inox, cromato
Box 30 pz.

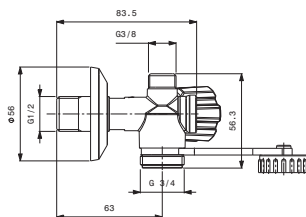

Washing machine mono angle valve with filter, multium brass spindle, ABS handle, inox cover plate, chrome plated
Box 30 pz.

Cod.	Dim.	Kg/Pz.	Conf.	Pkg	Fin.	€
D912285SD	M1/2" x M3/4"	0,35	1		cr / chr	24,37

Rubinetti lavatrice / Angle valves for washing machine



Rubinetto combinato lavatrice, vitone ottone, maniglie ABS, dado conico alto, rosone inox, cromato
Box 50 pz.

Cod.	Dim.	Kg/Pz.	Conf.	Pkg	Fin.	€
D902385	M1/2 x M3/4"	0,29	1		cr / chr	16,04

Washing machine double spindle angle valve, multitem brass spindle, ABS handles, compression nut, inox cover plate, chrome plated
Box 50 pz.

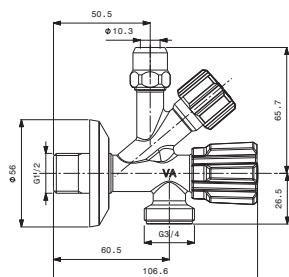

Rubinetto combinato lavatrice, vitone ottone, maniglie ABS, dado conico basso, rosone inox, cromato
Box 50 pz.

Cod.	Dim.	Kg/Pz.	Conf.	Pkg	Fin.	€
D902285	M1/2 x M3/4"	0,26	1		cr / chr	15,57

Washing machine combo angle valve, brass spindle, ABS handles, high conical nut, stainless rosette, chrome plated
Box 50 pz.

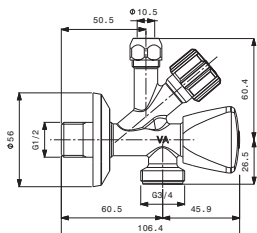

Rubinetto combinato lavatrice, vitone ottone, maniglie ABS, rosone inox, cromato
Box 50 pz.

Cod.	Dim.	Kg/Pz.	Conf.	Pkg	Fin.	€
D902285SD	M1/2 x M3/4"	0,25	1		cr / chr	14,51

Washing machine double spindle angle valve, multitem brass spindle, ABS handles, inox cover plate, chrome plated
Box 50 pz.

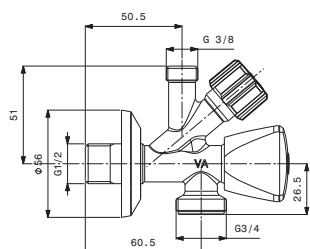

Rubinetti lavatrice / Angle valves for washing machine



Rubinetto combinato lavatrice, vitone ottone antiritorno, maniglie ABS, dado conico alto, ghiera e portagomma, rosone inox, cromato
Box 50 pz.

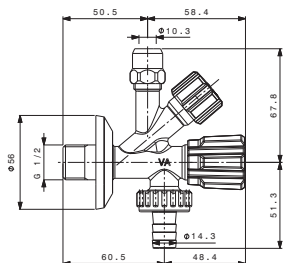

Washing machine double spindle angle valve, multitem brass spindle, ABS handles, compression nut, hose union, inox cover plate, chrome plated
Box 50 pz.

Cod.	Dim.	Kg/Pz.	Conf.	Pkg	Fin.	€
D901885	M3/8" x M3/4"	0,33	1		cr / chr	19,31
D902085	M1/2" x M3/4"	0,30	1		cr / chr	18,00



Rubinetto combinato lavatrice, vitone ottone antireflusso, maniglie ABS, dado conico alto, rosone inox, cromato
Box 50 pz.

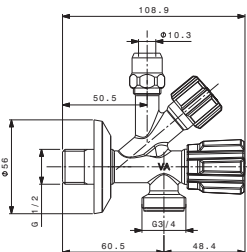

Washing machine double spindle angle valve, multitem no back flow spindle, ABS handles, compression nut, inox cover plate, chrome plated
Box 50 pz.

Cod.	Dim.	Kg/Pz.	Conf.	Pkg	Fin.	€
D9021851	M1/2 x M3/4"	0,29	1		cr / chr	17,18



Rubinetto combinato lavatrice, vitone ottone, maniglie ABS, rosone inox, con vitone antireflusso, cromato
Box 50 pz.

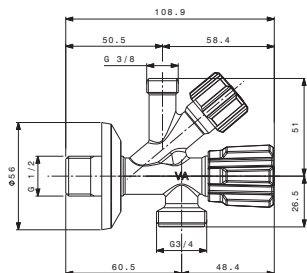

Washing machine combo angle valve, brass spindle, ABS handles, stainless steel rosette, with backflow preventer, chrome plated
Box 50 pz.

Cod.	Dim.	Kg/Pz.	Conf.	Pkg	Fin.	€
D9021851SD	M1/2 x M3/4"	0,27	1		cr / chr	16,00



Rubinetti lavatrice / Angle valves for washing machine



Rubinetto combinato lavatrice, vitone ottone, maniglie ABS, dado conico alto, rosone inox, anello di tenuta PTFE, vitone antiriflusso, cromato
Box 50 pz.

Washing machine double spindle angle valve, multium no back flow spindle, ABS handles, compression nut, inox cover plate, sealing PTFE ring, chrome plated
Box 50 pz.

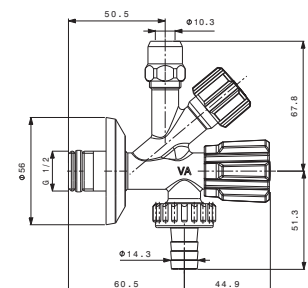

Cod.	Dim.	Kg/Pz.	Conf.	Pkg	Fin.	€
D9028851	M1/2" x M3/4"	0,30	1		cr / chr	20,76



Rubinetto combinato lavatrice, vitone ottone, maniglie ABS, dado conico alto, ghiera e portagomma, con aeratore anivuto antiritorno, rosone inox, cromato
Box 50 pz.

Washing machine double spindle angle valve, multium brass spindle, ABS handles, compression nut, hose union, inox cover plate, chrome plated
Box 50 pz.

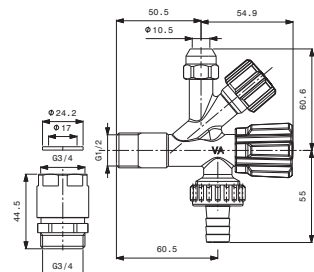

Cod.	Dim.	Kg/Pz.	Conf.	Pkg	Fin.	€
D900085	M1/2" x M3/8" x M3/4"	0,43	1		cr / chr	39,99



Rubinetto combinato lavatrice, vitone ottone, maniglie ottone, rosone inox, cromato
Box 50 pz.

Washing machine combo faucet, brass viton, brass handles, stainless rosette, chrome plated
Box 50 pz.

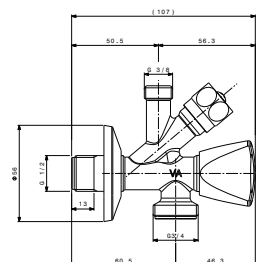

Cod.	Dim.	Kg/Pz.	Conf.	Pkg	Fin.	€
D902380SD	M1/2" x M3/8"	1,00	1		cr / chr	21,87

Rubinetti lavatrice / Angle valves for washing machine



Rubinetto combinato lavatrice leggero, vitone ottone, maniglie ABS, rosone inox, cromato
Box 50 pz.

Washing machine double spindle light angle valve, multiturn brass spindle, ABS handles, inox cover plate, chrome plated
Box 50 pz.

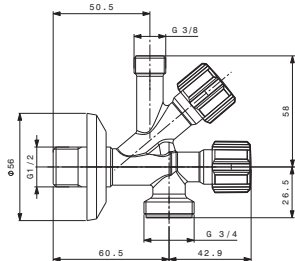

Cod.	Dim.	Kg/Pz.	Conf.	Pkg	Fin.	€
D902594	M1/2" x M3/8" x M3/4"	0,26	1		cr / chr	13,53
D902694	M1/2" x M1/2" x M3/4"	0,26	1		cr / chr	14,33



Rubinetto combinato lavatrice leggero, vitone ottone, maniglie ABS bianche, rosone inox, cromato
Box 50 pz.

Washing machine double spindle light angle valve, multiturn brass spindle, ABS white handles, inox cover plate, chrome plated
Box 50 pz.

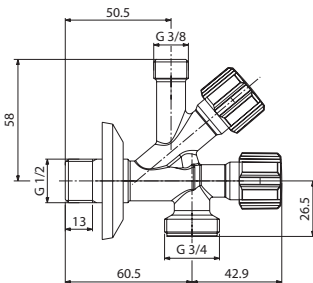

Cod.	Dim.	Kg/Pz.	Conf.	Pkg	Fin.	€
D902594WR	M1/2" x M3/8" x M3/4"	0,26	1		cr / chr	13,53



Rubinetto mono lavatrice, vitone ottone, maniglia ABS, rosone inox, con tappo ottone 3/4 e laccio, senza dado, sabbato cromato
Box 50 pz.

Single washing machine faucet, brass headcap, ABS handle, stainless steel rosette, with 3/4 brass cap and lace, without nut, sandblasted chrome
Box 50 pz.

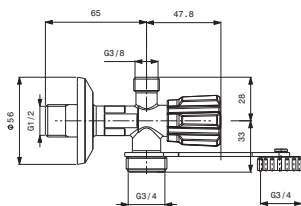

Cod.	Dim.	Kg/Pz.	Conf.	Pkg	Fin.	€
D916485	M1/2" x M3/8" x M3/4"	0,32	1		cr / chr	14,98

Rubinetti lavatrice / Angle valves for washing machine

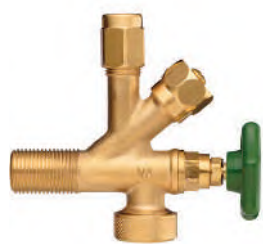

Rubinetto combinato lavatrice, vitone ottone, maniglia ottone e manettino colorato, tappo 3/4, dado conico alto, giallo sabbato
Box 50 pz.

Cod.	Dim.	Kg/Pz.	Conf.	Pkg	Fin.	€
E134465	M3/8" x M3/8" x Ø10 x M3/4"	0,34	1		gg s / br s	27,46
E134466	M1/2" x M3/8" x Ø10 x M3/4"	0,33	1		gg s / br s	22,10

Washing machine double spindle angle valve, multium brass spindle, brass handle and round handle colored, plug 3/4, compression nut, sand-blasted brass
Box 50 pz.

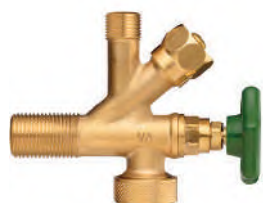
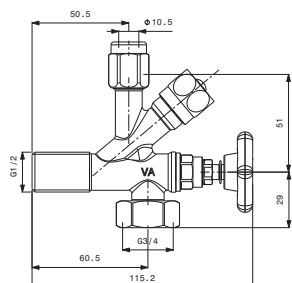

Rubinetto combinato lavatrice, vitone ottone, maniglia ottone e manettino nylon colorato, tappo 3/4, giallo sabbato
Box 50 pz.

Cod.	Dim.	Kg/Pz.	Conf.	Pkg	Fin.	€
E134466SD	M1/2" x M3/8" x M3/4"	0,30	1		gg s / br s	20,80

Washing machine double spindle angle valve, multium brass spindle, brass handle and round handle colored, plug 3/4, sand-blasted brass
Box 50 pz.

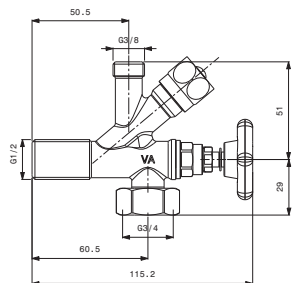

Rubinetto combinato lavatrice, vitone ottone, maniglie ABS, giallo sabbato
Box 50 pz.

Cod.	Dim.	Kg/Pz.	Conf.	Pkg	Fin.	€
D902285GGSD	M1/2" x M3/8" x M3/4"	0,25	1		gg s / br s	15,06

Washing machine combo faucet, brass viton, ABS handles, stainless steel rosette, sandblasted yellow
Box 50 pz.

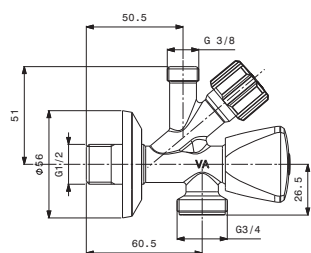

Rubinetti lavatrice / Angle valves for washing machine



Rubinetto doppio lavatrice, vitoni ottone, maniglie ABS, portagomma, cromato
Box 50 pz.

Washing machine double spindle angle valve, multitem brass spindle, ABS handles, hose union, chrome plated
Box 50 pz.

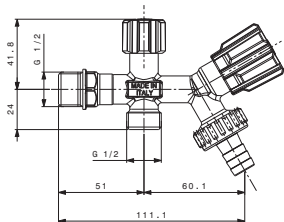

Cod.	Dim.	Kg/Pz.	Conf.	Pkg	Fin.	€
D443085	M1/2" x M1/2" x M3/4"	0,28	1		cr / chr	20,12
D443385	M1/2" x M3/4" x M3/4"	0,29	1		cr / chr	20,10



Rubinetto doppio lavatrice, vitoni ottone, maniglie ABS, cromato
Box 50 pz.

Double washing machine faucet, brass vitons, ABS handles, chrome plated
Box 50 pz.

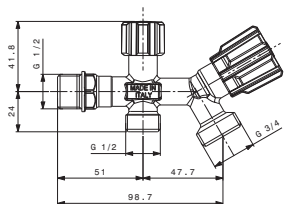

Cod.	Dim.	Kg/Pz.	Conf.	Pkg	Fin.	€
D443185	M1/2" x M1/2" x M3/4"	0,35	1		cr / chr	18,00
D443285	M1/2" x M3/4" x M3/4"	0,36	1		cr / chr	18,00

Rubinetti lavatrice / Angle valves for washing machine



Rubinetto doppio, vitone ottone, maniglie triangolari ABS, areatore, con portagomma, cromato Box 36 pz.

Cod.	Dim.	Kg/Pz.	Conf.	Pkg	Fin.	€
D920085	M1/2 x M3/4"	0,48	1		cr / chr	40,30

Washing machine double angle valve, multitem brass spindle, ABS triangular handles, areators, hose union, chrome plated Box 36 pz.

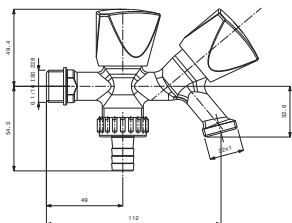

Rubinetto doppio, vitone ottone, maniglie triangolari ABS, areatore, cromato Box 36 pz.

Cod.	Dim.	Kg/Pz.	Conf.	Pkg	Fin.	€
D920185	M1/2 x M3/4"	0,47	1		cr / chr	39,67

Washing machine double angle valve, multitem brass spindle, ABS triangular handles, areators, chrome plated Box 36 pz.

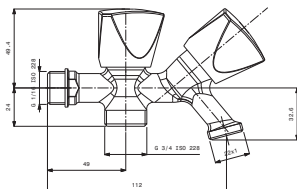

Rubinetti lavatrice / Angle valves for washing machine

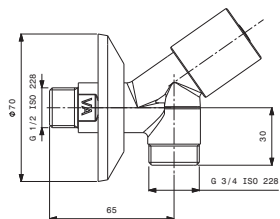

Rubinetto lavatrice LINEA, vitone ottone, maniglia ottone, rosone ottone, cromato
Box 50 pz.

Washing machine angle valve LINEA, multitem brass spindle, brass handle, brass cover plate, chrome-plated
Box 50 pz.

Cod.	Dim.	Kg/Pz.	Conf.	Pkg	Fin.	€
D911500	M1/2" x M3/4"	0,48	1		cr / chr	36,70

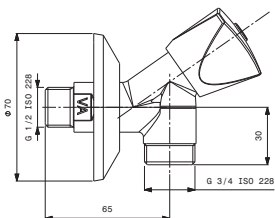

Rubinetto lavatrice, vitone ottone, maniglia triangolare ottone, rosone ottone, lucidato e cromato
Box 50 pz.

Washing machine angle valve, multitem brass spindle, brass triangular handle, brass cover plate, chrome-plated
Box 50 pz.

Cod.	Dim.	Kg/Pz.	Conf.	Pkg	Fin.	€
D911585	M1/2" x M3/4"	0,39	1		cr / chr	29,37

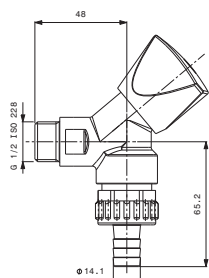

Rubinetto lavatrice con areatore antivuloto antiritorno, vitone ottone, maniglia triangolare ottone, con portagomma, cromato
Box 50 pz.

Washing machine angle valve with no backflow no return aerator, multitem brass spindle, brass triangular handle, with hose union, chrome-plated
Box 50 pz.



Cod.	Dim.	Kg/Pz.	Conf.	Pkg	Fin.	€
D903185	M1/2" x M3/4"	0,33	1		cr / chr	33,92

Rubinetti lavatrice / Angle valves for washing machine



Rubinetto lavatrice,
vitone ottone, maniglia
ABS, cromato
Box 50 pz.

Washing machine angle
valve, multitem brass
spindle, brass handle,
chrome plated
Box 50 pz.

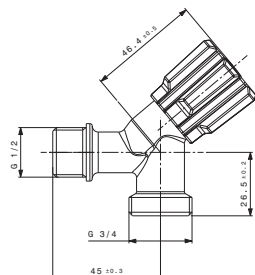

Cod.	Dim.	Kg/Pz.	Conf.	Pkg	Fin.	€
D905385	M1/2" x M3/4"	0,18	1		cr / chr	12,89



Rubinetto lavatrice,
vitone ottone, maniglia
ABS, con rosone,
cromato
Box 50 pz.

Washing machine angle
valve, multitem brass
spindle, brass handle,
cover plate, chrome
plated
Box 50 pz.

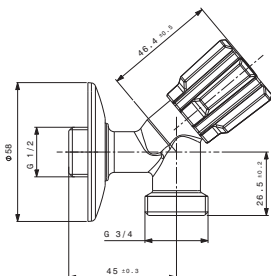

Cod.	Dim.	Kg/Pz.	Conf.	Pkg	Fin.	€
D905385R	M1/2" x M3/4"	0,18	1		cr / chr	13,68



Rubinetto
lavatrice, vitone
ottone antiritorno,
maniglia ABS, con
portagomma, cromato
Box 50 pz.

Washing machine angle
valve, multitem no back
flow spindle, brass
handle, hose union,
chrome plated
Box 50 pz.

Cod.	Dim.	Kg/Pz.	Conf.	Pkg	Fin.	€
D904885	M3/8" x M3/4"	0,39	1		cr / chr	12,70
D905085	M1/2" x M3/4"	0,18	1		cr / chr	14,35

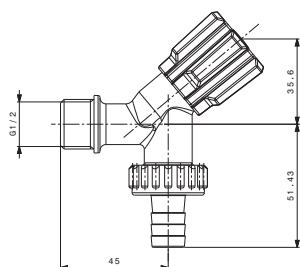

Rubinetti lavatrice / Angle valves for washing machine



Rubinetto lavatrice,
vitone ottone, maniglia
ABS, rosone inox,
cromato
Box 100 pz.

Cod.	Dim.	Kg/Pz.	Conf.	Pkg	Fin.	€
D914689	M1/2" x M3/4"	0,14	1		cr / chr	7,37

Washing machine angle
valve, multitem brass
spindle, ABS handle,
inox cover plate, chrome
plated
Box 100 pz.

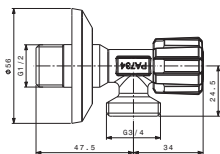

Rubinetto diritto
lavatrice, maniglia
ABS, vitone ottone
antiritorno, cromato
Box 50 pz.

Cod.	Dim.	Kg/Pz.	Conf.	Pkg	Fin.	€
D904185	M1/2" x M3/4"	0,14	1		cr / chr	11,65

Washing machine angle
valve, multitem no
back flow spindle, ABS
handle, chrome plated
Box 50 pz.

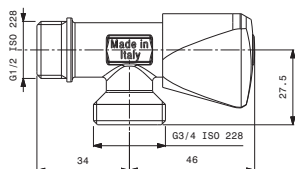

Rubinetto diritto
lavatrice, maniglia
ABS, vitone ottone,
cromato
Box 50 pz.

Cod.	Dim.	Kg/Pz.	Conf.	Pkg	Fin.	€
D904689	M1/2" x M3/4"	0,15	1		cr / chr	10,07

Washing machine angle
valve, multitem brass
spindle, ABS handle,
chrome plated
Box 50 pz.

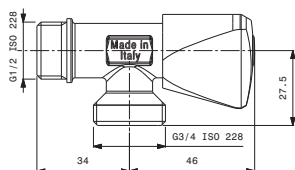

Rubinetti lavatrice / Angle valves for washing machine



Rubinetto per lavatrice verticale, vitone ottone, maniglia ABS, cromato
Box 50 pz.

Upright washing machine angle valve, brass spindle, ABS handle, chrome plated
Box 50 pz.

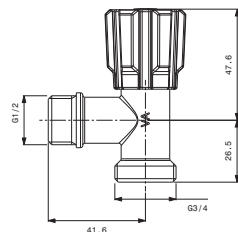

Cod.	Dim.	Kg/Pz.	Conf.	Pkg	Fin.	€
D906089	M3/8" x M3/4"	0,15	1		cr / chr	12,98
D906189	M1/2" x M3/4"	0,15	1		cr / chr	12,25



Rubinetto lavatrice con filtro, vitone ottone, maniglia ABS, rosone inox, cromato
Box 50 pz.

Washing machine angle valve with filter, multitem brass spindle, ABS handle, inox cover plate, chrome plated
Box 50 pz.

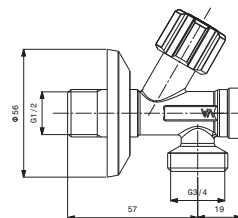

Cod.	Dim.	Kg/Pz.	Conf.	Pkg	Fin.	€
B144587	M1/2" x M3/4"	0,20	1		cr / chr	11,59

Rubinetti lavatrice / Angle valves for washing machine



Rubinetto lavatrice a sfera, maniglia ottone, rosone ottone, cromato
Box 50 pz.

Washing machine ball angle valve, brass handle, brass cover plate, chrome-plated
Box 50 pz.

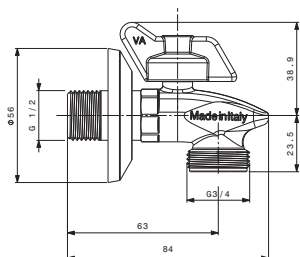

Cod.	Dim.	Kg/Pz.	Conf.	Pkg	Fin.	€
D909000	M1/2" x M3/4"	0,24	1		cr / chr	16,30



Rubinetto lavatrice a sfera LINEA, maniglia ottone, rosone ottone, cromato
Box 50 pz.

Washing machine ball angle valve LINEA, brass handle, brass cover plate, chrome-plated
Box 50 pz.

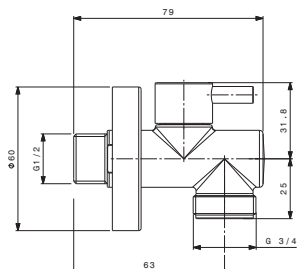

Cod.	Dim.	Kg/Pz.	Conf.	Pkg	Fin.	€
L906773	M1/2" x M3/4"	0,32	1		cr / chr	31,99



Rubinetto lavatrice a sfera, maniglia ABS, rosone inox, cromato
Box 100 pz.

Washing machine ball angle valve, ABS handle, inox cover plate, chrome plated
Box 100 pz.

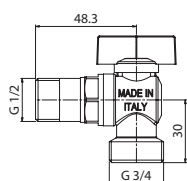

Cod.	Dim.	Kg/Pz.	Conf.	Pkg	Fin.	€
D906773	M1/2" x M3/4"	0,16	1		cr / chr	8,97
D9067733	M3/8" x M3/4"	0,16	1		cr / chr	9,41

Rubinetti lavatrice / Angle valves for washing machine



Rubinetto lavatrice a sfera, maniglia ABS, rosone inox, cromato
Box 100 pz.

Washing machine ball angle valve, ABS handle, inox cover plate, chrome plated
Box 100 pz.

Cod.	Dim.	Kg/Pz.	Conf.	Pkg	Fin.	€
D909073	M1/2" x M3/4"	0,13	1		cr / chr	7,79

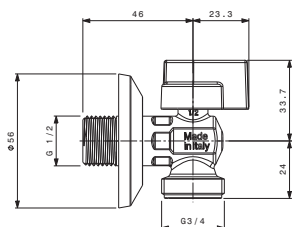

Rubinetto lavatrice a sfera, maniglia ABS, rosone inox, con valvola antiritorno, cromato
Box 100 pz.

Washing machine ball angle valve, no back flow device, ABS handle, inox cover plate, chrome plated
Box 100 pz.

Cod.	Dim.	Kg/Pz.	Conf.	Pkg	Fin.	€
D909073R	M1/2" x M3/4"	0,12	1		cr / chr	11,99

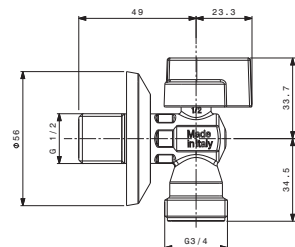

Rubinetti lavatrice / Angle valves for washing machine



Rubinetto per lavatrice a tre vie, vitone ottone, maniglia ABS, cromato
Box 50 pz.

Three way washing machine angle valve, brass multitem spindle, chrome plated
Box 50 pz.

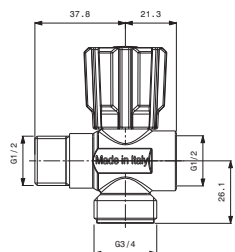

Cod.	Dim.	Kg/Pz.	Conf.	Pkg	Fin.	€
D906489	M1/2" x F1/2" x M3/4"	0,19	1		cr / chr	10,78



Rubinetto di derivazione per lavatrice, vitone ottone con antiriflusso, maniglia ABS, dado conico alto, portagomma, cromato
Box 50 pz.

Derivation washing machine angle valve, brass spindle with no back-flow device, compression nut, hose union, chrome plated
Box 50 pz.

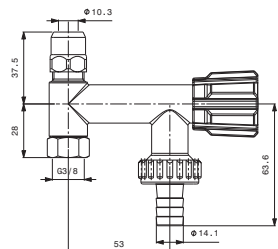

Cod.	Kg/Pz.	Conf.	Pkg	Fin.	€
D9010851	0,31	1		cr / chr	24,54



Rubinetto di derivazione per lavatrice, vitone ottone con antiriflusso, maniglia ABS, dado conico alto, cromato
Box 50 pz.

Derivation washing machine angle valve, brass spindle with no back-flow device, compression nut, chrome plated
Box 50 pz.

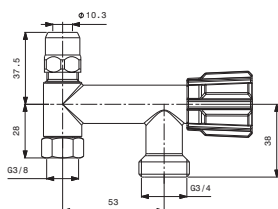

Cod.	Kg/Pz.	Conf.	Pkg	Fin.	€
D9011851	0,30	1		cr / chr	24,03

Rubinetti lavatrice / Angle valves for washing machine



Rubinetto per lavatrice a tre vie, vitone ottone, maniglia triangolare ABS, portagomma, cromato
Box 25 pz.

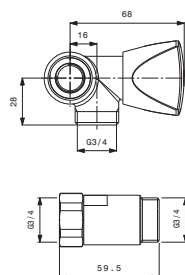

Three way washing machine angle valve, brass multitem spindle, ABS triangular handle, chrome plated
Box 25 pz.

Cod.	Dim.	Kg/Pz.	Conf.	Pkg	Fin.	€
D913485	F3/4" x M3/4" maniglia DX F3/4" x M3/4" handle DX	0,58	1		cr / chr	42,98
D913685	F3/4" x M3/4" maniglia SX F3/4" x M3/4" handle SX	0,52	1		cr / chr	48,19



Distanziale con dado girevole singolo, H45 mm, cromato
Box 50 pz.

Brass extension with swivel nut, H45, chrome plated
Box 50 pz.

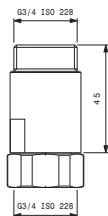

Cod.	Dim.	Kg/Pz.	Conf.	Pkg	Fin.	€
G03700	3/4" x 3/4"	0,19	1		cr / chr	15,02
G03701	1/2" x 1/2"	0,17	1		cr / chr	12,77
K003478	3/4" x 3/4" foro filettato 3/8" 3/4" x 3/4" threaded hole 3/8"	0,17	1		cr / chr	16,49



Coppia di distanziali per gruppi, in ottone, con calotta girevole e attacco da 3/8 cromato
Box 50 pz.

Couple brass extension for wall mixer, with swivel nut
Box 50 pz.

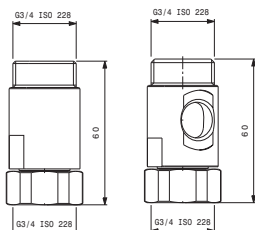

Cod.	Dim.	Kg/Pz.	Conf.	Pkg	Fin.	€
K003379	3/4" x 3/4"	0,36	1		cr / chr	30,03

Rubinetti lavatrice / Angle valves for washing machine



Raccordo MF 3/4 con
antivuoto antiritorno
Box 100 pz.

No back flow connector
Box 100 pz.

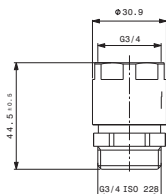

Cod.	Dim.	Kg/Pz.	Conf.	Pkg	Fin.	€
K12242	M3/4" x F3/4"	0,08	1		cr / chr	21,39



Raccordo antiritorno,
maschio femmina,
cromato.
Box 250 pz.

No return bushing,
male-female, chromed
Box 250 pz.

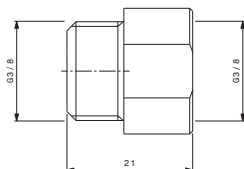

Cod.	Dim.	Kg/Pz.	Conf.	Pkg	Fin.	€
JAK0001	M3/8" x F3/8"	0,03	1		cr / chr	4,30
JAK0002	M1/2" x F1/2"	0,05	1		cr / chr	8,44



Valvola
antiallagamento,
nylon, attacchi da 3/4"
maschio-femmina
Box 200 pz.

Overflow safety valve
Box 200 pz.

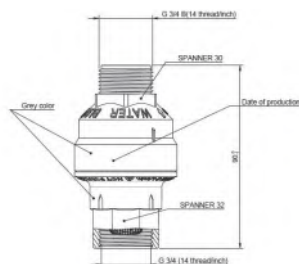

Cod.	Dim.	ø mm	Kg/Pz.	Conf.	Pkg	€
K100041	M3/4" x F3/4"	10	0,09	1		30,51

Rubinetti lavatrice / Angle valves for washing machine



Ghiera e portagomma
Box 100 pz.

Hose union kit
Box 100 pz.

Cod.	Dim.	ø mm	Kg/Pz.	Conf.	Pkg	€
G003299	3/4"	10	0,01	5		0,79

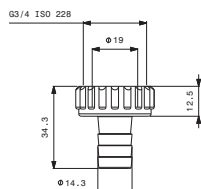

Vitone con broccia
8x20
Box 100 pz.

Spindle brass 8x20
Box 100 pz.

Cod.	Dim.	Kg/Pz.	Conf.	Pkg	Fin.	€
SL028.043	3/8"	0,04	10		gg / br raw	3,49
SL028.0437	1/2"	0,06	10		gg / br raw	5,31

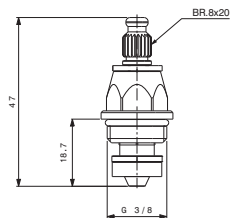

Vitone antiritorno, con
broccia 8x20
Box 100 pz.

Spindle brass 8x20 with
no back flow spring
Box 100 pz.

Cod.	Dim.	Kg/Pz.	Conf.	Pkg	Fin.	€
SL028.0435	1/2"	0,07	10		gg / br raw	9,06
SL028.049	3/8"	0,04	10		gg / br raw	4,30

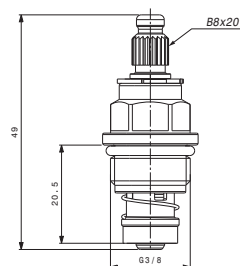

Rubinetti lavatrice / Angle valves for washing machine



Maniglia triangolare,
broccia 8x20
Box 100 pz.

Handle triangular ABS
8x20
Box 100 pz.

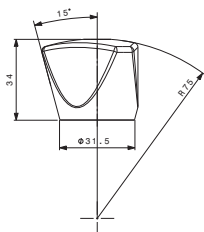

Cod.	Dim.	Kg/Pz.	Conf.	Pkg	Fin.	€
R181086	3/8"	0,00	10		cr / chr	3,41
SL033.015	1/2"	0,02	10		cr / chr	4,85



Maniglia ABS, broccia
8x20
Box 100 pz.

Handle ABS 8x20
Box 100 pz.

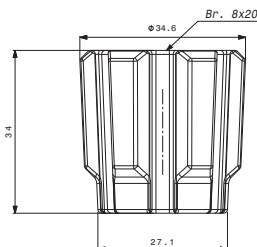

Cod.	Dim.	Kg/Pz.	Conf.	Pkg	Fin.	€
R181075	3/8"	0,02	10		cr / chr	1,71
R1810855	1/2"	0,02	10		cr / chr	2,57
R181085	3/8"	0,01	10		cr / chr	2,10



Segnalatori per
aggancio maniglia
Box 500 pz.

handle indicy
Box 500 pz.

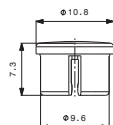

Cod.	Dim.	Kg/Pz.	Conf.	Pkg	€
SL054.20	Blu Blue	0,00	50		0,10
SL054.205	Rosso Red	0,00	50		0,10



made in Italy



La tecnologia che semplifica
dal 1961

La serie di rubinetti da giardino fusi o in acciaio inox, vengono proposti cromati oppure in ottone sabbiato giallo. Alcuni modelli sono disponibili con o senza attacco porta gomma.

The series of garden taps, made of cast or stainless steel, are offered in chrome or yellow sandblasted brass. Some models are available with or without a hose union.

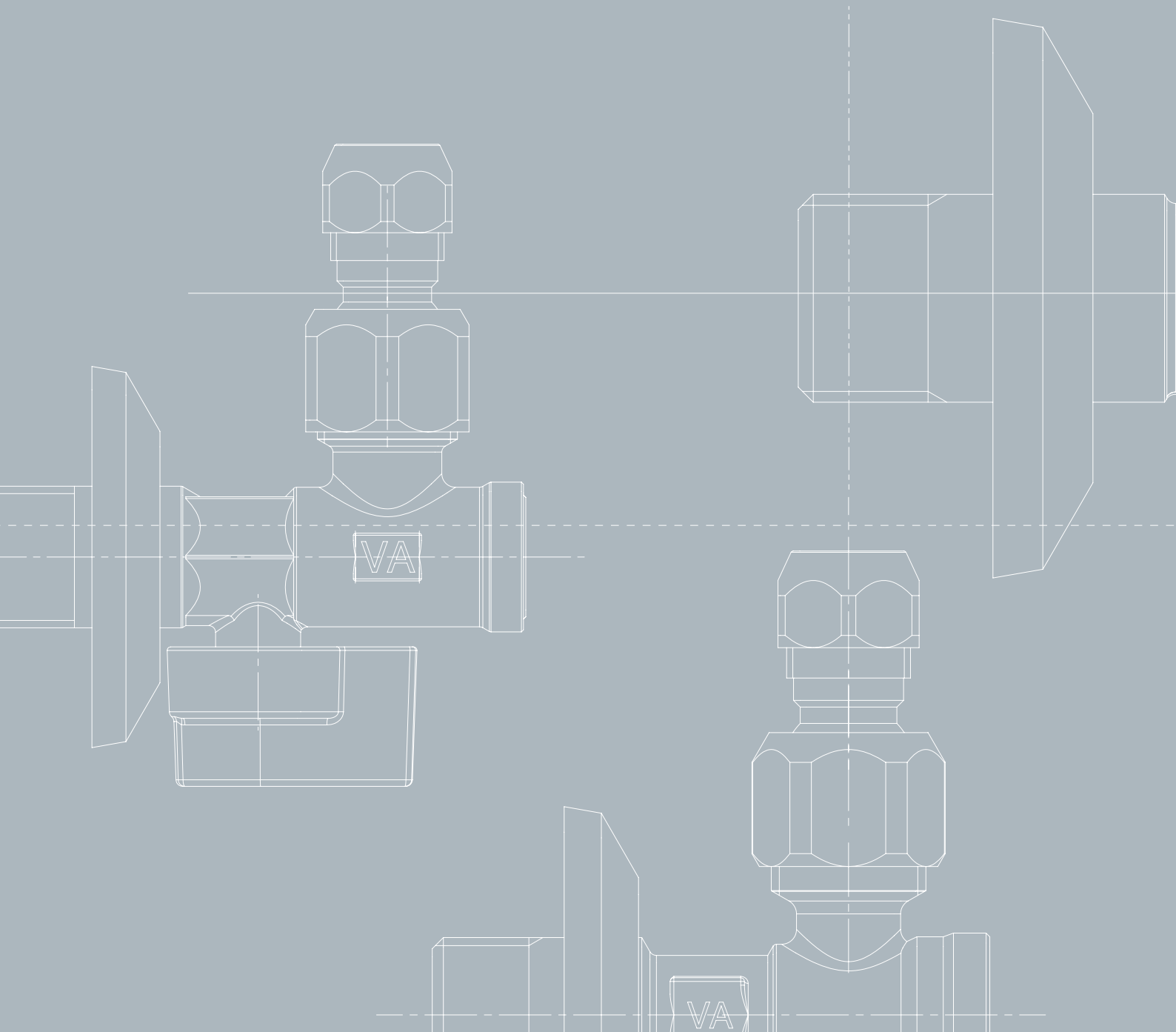

Rubinetti giardino

Garden taps

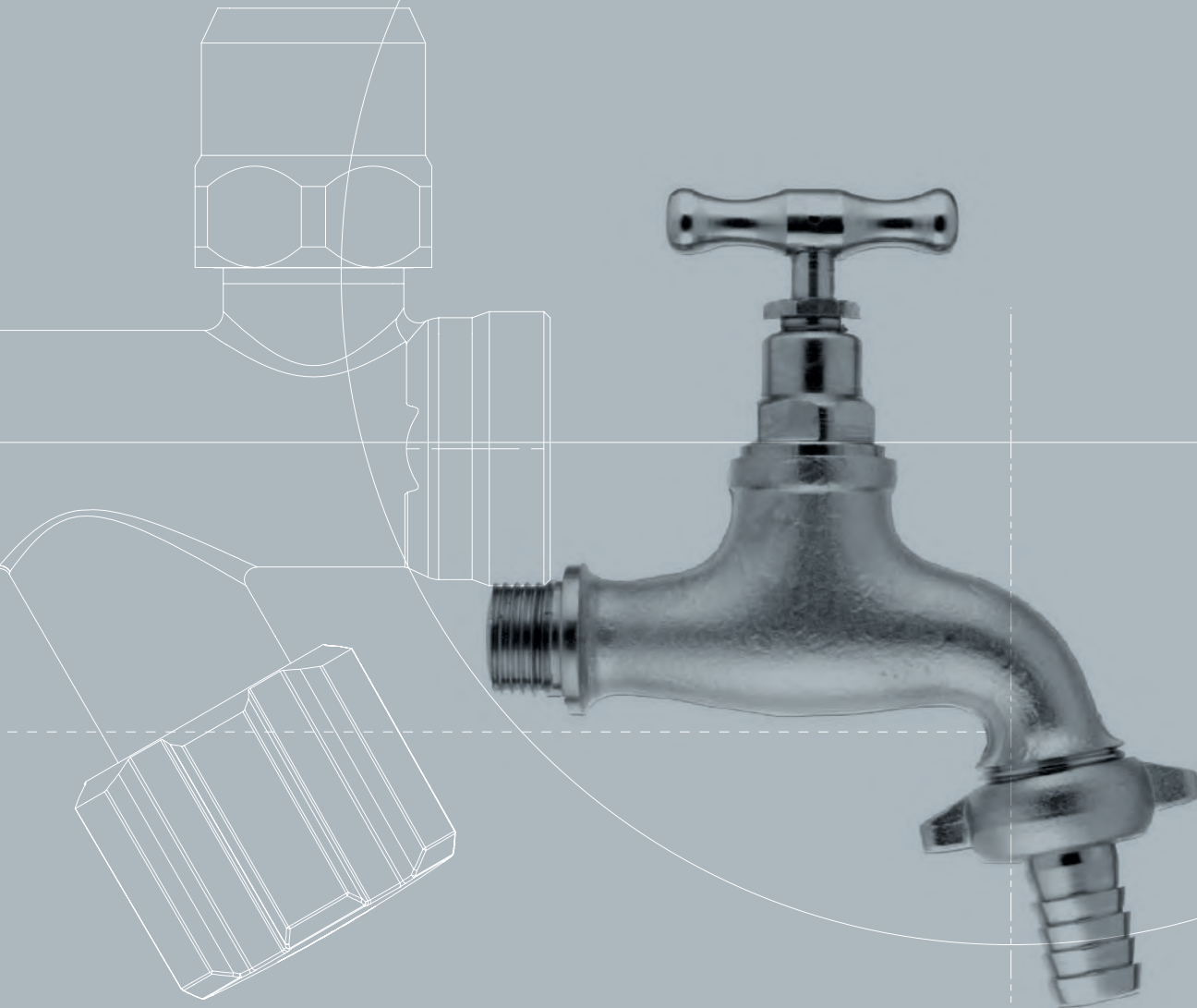

Rubinetti giardino / Garden taps



Rubinetti da giardino in ottone fuso, vitone con premistoppa, maniglia ottone, portagomma
Box 50 pz.

Garden tap in cast brass, brass spindle with stuffing box, brass handle, hose union
Box 50 pz.

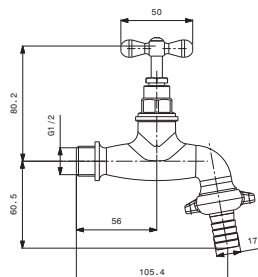

Cod.	Dim.	Kg/Pz.	Conf.	Pkg	Fin.	€
D1488901	M1/2" x M3/4"	0,48	1		gg s / br s	31,94
D1489901	M1/2" x M3/4"	0,48	1		cr s / chr s	35,07



Rubinetti da giardino in ottone fuso, vitone con premistoppa, maniglia a chiave levabile, portagomma
Box 50 pz.

Garden tap in cast brass, brass spindle with stuffing box, removable handle, hose union
Box 50 pz.

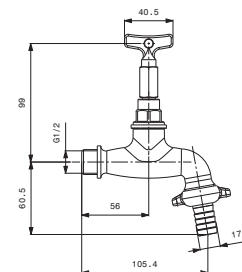

Cod.	Dim.	Kg/Pz.	Conf.	Pkg	Fin.	€
D1488903	M1/2" x M3/4"	0,48	1		gg s / br s	31,60
D1489903	M1/2" x M3/4"	0,48	1		cr s / chr s	33,29



Rubinetti da giardino in acciaio AISI304, vitone ceramico quarto di giro
Box 12 pz.

Garden tap stainless steel AISI304, ceramic cartridge quarter turn
Box 12 pz.

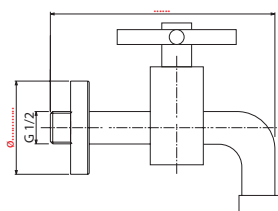

Cod.	Dim.	Kg/Pz.	Conf.	Pkg	Fin.	€
F1487000	M1/2"	0,50	1		inox / steel	81,22
F1488000	M1/2" x F3/4"	0,47	1		inox / steel	107,38

Rubinetti giardino / Garden taps

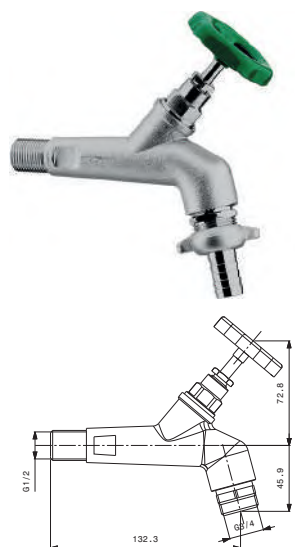

Rubinetto da giardino in ottone fuso con antiritorno, vitone con premistoppa, maniglia volante colorata, portagomma, cromato sabbiato
Box 30 pz.

Garden tap in cast brass with no back flow device, brass spindle with stuffing box, colored roundhandle, hose union, sandblasted chrome
Box 30 pz.



Cod.	Dim.	Kg/Pz.	Conf.	Pkg	Fin.	€
D1484001	M1/2" x M3/4"	0,69	1		cr s / chr s	51,76

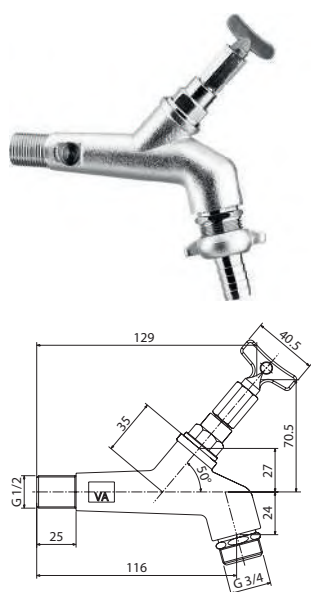

Rubinetto da giardino in ottone fuso con antiritorno, vitone con premistoppa, maniglia a chiave levabile, portagomma, cromato sabbiato
Box 30 pz.

Garden tap in cast brass with no back flow device, brass spindle with stuffing box, removable handle, hose union, sandblasted chrome
Box 30 pz.



Cod.	Dim.	Kg/Pz.	Conf.	Pkg	Fin.	€
D1484003	M1/2" x M3/4"	0,69	1		cr s / chr s	52,16



Rubinetto a fontana a pulsante, giallo
Box 25 pz.

Fountain tap self closing
Box 25 pz.

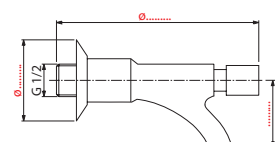

Cod.	Dim.	Kg/Pz.	Conf.	Pkg	Fin.	€
K07100	M1/2"	0,43	1		gg / br raw	63,12

Rubinetti giardino / Garden taps



Rubinetto da giardino
ECO, maniglia ABS
verde, cromo sabbato
Box 30 pz.

ECO garden faucet,
green ABS handle,
sandblasted chrome
Box 30 pz.

Cod.	Dim.	Kg/Pz.	Conf.	Pkg	Fin.	€
D1484801	M1/2" x M3/4"	0,69	1		cr s / chr s	12,12

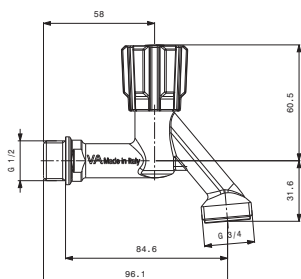

Rubinetto da giardino
ECO, maniglia
ABS verde, con
portagomma, cromo
sabbato
Box 30 pz.

ECO garden faucet,
green ABS handle,
sandblasted chrome
Box 30 pz.

Cod.	Dim.	Kg/Pz.	Conf.	Pkg	Fin.	€
D1484805	M1/2" x M3/4"	0,69	1		cr s / chr s	14,26

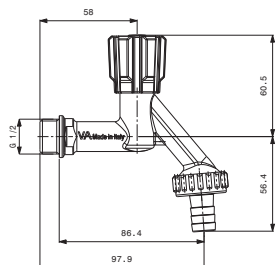

Rubinetto da giardino
ECO, maniglia ABS
verde, giallo sabbato
Box 30 pz.

ECO garden faucet,
green ABS handle,
sandblasted yellow
Box 30 pz.

Cod.	Dim.	Kg/Pz.	Conf.	Pkg	Fin.	€
D1483801	M1/2" x M3/4"	0,69	1		gg s / br s	12,21

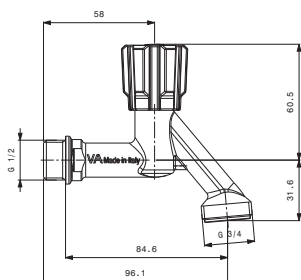

Rubinetti giardino / Garden taps



Vitone giardino con
volantino di ricambio
completo di vite
Box 100 pz.

Spindle for garden tap +
handle + screw
Box 100 pz.

Cod.	Dim.	Kg/Pz.	Conf.	Pkg	Fin.	€
R15420	1/2"	0,14	10		gg / br raw	15,50
R15425	1/2"	0,14	10		cr / chr	17,79



Vitone giardino
con chiave levabile
completo di vite
Box 100 pz.

Spindle for garden tap
+ screw
Box 100 pz.

Cod.	Dim.	Kg/Pz.	Conf.	Pkg	Fin.	€
R15430	1/2"	0,13	10		gg / br raw	15,06
R15435	1/2"	0,13	10		cr / chr	16,28



Chiave levabile per
rubinetti giardino
Box 100 pz.

Removable key for
garden tap
Box 100 pz.

Cod.	Dim.	Kg/Pz.	Conf.	Pkg	Fin.	€
R7810	Q6	0,03	10		gg / br raw	1,88
R7815	Q7	0,03	10		gg / br raw	1,97
R7800	Q6	0,02	10		nich / nik	1,88
R7805	Q7	0,03	10		nich / nik	2,01

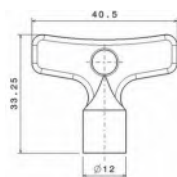

made in Italy



ALBERTONI

*La tecnologia che semplifica
dal 1961*

La serie di rubinetti ad angolo propone una vasta gamma di soluzioni per qualsiasi tipo di installazione: sottolavabo, per cassetta, per boilers. Ci sono poi rubinetti multifunzione, per diversi apparati insieme. Dovunque è richiesta una particolare attenzione al controllo e alla regolazione del flusso dell'acqua.

The angle valves series offers a wide range of solutions for any type of installation: under-sink, for cisterns, for boilers. There are also multifunction angle valves connecting various devices simultaneously. These angle valves are ideal wherever precise control and regulation of water flow are required.



Rubinetti sottolavabo

Angle valves

Rubinetti multiuso

Multipurpose angle valves

Rubinetti per cassetta

Angle valves for WC cistern

Rubinetti per scaldabagno

Angle valves for water heater

Valvole minisfera

Mini ball valves

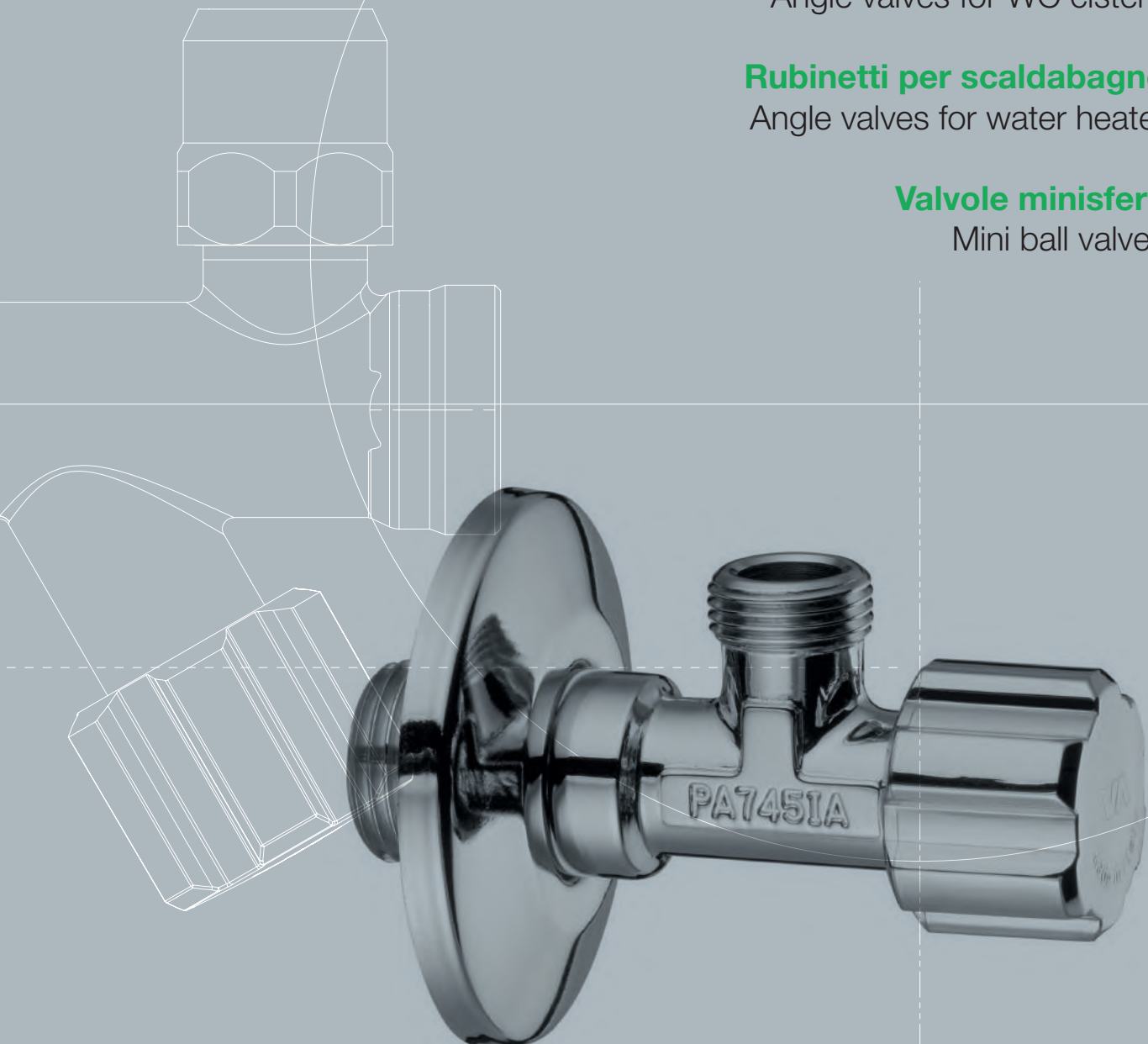

Rubinetti sottolavabo / Angle valves



Rubinetto sottolavabo ASE H45, vitone ottone, maniglia ABS, rosone inox, cromato
Box 100 pz.

Angle valve ASE H45, multitem brass spindle, ABS handle, inox cover plate, chrome-plated
Box 100 pz.

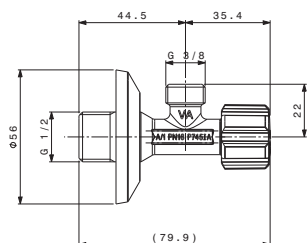

Cod.	Dim.	Kg/Pz.	Conf.	Pkg	Fin.	€
C426481	M1/2" x M3/8"	0,11	1		cr / chr	5,05
C428681	M1/2" x M1/2"	0,10	1		cr / chr	5,36



Rubinetto sottolavabo ASE H45, vitone ottone, maniglia ABS bianca, rosone inox, cromato
Box 100 pz.

Angle valve ASE H45, multitem brass spindle, ABS white handle, inox cover plate, chrome-plated
Box 100 pz.

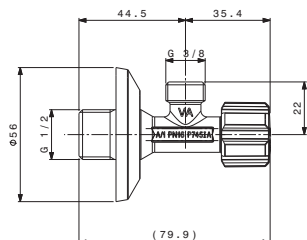

Cod.	Dim.	Kg/Pz.	Conf.	Pkg	Fin.	€
C426481WR	M1/2" x M1/2"	0,09	1		cr / chr	4,89
C428681WR	M1/2" x M3/8"	0,10	1		cr / chr	4,98



Rubinetto sottolavabo ASE H45, vitone ottone, maniglia triangolare ABS, rosone inox, cromato
Box 200 pz.

Angle valve ASE H45, multitem brass spindle, ABS triangular handle, inox cover plate, chrome plated
Box 200 pz.

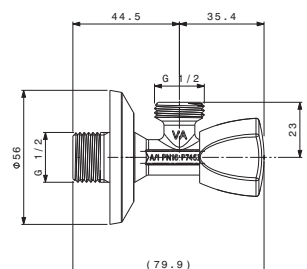

Cod.	Dim.	Kg/Pz.	Conf.	Pkg	Fin.	€
C426485	M1/2" x M3/8"	0,11	1		cr / chr	6,17
C428685	M1/2" x M1/2"	0,11	1		cr / chr	6,28

Rubinetti sottolavabo / Angle valves



Rubinetto sottolavabo STE H45, vitone ottone, maniglia ABS, rosone inox, cromato
Box 200 pz.

Angle valve STE H45, multium brass spindle, ABS handle, inox cover plate, chrome-plated
Box 200 pz.

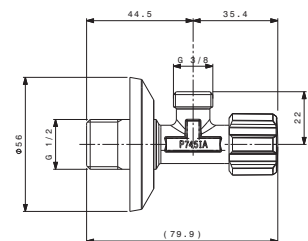

Cod.	Dim.	Kg/Pz.	Conf.	Pkg	Fin.	€
C406281SD	M1/2" x M3/8"	0,12	1		cr / chr	5,70
C408681	M1/2" x M1/2"	0,12	1		cr / chr	5,69



Rubinetto sottolavabo STE H45, vitone ottone, maniglia ABS, dado conico basso, rosone inox, cromato
Box 100 pz.

Angle valve STE H45, multium brass spindle, ABS handle, compression nut, inox cover plate, chrome-plated
Box 100 pz.

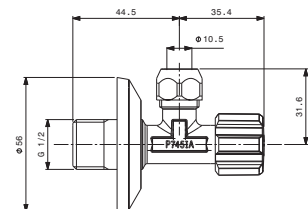

Cod.	Dim.	Kg/Pz.	Conf.	Pkg	Fin.	€
C446181	M3/8" x M3/8" x Ø10	0,12	1		cr / chr	7,23
C406281	M1/2" x M3/8" x Ø10	0,13	1		cr / chr	6,56



Rubinetto sottolavabo STE H45, vitone ottone, maniglia ABS, dado conico alto, rosone inox, cromato
Box 100 pz.

Angle valve STE H45, multium brass spindle, ABS handle, compression nut, inox cover plate, chrome-plated
Box 100 pz.

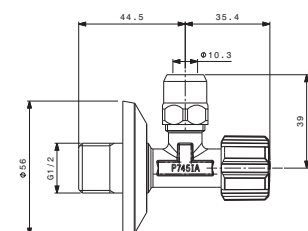

Cod.	Dim.	Kg/Pz.	Conf.	Pkg	Fin.	€
C447581	M3/8" x M3/8" x Ø10	0,13	1		cr / chr	7,92
C407681	M1/2" x M3/8" x Ø10	0,13	1		cr / chr	6,81

Rubinetti sottolavabo / Angle valves



Rubinetto sottolavabo,
vitone ottone, maniglia
ottone, dado conico
alto, rosone inox,
cromato
Box 100 pz.

Angle valve, multium
brass spindle, brass
handle, compression
nut, inox cover plate,
chrome plated
Box 100 pz.

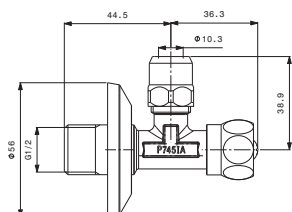

Cod.	Dim.	Kg/Pz.	Conf.	Pkg	Fin.	€
C446680	M1/2" x M3/8" x Ø10	0,16	1		cr / chr	10,86



Rubinetto sottolavabo,
vitone ottone, maniglia
ottone BIRILLO, dado
conico alto, rosone
inox, cromato
Box 50 pz.

Angle valve, multium
brass spindle, brass
handle BIRILLO,
compression nut, inox
cover plate, chrome
plated
Box 50 pz.

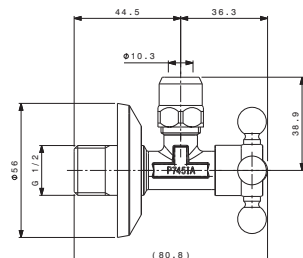

Cod.	Dim.	Kg/Pz.	Conf.	Pkg	Fin.	€
C446692	M1/2" x M3/8" x Ø10	0,20	1		cr / chr	18,20



Rubinetto sottolavabo,
vitone ottone,
cappuccio chiuso,
dado conico alto,
rosone inox, cromato
Box 100 pz.

Angle valve, multium
brass spindle, close
brass cap, compression
nut, inox cover plate,
chrome plated
Box 100 pz.

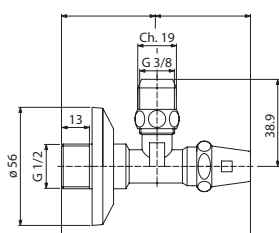

Cod.	Dim.	Kg/Pz.	Conf.	Pkg	Fin.	€
C446682	M1/2" x M3/8" x Ø10	0,15	1		cr / chr	11,28

Rubinetti sottolavabo / Angle valves



Rubinetto sottolavabo STE H45, vitone ottone, maniglia ABS, dado conico alto, rosone inox, anello di tenuta PTFE, cromato
Box 100 pz.

Cod.	Dim.	Kg/Pz.	Conf.	Pkg	Fin.	€
C447781	M3/8" x M3/8" x Ø10	0,13	1		cr / chr	8,15
C407881	M1/2" x M3/8" x Ø10	0,14	1		cr / chr	7,37

Angle valve STE H45, multitem brass spindle, ABS handle, compression nut, inox cover plate, sealing PTFE ring, chrome-plated
Box 100 pz.

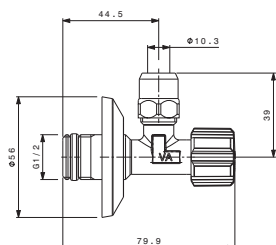

Rubinetto sottolavabo STE H45, vitone HS, maniglia ABS, dado conico basso, rosone inox, cromato
Box 200 pz.

Cod.	Dim.	Kg/Pz.	Conf.	Pkg	Fin.	€
C402281	M1/2" x M3/8" x Ø10	0,13	1		cr / chr	6,37

Angle valve STE H45, HS multitem spindle, ABS handle, compression nut, inox cover plate, chrome-plated
Box 200 pz.

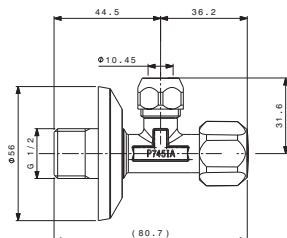

Rubinetto sottolavabo, maniglia ABS, rosone inox Ø76, interasse 84mm tutto filetto, cromato
Box 100 pz.

Cod.	Dim.	Kg/Pz.	Conf.	Pkg	Fin.	€
C846294	M1/2" x M3/8" x Ø10	0,18	1		cr / chr	15,57

H84 angle valve, brass spindle, ABS handle, high conical nut, stainless rosette D.76, chrome plated
Box 100 pz.

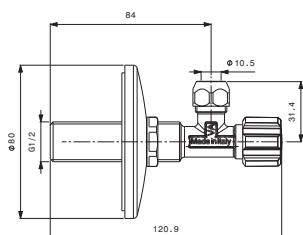

Rubinetti sottolavabo / Angle valves

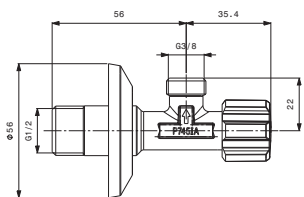

Rubinetto sottolavabo STE H56, vitone ottone, maniglia ABS, senza dado, rosone inox, cromato
Box 100 pz.

Angle valve STE H56, multium brass spindle, ABS handle, without nut, inox cover plate, chrome plated
Box 100 pz.

Cod.	Dim.	Kg/Pz.	Conf.	Pkg	Fin.	€
C566281SDSAC	M1/2" x M3/8"	0,12	1		cr / chr	6,62
C568681	M1/2" x M1/2"	0,12	1		cr / chr	7,57

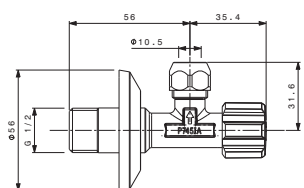

Rubinetto sottolavabo STE H56, vitone ottone, maniglia ABS, dado conico basso, rosone inox, cromato
Box 100 pz.

Angle valve STE H56, multium brass spindle, ABS handle, compression nut, inox cover plate, chrome plated
Box 100 pz.

Cod.	Dim.	Kg/Pz.	Conf.	Pkg	Fin.	€
C566281	M1/2" x M3/8" x Ø10	0,14	1		cr / chr	8,28

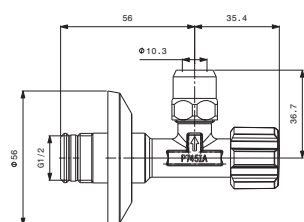

Rubinetto sottolavabo STE H56, vitone ottone, maniglia ABS, dado conico alto, rosone inox, anello di tenuta PTFE, cromato
Box 100 pz.

Angle valve STE H56, multium brass spindle, ABS handle, compression nut, inox cover plate, PTFE sealing ring, chrome-plated
Box 100 pz.



Cod.	Dim.	Kg/Pz.	Conf.	Pkg	Fin.	€
C567894	M1/2" x M3/8" x Ø10	0,15	1		cr / chr	9,81

Rubinetti sottolavabo / Angle valves



Rubinetto sottolavabo STE H65, vitone ottone, maniglia ABS, rosone inox, cromato
Box 100 pz.

Angle valve STE H56, multitem brass spindle, ABS handle, inox cover plate, chrome plated
Box 100 pz.

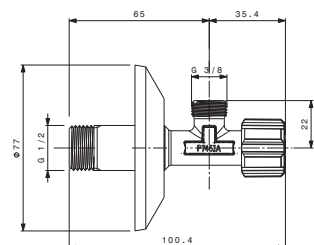

Cod.	Dim.	Kg/Pz.	Conf.	Pkg	Fin.	€
C657694SD	M1/2" x M3/8"	0,15	2		cr / chr	8,77
C658694	M1/2" x M1/2"	0,17	1		cr / chr	9,34



Rubinetto sottolavabo STE H65, vitone ottone, maniglia ABS, dado conico alto, rosone inox, cromato
Box 100 pz.

Angle valve STE H56, multitem brass spindle, ABS handle, compression nut, inox cover plate, chrome plated
Box 100 pz.

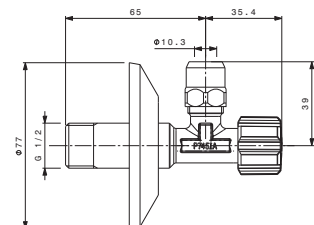

Cod.	Dim.	Kg/Pz.	Conf.	Pkg	Fin.	€
C657694	M1/2" x M3/8" x Ø10	0,17	2		cr / chr	10,30



Rubinetto sottolavabo INOX 316L H65mm, vitone CW724R, maniglia PA66, rosone inox Ø 77mm, cromato
Box 10 pz.

Angle valve INOX 316L H65 mm, multitem spindle CW724R, PA66 handle, inox cover plate Ø 77mm, chrome plated
Box 10 pz.

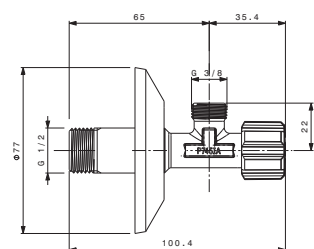

Cod.	Dim.	Kg/Pz.	Conf.	Pkg	Fin.	€
F656494	M1/2" x M3/8"	0,15	1		cr / chr	30,00

Rubinetti sottolavabo / Angle valves

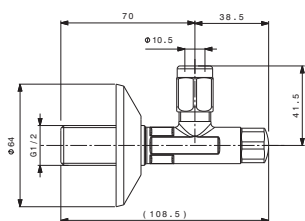

Rubinetto sottolavabo pesante 70 mm, vitone ottone, cappuccio ottone chiuso, dado conico alto, rosone inox, cromato
Box 50 pz.

Heavy angle valve 70 mm, multiturn brass spindle, closed brass cap, compression nut, inox cover plate, chrome plated
Box 50 pz.

Cod.	Dim.	Kg/Pz.	Conf.	Pkg	Fin.	€
E230168	M3/8" x M3/8" x Ø10	0,19	1		cr / chr	18,16
E330462	M1/2" x M3/8" x Ø10	0,22	1		cr / chr	14,32

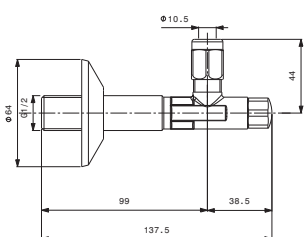

Rubinetto sottolavabo pesante 100 mm, vitone ottone, cappuccio ottone chiuso, dado conico alto, rosone inox, cromato
Box 50 pz.

Heavy angle valve 100 mm, multiturn brass spindle, closed brass cap, compression nut, inox cover plate, chrome plated
Box 50 pz.

Cod.	Dim.	Kg/Pz.	Conf.	Pkg	Fin.	€
E230263	M3/8" x M3/8" x Ø10	0,23	1		cr / chr	19,94
E330562	M1/2" x M3/8" x Ø10	0,27	1		cr / chr	17,60

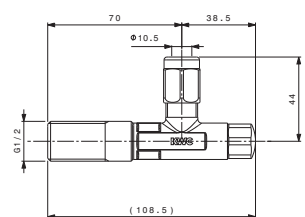

Rubinetto sottolavabo pesante 70 mm, vitone ottone, cappuccio ottone chiuso, dado conico alto, giallo sabbato
Box 50 pz.

Heavy angle valve 70 mm, multiturn brass spindle, closed brass cap, compression nut, inox cover plate, sandblasted brass
Box 50 pz.

Cod.	Dim.	Kg/Pz.	Conf.	Pkg	Fin.	€
E330862	M1/2" x M3/8" x Ø10	0,20	1		gg s / br s	11,31

Rubinetti sottolavabo / Angle valves



Raccordo retrogruppo
con arresto
Box 50 pz.

Stop valve for wall
mounting
Box 50 pz.

Cod.	Dim.	Kg/Pz.	Conf.	Pkg	Fin.	€
K07041	M1/2" x F1/2"	0,22	1		cr / chr	33,88

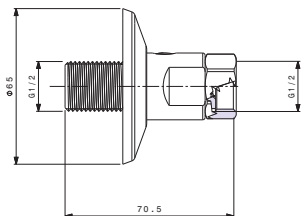

Raccordo retrogruppo
eccentrico 5 mm con
arresto
Box 50 pz.

Stop valve for wall
mounting 5 mm
eccentric
Box 50 pz.

Cod.	Dim.	Kg/Pz.	Conf.	Pkg	Fin.	€
K07032	M1/2" x M3/4"	0,23	1		cr / chr	44,59

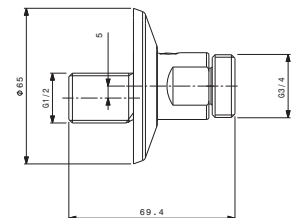

Raccordo retrogruppo
con arresto
Box 50 pz.

Stop valve for wall
mounting
Box 50 pz.

Cod.	Dim.	Kg/Pz.	Conf.	Pkg	Fin.	€
K07042	M1/2" x F3/4"	0,25	1		cr / chr	33,93

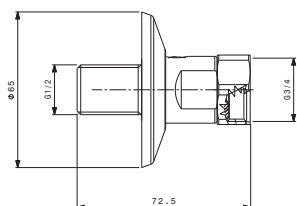

Rubinetti sottolavabo / Angle valves



Rubinetto sottolavabo H48, vitone ottone, maniglia triangolare zama, rosone inox, cromato
Box 50 pz.

Angle valve H48, multitem brass spindle, triangular zamak handle, inox cover plate, chrome plated
Box 50 pz.

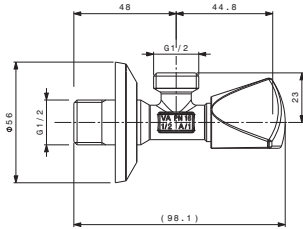

Cod.	Dim.	Kg/Pz.	Conf.	Pkg	Fin.	€
C148486	M1/2" x M3/8"	0,20	1		cr / chr	9,83
C147486	M1/2" x M1/2"	0,20	1		cr / chr	9,58



Rubinetto sottolavabo H45, vitone ottone, maniglia ARBA zama, rosone inox, cromato
Box 100 pz.

Angle valve H45, multitem brass spindle, zamak ARBA handle, inox cover plate, chrome plated
Box 100 pz.

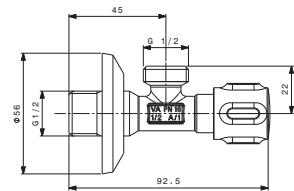

Cod.	Dim.	Kg/Pz.	Conf.	Pkg	Fin.	€
C156484	M1/2" x M3/8"	0,16	1		cr / chr	9,15
C158684	M1/2" x M1/2"	0,16	1		cr / chr	9,27



Rubinetto sottolavabo H48, vitone ottone, maniglia esagonale ABS, rosone inox, cromato
Box 100 pz.

H48 angle valve, brass spindle, triangular ABS handle, stainless steel rosette, chrome-plated
Box 100 pz.

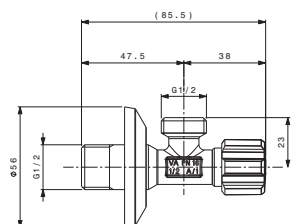

Cod.	Dim.	Kg/Pz.	Conf.	Pkg	Fin.	€
C498694	M1/2" x M1/2"	0,14	1		cr / chr	7,42

Rubinetti multiuso / Multipurpose angle valves



Rubinetto sottolavabo H32, vitone ottone, asta fissa, maniglia triangolare zama con placchetta, cromato
Box 200 pz.

Angle valve H32, non rising brass spindle, triangular zamak handle with indicy, chrome plated
Box 200 pz.

Cod.	Dim.	Kg/Pz.	Conf.	Pkg	Fin.	€
D105686	M1/2" x M1/2"	0,20	1		cr / chr	9,62

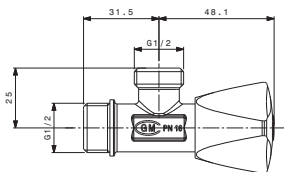

Rubinetto a croce, vitone ottone, maniglia ABS, rosone inox, cromato
Box 100 pz.

Cross angle valve, multitem brass spindle, ABS handle, inox cover plate, chrome plated
Box 100 pz.

Cod.	Dim.	Kg/Pz.	Conf.	Pkg	Fin.	€
D446694	M1/2" x M1/2" x 1/2"	0,16	1		cr / chr	8,62

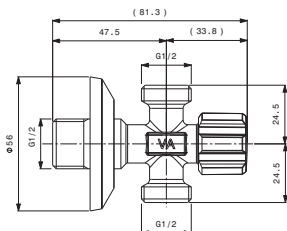

Rubinetto a croce, vitone ottone, maniglia zama, rosone inox, cromato
Box 50 pz.

Cross angle valve, multitem brass spindle, ZAMAK handle, inox cover plate, chrome plated
Box 50 pz.

Cod.	Dim.	Kg/Pz.	Conf.	Pkg	Fin.	€
D446696	M1/2" x M1/2" x 1/2"	0,23	1		cr / chr	11,52

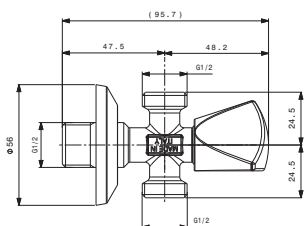

Rubinetti multiuso / Multipurpose angle valves



Rubinetto dual pesante, vitoni ottone, maniglie ABS, rosone inox, cromato
Box 50 pz.

Dual heavy angle valve, multium brass spindles, ABS handles, inox cover plate, chrome plated
Box 50 pz.

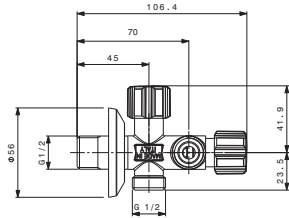

Cod.	Dim.	Kg/Pz.	Conf.	Pkg	Fin.	€
D448494	M1/2" x M3/8" x 3/8"	0,28	1		cr / chr	16,27
D448894	M1/2" x M1/2" x 1/2"	0,28	1		cr / chr	15,27
D447694	M1/2" x M3/8" x 3/8" con dado alto M1/2" x M3/8" x 3/8" with high nut	0,29	1		cr / chr	17,92



Rubinetto dual leggero, vitoni ottone, maniglie ABS, rosone inox, cromato
Box 50 pz.

Dual lightangle valve, multium brass spindles, ABS handles, inox cover plate, chrome plated
Box 50 pz.

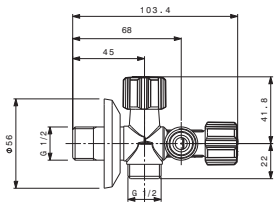

Cod.	Dim.	Kg/Pz.	Conf.	Pkg	Fin.	€
D445694	M1/2" x M1/2" x 1/2"	0,24	1		cr / chr	13,09



Rubinetto dual leggero, vitoni ottone, maniglie ABS bianche, rosone inox, cromato
Box 50 pz.

Dual lightangle valve, multium brass spindles, ABS white handles, inox cover plate, chrome plated
Box 50 pz.

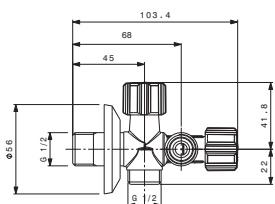

Cod.	Dim.	Kg/Pz.	Conf.	Pkg	Fin.	€
D445694WR	M1/2" x M1/2" x 1/2"	0,24	1		cr / chr	12,83

Rubinetti multiuso / Multipurpose angle valves



Rubinetto dual pesante, vitoni ottone, maniglie ZAMA, rosone inox, cromato
Box 50 pz.

Dual heavy angle valve, multium brass spindle, ABS handle, chrome plated
Box 50 pz.

Cod.	Dim.	Kg/Pz.	Conf.	Pkg	Fin.	€
D448686	M1/2" x M1/2" x M1/2"	0,39	1	 cr / chr	21,94	

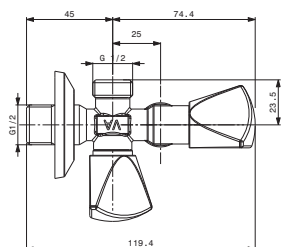

Rubinetti multiuso / Multipurpose angle valves



Rubinetto a V, vitone ottone, maniglia ABS, rosone inox, cromato
Box 50 pz.

V shaped angle valve, multium brass spindle, ABS handle, inox cover plate, chrome plated
Box 50 pz.

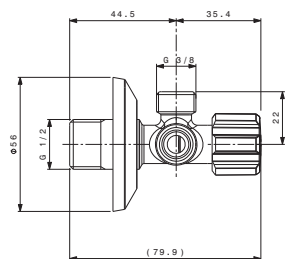

Cod.	Dim.	Kg/Pz.	Conf.	Pkg	Fin.	€
D441094	M1/2" x M3/8" x M3/8"	0,12	1		cr / chr	7,10
D441294	M1/2" x M9/16" x 9/16"	0,12	1		cr / chr	7,29



Rubinetto a V femmina, vitone ottone, maniglia ABS, cromato
Box 100 pz.

V shaped valve female, multium brass spindle, ABS handle, chrome plated
Box 100 pz.

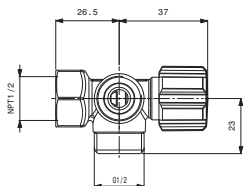

Cod.	Dim.	Kg/Pz.	Conf.	Pkg	Fin.	€
D101481	F1/2" NPT x M9/16"	0,11	1		cr / chr	7,58
D101581	F1/2" NPT x M1/2"	0,13	1		cr / chr	8,08



Rubinetto diritto femmina, vitone ottone, maniglia ABS, cromato
Box 100 pz.

Straight valve female, multium brass spindle, ABS handle, chrome plated
Box 100 pz.

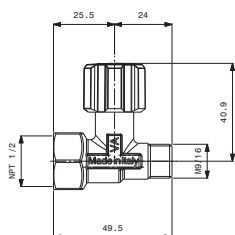

Cod.	Dim.	Kg/Pz.	Conf.	Pkg	Fin.	€
D101081	F1/2" NPT x M9/16"	0,12	1		cr / chr	5,85
D101181	F1/2" NPT x M1/2"	0,10	1		cr / chr	6,15

Rubinetti per cassetta / Angle valves for WC cistern



Rubinetto ad angolo femmina, vitone ottone, maniglia ABS, cromato
Box 100 pz.

Angle valve female, multitem brass spindle, ABS handle, chrome plated
Box 100 pz.

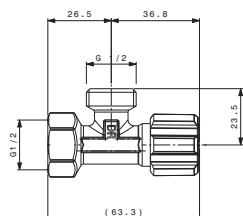

Cod.	Dim.	Kg/Pz.	Conf.	Pkg	Fin.	€
D100281SD	F1/2" x M3/8"	0,08	1		cr / chr	5,22
D100181SD	F1/2" x M1/2"	0,10	1		cr / chr	5,73
D100481	F1/2" NPT x M9/16"	0,08	1		cr / chr	5,30
D100581	F1/2" NPT x M1/2"	0,10	1		cr / chr	5,53



Rubinetto ad angolo femmina, vitone ottone, maniglia ABS, dado conico basso, cromato
Box 100 pz.

Angle valve female, multitem brass spindle, ABS handle, compression nut, chrome plated
Box 100 pz.

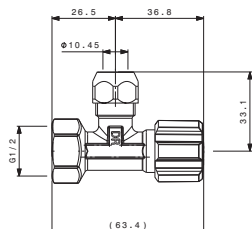

Cod.	Dim.	Kg/Pz.	Conf.	Pkg	Fin.	€
D100181	F1/2" x M1/2"	0,12	1		cr / chr	8,11
D100281	F1/2" x M3/8"	0,11	1		cr / chr	6,62



Rubinetto ad angolo femmina entrata con ogiva, vitone ottone, maniglia ABS, dado girevole 3/8, cromato
Box 100 pz.

Angle valve female inlet with brass sleeve, multitem brass spindle, ABS handle, swivelling nut 3/8, chrome plated
Box 100 pz.

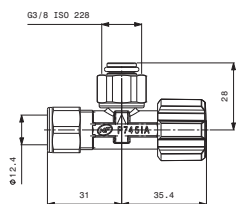

Cod.	Dim.	Kg/Pz.	Conf.	Pkg	Fin.	€
D102281	entrata ogiva F3/8" x Ø12 Inlet F3/8" x Ø12	0,09	1		cr / chr	7,14
D102481	entrata ogiva F1/2" x Ø15 Inlet F1/2" x Ø15	0,11	1		cr / chr	8,92

Rubinetti per cassetta / Angle valves for WC cistern



Rubinetto maschio,
vitone ottone, maniglia
ABS
Box 100 pz.

Male angle valve,
multitum brass spindle,
ABS handle, chrome
plated
Box 100 pz.

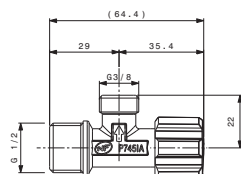

Cod.	Dim.	Kg/Pz.	Conf.	Pkg	Fin.	€
D103681	M1/2" x M3/8"	0,08	1		cr / chr	4,85
D103481SD	M3/8" x M3/8"	0,09	1		cr / chr	6,20



Rubinetto maschio,
vitone ottone, maniglia
ABS, giallo grezzo
Box 200 pz.

Male angle valve,
multitum brass spindle,
ABS handle, raw brass
Box 200 pz.

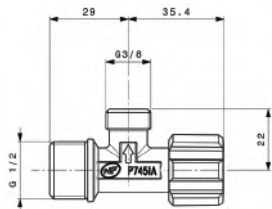

Cod.	Dim.	Kg/Pz.	Conf.	Pkg	Fin.	€
AGG103684	M1/2" x M3/8"	0,08	1		gg / br raw	3,63

Rubinetti per cassetta / Angle valves for WC cistern



Rubinetto maschio,
vitone ottone, maniglia
ABS, anello di tenuta
in PTFE, dado conico
basso, cromato
Box 100 pz.

Male angle valve,
multitum brass
spindle, ABS handle,
PTFE sealing ring,
compression nut,
chrome plated
Box 100 pz.

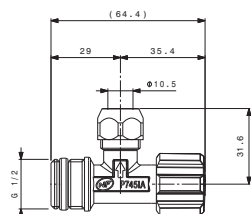

Cod.	Dim.	Kg/Pz.	Conf.	Pkg	Fin.	€
D106581	M1/2" x M3/8"	0,10	1		cr / chr	6,58



Rubinetto maschio,
vitone ottone, maniglia
ABS, anello di tenuta
in PTFE, giallo grezzo
Box 200 pz.

Male angle valve,
multitum brass spindle,
ABS handle, PTFE
sealing ring, raw brass
Box 200 pz.

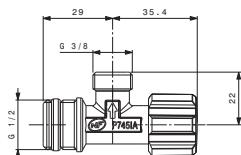

Cod.	Dim.	Kg/Pz.	Conf.	Pkg	Fin.	€
AGG106384SD	M1/2" x M3/8"	0,08	1		gg / br raw	4,49

Rubinetti per cassetta / Angle valves for WC cistern



Rubinetto maschio, vitone ottone, maniglia ABS, dado conico basso, cromato
Box 100 pz.

Male angle valve, multitem brass spindle, ABS handle, compression nut, chrome plated
Box 100 pz.

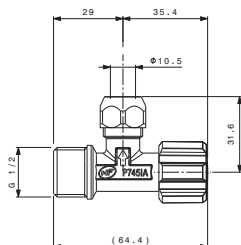

Cod.	Dim.	Kg/Pz.	Conf.	Pkg	Fin.	€
D104081	M3/8" x M3/8"	0,10	1		cr / chr	6,83
D104181	M1/2" x M3/8"	0,09	1		cr / chr	5,92



Rubinetto per cassetta maschio H29 mm, vitone ottone, maniglia ABS, codolo filettato 12/19 e dado, cromato
Box 100 pz.

Angle valve for WC cistern male H29 mm, multitem brass spindle, ABS handle, threaded tailpiece 12/19 and nut, chrome plated
Box 100 pz.

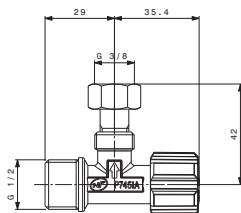

Cod.	Dim.	Kg/Pz.	Conf.	Pkg	Fin.	€
D110481	M3/8"-F12/19 x M3/8"-F3/8"	0,11	1		cr / chr	7,51
D110581	M1/2"-F12/19 x M3/8"-F3/8"	0,10	1		cr / chr	6,84



Rubinetto maschio, vitone ottone, maniglia ABS, dado conico alto, cromato
Box 100 pz.

Male angle valve, brass spindle, ABS handle, PTFE sealing ring, raw yellow
Box 100 pz.

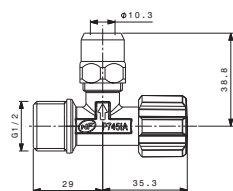

Cod.	Dim.	Kg/Pz.	Conf.	Pkg	Fin.	€
D106181	M1/2" x M3/8"	0,10	1		cr / chr	6,72

Rubinetti per cassetta / Angle valves for WC cistern



Rubinetto dritto femmina, vitone ottone, maniglia ABS, dado conico basso, cromato
Box 100 pz.

Straight valve female, multitem brass spindle, ABS handle, compression nut, chrome plated
Box 100 pz.

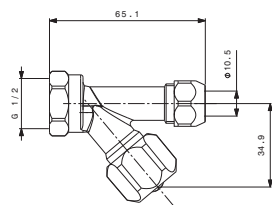

Cod.	Dim.	Kg/Pz.	Conf.	Pkg	Fin.	€
D433081	F1/2" Ø15 x M3/8" Ø10	0,11	1		cr / chr	7,66



Rubinetto dritto maschio, vitone ottone, maniglia ABS, dado conico basso, cromato
Box 100 pz.

Straight valve male, multitem brass spindle, ABS handle, compression nut, chrome plated
Box 100 pz.

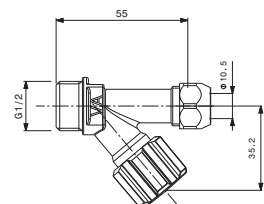

Cod.	Dim.	Kg/Pz.	Conf.	Pkg	Fin.	€
D436281	M1/2" x M3/8" x Ø10	0,11	1		cr / chr	8,01



Rubinetto dritto entrata con ogiva femmina 1/2 Ø 15 mm, vitone ottone, maniglia ABS, dado conico basso, cromato
Box 100 pz.

Straight valve inlet female with brass sleeve 1/2 Ø 15 mm, multitem brass spindle, ABS handle, compression nut, chrome plated
Box 100 pz.

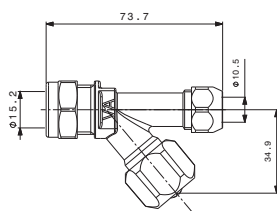

Cod.	Dim.	Kg/Pz.	Conf.	Pkg	Fin.	€
D431981	F1/2" Ø15 x M3/8" Ø10	0,13	1		cr / chr	10,58

Rubinetti per cassetta / Angle valves for WC cistern



Rubinetto per cassetta H45 mm, vitone ottone, maniglia ABS, codolo filettato 12/19 e dado, rosone inox, cromato
Box 100 pz.

Angle valve for WC cistern H45 mm, multium brass spindle, ABS handle, threaded tailpiece 12/19 and nut, chrome plated
Box 100 pz.

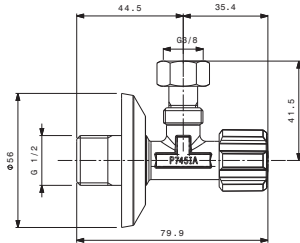

Cod.	Dim.	Kg/Pz.	Conf.	Pkg	Fin.	€
D149481	M1/2"-F12/19 x M3/8"-F3/8"	0,13	1		cr / chr	7,55



Rubinetto per cassetta, vitone ottone, maniglia ABS, 2 dadi conici bassi, tubetto Ø10x120mm, rosone inox, cromato
Box 50 pz.

Angle valve for WC cistern, multium brass spindle, ABS handle, 2 compression nuts, Ø10x120mm copper tube, cover plate inox, chrome plated
Box 50 pz.

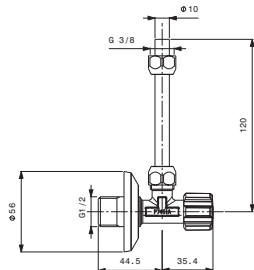

Cod.	Dim.	Kg/Pz.	Conf.	Pkg	Fin.	€
D149581	M3/8" x M3/8" x Ø10	0,15	1		cr / chr	9,07
D149681	M1/2" x M3/8" x Ø10	0,16	1		cr / chr	8,84



Rubinetto per cassetta, vitone ottone, maniglia ABS, 2 dadi conici bassi, tubetto Ø10x120mm, rosone inox, cromato
Box 100 pz.

Angle valve for WC cistern, multium brass spindle, ABS handle, 2 compression nuts, Ø10x120mm copper tube, cover plate inox, chrome plated
Box 100 pz.

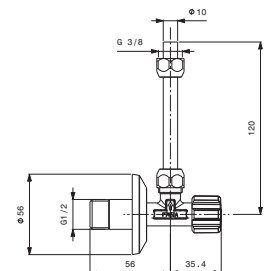

Cod.	Dim.	Kg/Pz.	Conf.	Pkg	Fin.	€
D569694	M1/2" x M3/8" x Ø10	0,17	1		cr / chr	10,11

Rubinetti per cassetta / Angle valves for WC cistern



Rubinetto per cassetta femmina, vitone ottone, maniglia ABS, codolo filettato 12/19 e dado, cromato
Box 100 pz.

Angle valve for WC cistern female, multitem brass valve, ABS handle, threaded tailpiece 12/19 and nut, chrome plated
Box 100 pz.

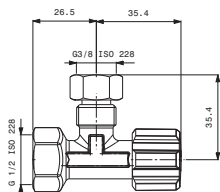

Cod.	Dim.	Kg/Pz.	Conf.	Pkg	Fin.	€
D113381	F3/8" x M3/8"	0,09	1		cr / chr	5,68
D113581	F1/2" x M3/8"	0,10	1		cr / chr	7,10



Rubinetto per cassetta femmina con prolunga rame e nipples giallo, vitone ottone, maniglia ABS, codolo filettato 12/19, rosone, cromato
Box 100 pz.

Angle valve for WC cistern female with copper tube extension and raw nipple, multitem brass valve, ABS handle, threaded tailpiece 12/19, cover plate, chrome plated
Box 100 pz.

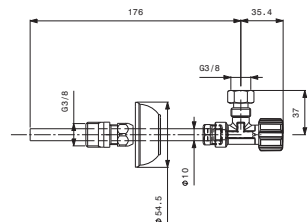

Cod.	Dim.	Kg/Pz.	Conf.	Pkg	Fin.	€
D149281	M3/8"-F12/19 x M3/8"-F3/8"	0,19	1		cr / chr	15,00
D149181	M1/2"-F12/19 x M3/8"-F3/8"	0,19	1		cr / chr	16,06



Rubinetto per cassetta femmina con prolunga rame e nipples giallo, vitone ottone, maniglia ABS, 2 dadi conici bassi, tubetto Ø10x120 mm, rosone, cromato
Box 50 pz.

Angle valve for WC cistern female with copper tube extension and raw nipple, multitem brass spindle, ABS handle, 2 compression nut and Ø10x120 mm copper tube, cover plate, chrome plated
Box 50 pz.

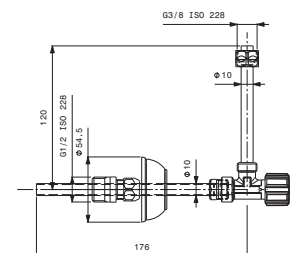

Cod.	Dim.	Kg/Pz.	Conf.	Pkg	Fin.	€
D145881	M3/8"-F12/19 x M3/8"-F3/8" con premistoppa	0,21	1		cr / chr	17,94
D145781	M3/8"-F12/19 x M3/8"-F3/8" with stuffing box					
D145781	M1/2"-F12/19 x M3/8"-F3/8"	0,22	1		cr / chr	15,54
D145781ST	M1/2"-F12/19 x M3/8"-F3/8" con premistoppa	0,22	1		cr / chr	18,00
	M1/2"-F12/19 x M3/8"-F3/8" with stuffing box					

Rubinetti per scaldabagno / Angle valves for water heater



Kit completo per scaldabagno con prolunga rame e nipples giallo, vitone ottone, maniglia triangolare zama, codolo filettato 12/19, 2 dadi conici bassi, tubetto Ø10x120 mm, rosone, raccordo MF1/2, cromato
Box 25 pz.

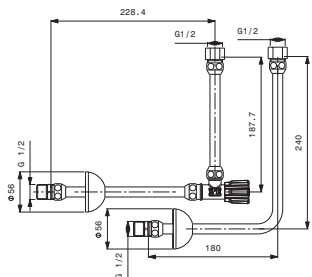

Complete set for water heater, with copper tube extension and raw nipple, multitem brass spindle, ZAMAK triangular handle, threaded tailpiece 12/19, 2 compression nut and Ø10x120 mm copper tube, cover plate, connection MF1/2, chrome plated
Box 25 pz.

Cod.	Dim.	Kg/Pz.	Conf.	Pkg	Fin.	€
D150081	M1/2" x F1/2"	0,62	1		cr / chr	44,03



Rubinetto per scaldabagno, vitone ottone, maniglia triangolare ABS, 2 dadi conici bassi, cromato
Box 50 pz.

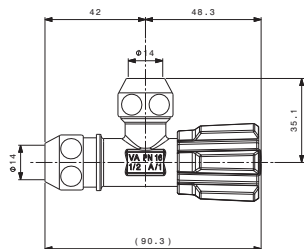

Angle valve for water heater, multitem brass spindle, ABS triangular handle, 2 compression nuts, chrome plated
Box 50 pz.

Cod.	Dim.	Kg/Pz.	Conf.	Pkg	Fin.	€
D132081	M1/2" Ø14 x M1/2" Ø14	0,17	1		cr / chr	12,16



Rubinetto arresto per scaldabagno, vitone ottone, maniglia ottone, cromato
Box 50 pz.

Stop valve for water heater, multitem brass valve, brass handle, chrome plated
Box 50 pz.

Cod.	Dim.	Kg/Pz.	Conf.	Pkg	Fin.	€
D157187	F1/2" x F1/2"	0,30	1		cr / chr	32,49
D158187	M1/2" x F1/2"	0,30	1		cr / chr	32,49

Rubinetti per scaldabagno / Angle valves for water heater



Curva 90° MF dado
girevole, cromata
Box 100 pz.

Elbow 90° male-female
with swivel nut, chrome
plated
Box 100 pz.

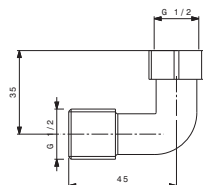

Cod.	Dim.	Kg/Pz.	Conf.	Pkg	Fin.	€
G02866	M1/2" x F1/2"	0,09	10		cr / chr	8,83
G02867	M1/2" x F3/4"	0,10	10		cr / chr	7,90

Raccordo diritto MF
con dado girevole,
cromato
Box 100 pz.



Straight nipple male-
female with swivel nut,
chrome plated
Box 100 pz.

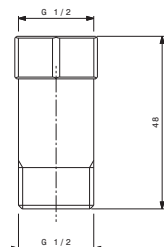

Cod.	Dim.	Kg/Pz.	Conf.	Pkg	Fin.	€
G02868	M1/2" x F1/2"	0,07	10		cr / chr	5,52
G02869	M1/2" x F3/4"	0,05	10		cr / chr	4,19

Valvole minisfera / Mini ball valves



Valvola minisfera
femmina-femmina
cromata
Box 100 pz.

Mini ball valve female-
female, chrome plated
Box 100 pz.

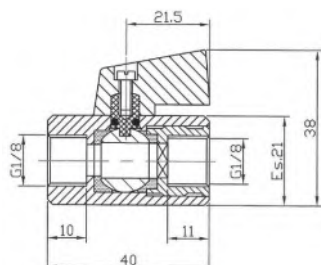

Cod.	Dim.	Kg/Pz.	Conf.	Pkg	Fin.	€
D907573	F1/8" x F1/8"	0,08	20		cr / chr	7,56
D907673	F1/4" x F1/4"	0,10	20		cr / chr	6,76
D907773	F3/8" x F3/8"	0,08	20		cr / chr	6,63
D907873	F1/2" x F1/2"	0,13	20		cr / chr	8,66
D907973	F3/4" x F3/4"	0,19	15		cr / chr	15,12



Valvola minisfera
maschio-femmina
cromata
Box 100 pz.

Mini ball valve male-
female, chrome plated
Box 100 pz.

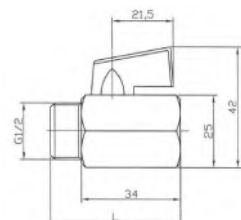

Cod.	Dim.	Kg/Pz.	Conf.	Pkg	Fin.	€
D908073	M1/8" x F1/8"	0,08	20		cr / chr	6,76
D908173	M1/4" x F1/4"	0,08	20		cr / chr	6,58
D908273	M3/8" x F3/8"	0,08	20		cr / chr	6,42
D908373	M1/2" x F1/2"	0,12	20		cr / chr	8,44
D908473	M3/4" x F3/4"	0,18	15		cr / chr	14,37



Valvola minisfera
maschio-maschio
cromata
Box 100 pz.

Mini ball valve male-
male, chrome plated
Box 100 pz.

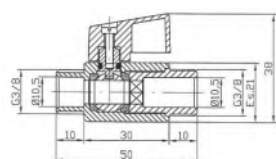

Cod.	Dim.	Kg/Pz.	Conf.	Pkg	Fin.	€
D908573	M1/4" x M1/4"	0,09	20		cr / chr	7,18
D908673	M3/8" x M3/8"	0,10	20		cr / chr	7,12
D908773	M1/2" x M1/2"	0,12	20		cr / chr	8,83



made in Italy



La tecnologia che semplifica
dal 1961

La serie di raccordi propone articoli di elevata qualità e spessore che garantiscono un perfetto funzionamento nel tempo. La gamma è in ottone giallo e cromato, in diverse lunghezze e filettature.

Fittings are offered with high quality standards, to ensure perfect operation over time. The range is in chromed and in yellow brass, proposed in different lengths and threads.

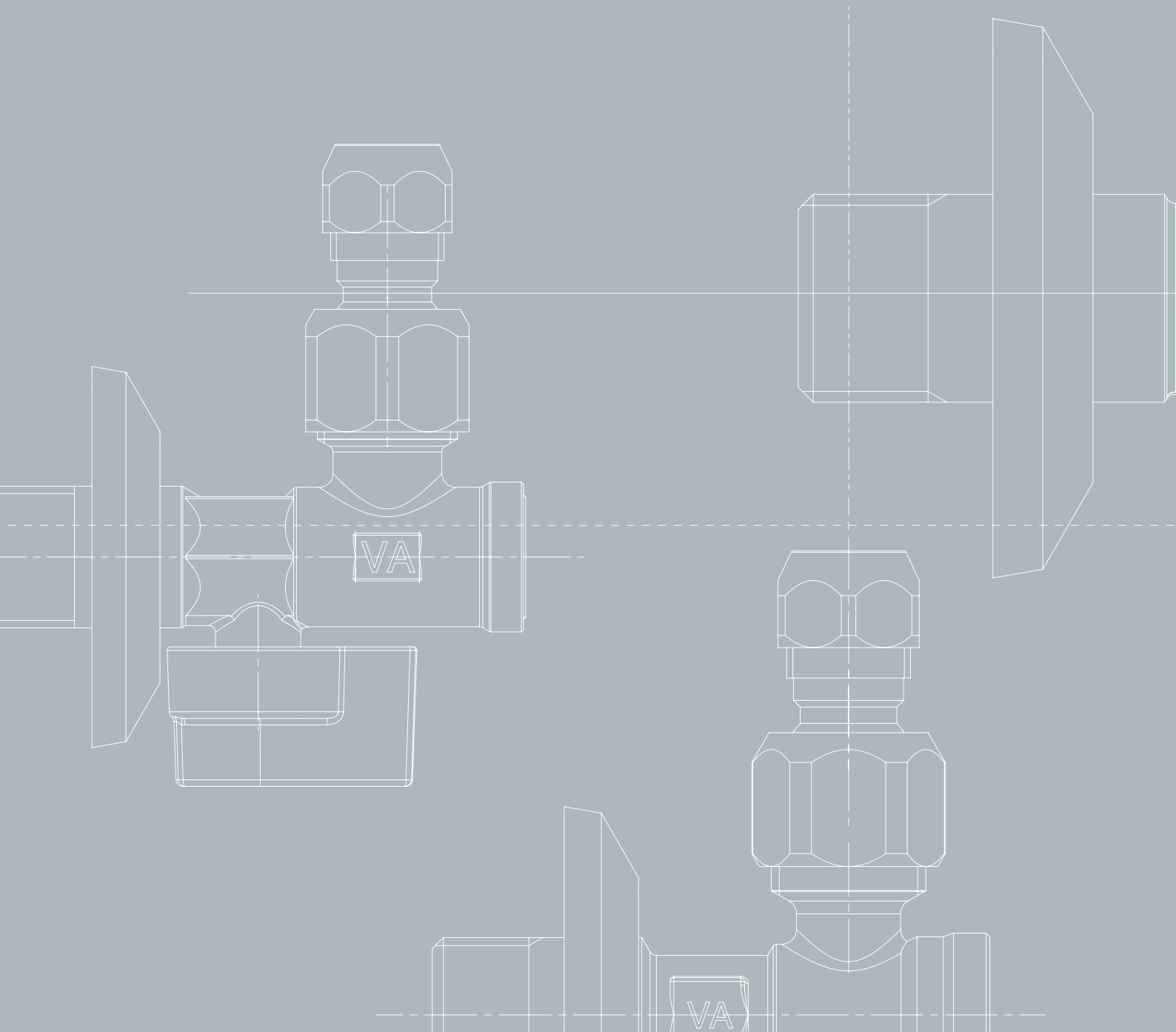

Raccordi
Fittings

Dadi
Nuts

Guarnizioni
Washers

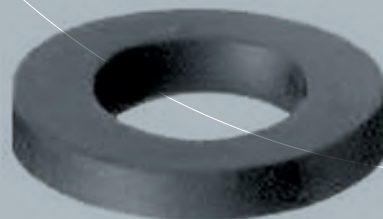
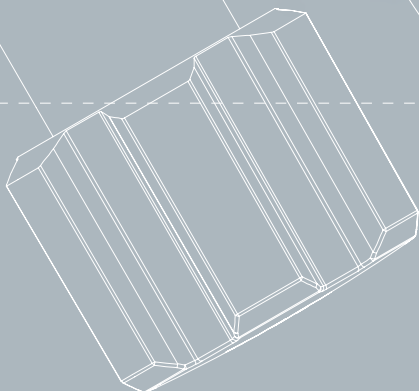
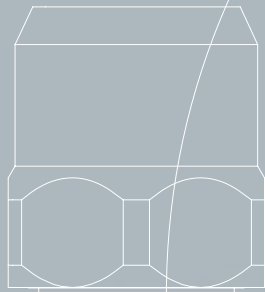

Raccordi / Fittings

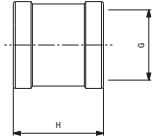

Manicotto femmina,
ottone
Box 250 pz.

Female brass coupling
Box 250 pz.

Cod.	Dim.	Kg/Pz.	Conf.	Pkg	Fin.	€
G03100	F1/4"	0,02	10		gg / br raw	1,48
G03102	F3/8"	0,03	10		gg / br raw	2,03
G03104	F1/2"	0,04	10		gg / br raw	3,30
G03106	F3/4"	0,06	10		gg / br raw	3,27
G03108	F1"	0,14	5		gg / br raw	6,45
G03110	F1" 1/4	0,14	5		gg / br raw	7,88
G03112	F1" 1/2	0,22	5		gg / br raw	13,36
G03114	F2"	0,41	5		gg / br raw	17,84
G03099	F1/4"	0,02	25		cr / chr	1,67
G03101	F3/8"	0,03	25		cr / chr	2,23
G03103	F1/2"	0,04	10		cr / chr	2,98
G03105	F3/4"	0,06	10		cr / chr	3,82
G03107	F1"	0,14	5		cr / chr	7,04
G03109	F1" 1/4	0,12	5		cr / chr	8,35
G03111	F1" 1/2	0,22	5		cr / chr	14,32
G03113	F2"	0,41	5		cr / chr	23,87

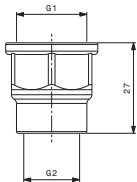

Manicotto ridotto
femmina-femmina, in
ottone
Box 500 pz.

Brass female reducer
coupling
Box 500 pz.

Cod.	Dim.	Kg/Pz.	Conf.	Pkg	Fin.	€
G03420	F1/2" x F3/8"	0,04	25		gg / br raw	2,74
G03421	F3/4" x F1/2"	0,07	10		gg / br raw	4,03
G03422	F1" x F3/4"	0,09	10		gg / br raw	4,91
G03423	F1"1/4 x F1"	0,21	10		gg / br raw	9,63
G03410	F1/2" x F3/8"	0,04	10		cr / chr	3,30
G03411	F3/4" x F1/2"	0,07	10		cr / chr	4,44
G03412	F1" x F3/4"	0,09	10		cr / chr	5,82
G03413	F1"1/4 x F1"	0,14	10		cr / chr	9,95

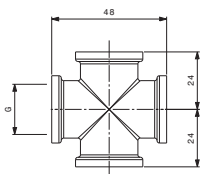

Raccordo a crociera
femmina, ottone
Box 100 pz.

Brass female cross
Box 100 pz.

Cod.	Dim.	Kg/Pz.	Conf.	Pkg	Fin.	€
G03034	F1/2"	0,10	10		gg / br raw	7,15
G03036	F3/4"	0,29	10		gg / br raw	11,35
G03038	F1"	0,28	5		gg / br raw	16,74

Raccordi / Fittings



Curva 90° maschio-femmina, ottone
Box 250 pz.

Brass male-female 90° elbow
Box 250 pz.

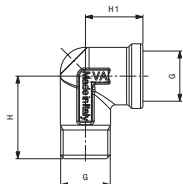

Cod.	Dim.	Kg/Pz.	Conf.	Pkg	Fin.	€
G03180	M1/4" x F1/4"	0,04	10		gg / br raw	3,49
G03182	M3/8" x F3/8"	0,06	10		gg / br raw	3,83
G03184	M1/2" x F1/2"	0,08	5		gg / br raw	3,33
G03186	M3/4" x F3/4"	0,11	10		gg / br raw	5,87
G03188	M1" x F1"	0,20	5		gg / br raw	9,54
G03190	M1"1/4 x F1"1/4	0,29	5		gg / br raw	15,99
G03192	M1"1/2 x F1"1/2	0,40	5		gg / br raw	23,15
G03194	M2" x F2"	0,74	5		gg / br raw	43,90
G03179	M1/4" x F1/4"	0,04	25		cr / chr	4,31
G03181	M3/8" x F3/8"	0,06	5		cr / chr	3,60
G03183	M1/2" x F1/2"	0,08	5		cr / chr	4,30
G03185	M3/4" x F3/4"	0,11	10		cr / chr	6,45
G03187	M1" x F1"	0,20	5		cr / chr	12,17
G03189	M1"1/4 x F1"1/4	0,29	5		cr / chr	17,42
G03191	M1"1/2 x F1"1/2	0,40	5		cr / chr	23,87
G03193	M2" x F2"	0,74	5		cr / chr	34,62



Curva 90° femmina, ottone
Box 250 pz.

Brass female 90° elbow
Box 250 pz.

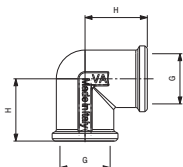

Cod.	Dim.	Kg/Pz.	Conf.	Pkg	Fin.	€
G03120	F1/4"	0,04	25		gg / br raw	3,57
G03122	F3/8"	0,06	10		gg / br raw	3,46
G03124	F1/2"	0,09	10		gg / br raw	4,16
G03126	F3/4"	0,11	10		gg / br raw	5,44
G03128	F1"	0,21	5		gg / br raw	10,27
G03130	F1" 1/4	0,31	5		gg / br raw	16,70
G03132	F1" 1/2	0,31	5		gg / br raw	23,87
G03134	F2"	0,81	5		gg / br raw	43,86
G03119	F1/4"	0,04	10		cr / chr	4,31
G03121	F3/8"	0,06	10		cr / chr	4,66
G03123	F1/2"	0,07	5		cr / chr	4,38
G03125	F3/4"	0,11	10		cr / chr	6,69
G03127	F1"	0,21	5		cr / chr	12,30
G03129	F1" 1/4	0,32	5		cr / chr	18,38
G03131	F1" 1/2	0,31	5		cr / chr	26,26
G03133	F2"	0,81	5		cr / chr	46,54



Raccordo a Y maschio-femmina, ottone
Box 200 pz.

Brass male-female Y
Box 200 pz.

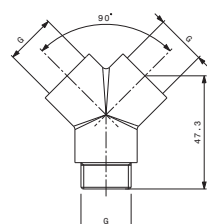

Cod.	Dim.	Kg/Pz.	Conf.	Pkg	Fin.	€
G03003	M1/2" x F1/2"	0,13	5		gg / br raw	9,22
G03004	M1/2" x F1/2"	0,12	10		cr / chr	9,66

Raccordi / Fittings



Raccordo a T femmina, ottone
Box 200 pz.

Brass coupling tee
Box 200 pz.

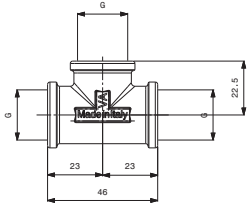

Cod.	Dim.	Kg/Pz.	Conf.	Pkg	Fin.	€
G03174	F1/4"	0,05	10		gg / br raw	4,46
G03152	F3/8"	0,07	10		gg / br raw	4,53
G03154	F1/2"	0,08	5		gg / br raw	4,35
G03156	F3/4"	0,13	10		gg / br raw	5,69
G03158	F1"	0,25	5		gg / br raw	11,33
G03160	F1" 1/4	0,40	5		gg / br raw	20,52
G03162	F1" 1/2	0,60	5		gg / br raw	30,55
G03164	F2"	0,66	5		gg / br raw	39,86
G03173	F1/4"	0,06	10		cr / chr	5,37
G03151	F3/8"	0,06	10		cr / chr	5,63
G03153	F1/2"	0,08	5		cr / chr	4,22
G03155	F3/4"	0,12	10		cr / chr	6,80
G03157	F1"	0,24	5		cr / chr	13,36
G03159	F1" 1/4	0,42	5		cr / chr	22,44
G03161	F1" 1/2	0,60	5		cr / chr	31,51
G03163	F2"	0,66	5		cr / chr	41,30
G03172	F3/4" x F1/2" x F3/4" ridotto F3/4" x F1/2" x F3/4" reduced	0,13	10		gg / br raw	6,69
G03170	F1" x F1/2" x F1" ridotto F1" x F1/2" x F1" reduced	0,27	5		gg / br raw	14,09
G03171	F3/4" x F1/2" x F3/4" ridotto F3/4" x F1/2" x F3/4" reduced	0,13	5		cr / chr	7,57



Raccordo maschio-femmina, speciale per pilette, ottone
Box 200 pz.

Brass male-female hexagonal bushing special for drains
Box 200 pz.

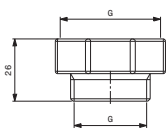

Cod.	Dim.	Kg/Pz.	Conf.	Pkg	Fin.	€
G032465	M1" x F1"1/4	0,09	10		cr / chr	5,03
G032466	M1"1/4 x F1"1/2	0,10	10		cr / chr	7,11

Raccordi / Fittings



Raccordo maschio-femmina, ottone
Box 500 pz.

Brass male-female bushing, high hexagon
Box 500 pz.

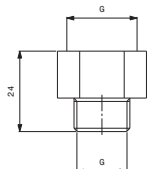

Cod.	Dim.	Kg/Pz.	Conf.	Pkg	Fin.	€
G03242	M3/8" x F3/8"	0,02	10		gg / br raw	1,96
G03139	M3/8" x F1/2"	0,03	10		gg / br raw	1,96
G03244	M1/2" x F1/2"	0,03	10		gg / br raw	2,74
G03140	M1/2" x F3/4"	0,04	10		gg / br raw	3,01
G03241	M3/8" x F3/8"	0,02	10		cr / chr	2,14
G03141	M3/8" x F1/2"	0,03	10		cr / chr	2,14
G03243	M1/2" x F1/2"	0,03	10		cr / chr	2,87
G03246	M1/2" x F3/4"	0,04	10		cr / chr	3,09



Raccordo a riduzione, maschio-femmina, ottone
Box 500 pz.

Brass male-female hexagonal bushing
Box 500 pz.

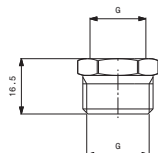

Cod.	Dim.	Kg/Pz.	Conf.	Pkg	Fin.	€
G03240	M3/8" x F1/4"	0,01	10		gg / br raw	1,36
G03138	M1/2" x F3/8"	0,02	10		gg / br raw	2,14
G03150	M1/2" x F1/4"	0,03	25		gg / br raw	1,96
G03148	M3/4" x F3/8"	0,06	10		gg / br raw	2,91
G03248	M3/4" x F1/2"	0,03	10		gg / br raw	2,19
G03250	M1" x F3/8"	0,10	5		gg / br raw	5,75
G03259	M1" x F1/2"	0,08	5		gg / br raw	4,78
G03258	M1" x F3/4"	0,06	10		gg / br raw	3,57
G032561	M1"1/4 x F1/2"	0,20	5		gg / br raw	9,06
G03256	M1"1/4 x F3/4"	0,14	10		gg / br raw	7,85
G03252	M1"1/4 x F1"	0,11	10		gg / br raw	6,11
G03254	M1"1/2 x F1"1/4	0,13	10		gg / br raw	6,64
G03257	M2" x F1"1/2	0,26	5		gg / br raw	15,08
G032401	M3/8" x F1/4"	0,01	10		cr / chr	1,60
G03245	M1/2" x F3/8"	0,02	10		cr / chr	2,37
G03247	M3/4" x F1/2"	0,03	10		cr / chr	2,39
G032501	M1" x F3/8"	0,10	5		cr / chr	6,21
G031465	M1"1/2 x F1"	0,05	5		cr / chr	9,19
G03249	M1" x F3/4"	0,06	10		cr / chr	3,81
G03251	M1"1/4 x F1"	0,12	10		cr / chr	6,97
G03253	M1"1/2 x F1"1/4	0,13	5		cr / chr	7,10
G03255	M2" x F1"1/2	0,26	5		cr / chr	12,12

Raccordi / Fittings



Vite doppia ridotta,
ottone
Box 1000 pz.

Brass reducing nipple
Box 1000 pz.

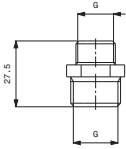

Cod.	Dim.	Kg/Pz.	Conf.	Pkg	Fin.	€
G032208	M3/8" x M1/4"	0,02	25		gg / br raw	1,53
G03222	M1/2" x M3/8"	0,03	10		gg / br raw	1,87
G03224	M3/4" x M1/2"	0,05	10		gg / br raw	2,98
G03226	M1" x M3/4"	0,09	5		gg / br raw	5,26
G03228	M1"1/4 x M1"	0,14	5		gg / br raw	7,51
G03230	M1"1/2 x M1"1/4	0,19	5		gg / br raw	10,22
G03232	M2" x M1"1/2	0,30	5		gg / br raw	18,20
G032209	M3/8" x M1/4"	0,02	25		cr / chr	1,88
G03221	M1/2" x M3/8"	0,03	10		cr / chr	2,02
G03223	M3/4" x M1/2"	0,05	10		cr / chr	3,13
G03225	M1" x M3/4"	0,09	5		cr s / chr s	5,59
G03227	M1"1/4 x M1"	0,14	5		cr s / chr s	8,14
G03229	M1"1/2 x M1"1/4	0,18	5		cr s / chr s	11,22
G03231	M2" x M1"1/2	0,30	5		cr s / chr s	19,44



Vite doppia, ottone
Box 1000 pz.

Brass nipple
Box 1000 pz.

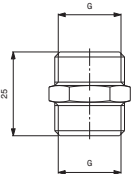

Cod.	Dim.	Kg/Pz.	Conf.	Pkg	Fin.	€
G03200	M1/4"	0,01	25		gg / br raw	1,29
G03202	M3/8"	0,02	10		gg / br raw	1,19
G03204	M1/2"	0,03	10		gg / br raw	1,85
G03206	M3/4"	0,05	10		gg / br raw	2,67
G03208	M1"	0,09	10		gg / br raw	4,56
G03210	M1"1/4	0,15	5		gg / br raw	8,26
G03212	M1"1/2	0,19	5		gg / br raw	10,32
G03214	M2"	0,32	5		gg / br raw	16,20
G03199	M1/4"	0,01	10		cr / chr	1,43
G03201	M3/8"	0,02	10		cr / chr	1,30
G03203	M1/2"	0,03	10		cr / chr	2,02
G03205	M3/4"	0,05	10		cr / chr	2,97
G03207	M1"	0,09	10		cr s / chr s	5,03
G03209	M1"1/4	0,15	10		cr s / chr s	8,97
G03211	M1"1/2	0,19	5		cr s / chr s	10,71
G03213	M2"	0,32	5		cr s / chr s	17,44



Ghiera maschio-
femmina, ottone
Box 1500 pz.

Brass female-male
simple bushing
Box 1500 pz.

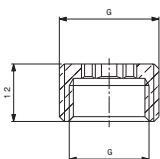

Cod.	Dim.	Kg/Pz.	Conf.	Pkg	Fin.	€
G03401	M1/2" x F3/8"	0,01	10		cr / chr	1,01
G03402	M3/4" x F1/2"	0,02	10		cr / chr	2,46
G03403	M1/2" x F3/8" foro esa per chiave M1/2" x F3/8" hexagonal hole	0,01	10		cr / chr	1,38
G03404	M3/4" x F1/2"	0,02	10		cr / chr	2,06

Raccordi / Fittings



Tappo maschio con chiave quadra, ottone
Box 500 pz.

Square head brass pipe
plug, male
Box 500 pz.

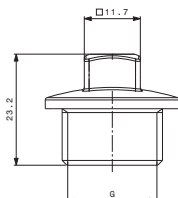

Cod.	Dim.	Kg/Pz.	Conf.	Pkg	Fin.	€
G03264	M1/2"	0,03	10		gg / br raw	2,01
G03266	M3/4"	0,04	10		gg / br raw	2,93
G03263	M1/2"	0,03	10		cr / chr	2,19
G03265	M3/4"	0,05	25		cr / chr	3,42



Tappo esagonale
femmina, ottone
Box 500 pz.

Hexagonal brass pipe
plug, female
Box 500 pz.

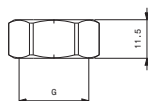

Cod.	Dim.	Kg/Pz.	Conf.	Pkg	Fin.	€
G03305	F3/8"	0,01	25		gg / br raw	1,24
G03306	F1/2"	0,03	25		gg / br raw	1,57
G03307	F3/4"	0,03	25		gg / br raw	1,98
G03308	F1"	0,06	10		gg / br raw	3,24
G03295	F3/8"	0,01	25		cr / chr	1,48
G03296	F1/2"	0,03	25		cr / chr	1,88
G03297	F3/4"	0,03	10		cr / chr	2,18
G03298	F1"	0,06	10		cr / chr	3,80



Tappo maschio
esagonale, ottone
Box 500 pz.

Hexagonal brass pipe
plug, male
Box 500 pz.

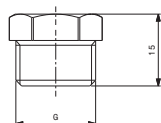

Cod.	Dim.	Kg/Pz.	Conf.	Pkg	Fin.	€
G03324	M1/4"	0,01	25		gg / br raw	1,19
G03325	M3/8"	0,01	25		gg / br raw	1,40
G03326	M1/2"	0,02	25		gg / br raw	1,53
G03327	M3/4"	0,04	25		gg / br raw	2,38
G03328	M1"	0,06	10		gg / br raw	3,93
G03329	M1"1/4	0,10	10		gg / br raw	6,11
G03330	M1"1/2	0,15	10		gg / br raw	10,05
G03331	M2"	0,25	10		gg / br raw	17,44
G03314	M1/4"	0,01	25		cr / chr	1,51
G03315	M3/8"	0,02	25		cr / chr	1,71
G03316	M1/2"	0,02	25		cr / chr	1,85
G03317	M3/4"	0,04	25		cr / chr	2,71
G03318	M1"	0,06	10		cr / chr	4,19
G03319	M1"1/4	0,11	10		cr / chr	6,48
G03320	M1"1/2	0,20	10		cr / chr	11,46
G03321	M2"	0,25	10		cr / chr	17,60

Raccordi / Fittings



Tappo con vite e rosone, ottone
Box 100 pz.

Screw plug with cover plate
Box 100 pz.

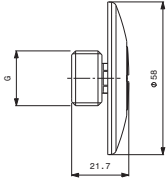

Cod.	Dim.	Kg/Pz.	Conf.	Pkg	Fin.	€
G03281	M3/8"	0,04	1		cr / chr	3,87
G03282	M1/2"	0,06	1		cr / chr	4,61
G03283	M3/4"	0,07	1		cr / chr	5,68



Tappo con vite, ottone
Box 100 pz.

Screw plug without cover plate
Box 100 pz.

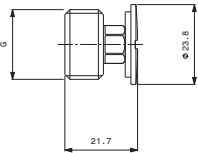

Cod.	Dim.	Kg/Pz.	Conf.	Pkg	Fin.	€
G03291	M3/8"	0,04	10		cr / chr	3,30
G03292	M1/2"	0,05	1		cr / chr	3,50
G03293	M3/4"	0,06	10		cr / chr	4,83



Controdado con flangia, ottone
Box 500 pz.

Brass flanged back nut
Box 500 pz.

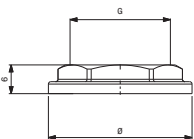

Cod.	Dim.	Kg/Pz.	Conf.	Pkg	Fin.	€
G03521	M3/8"	0,03	10		gg s / br s	1,78
G03522	M1/2"	0,04	10		gg s / br s	2,29
G03523	M3/4"	0,04	10		gg s / br s	2,63
G03524	M1"	0,06	10		gg s / br s	3,06
G03525	M1" 1/4	0,08	10		gg s / br s	4,43
G03526	M1" 1/2	0,10	10		gg s / br s	5,97
G03531	M3/8"	0,03	25		cr s / chr s	1,17
G03532	M1/2"	0,04	10		cr s / chr s	2,66
G03533	M3/4"	0,04	25		cr s / chr s	2,46
G03534	M1"	0,06	10		cr s / chr s	3,75
G03535	M1" 1/4	0,08	10		cr s / chr s	5,27
G03536	M1" 1/2	0,11	10		cr s / chr s	7,37

Raccordi / Fittings



Raccordo ottone
tuttofiletto
Box 500 pz.

Brass threaded nipple
Box 500 pz.

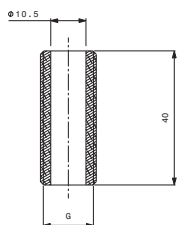

Cod.	Dim.	Kg/Pz.	Conf.	Pkg	Fin.	€
G03511	M3/8"	0,03	50		gg / br raw	2,39
G03512	M1/2"	0,03	10		gg / br raw	2,15
G03513	M3/4"	0,05	10		gg / br raw	2,78
G03514	M1"	0,06	10		gg / br raw	5,37
G03501	M3/8"	0,06	10		cr / chr	3,12
G03502	M1/2"	0,03	10		cr / chr	2,23
G03503	M3/4"	0,05	10		cr / chr	3,30
G03504	M1"	0,09	10		cr / chr	5,42

Barilotto filettato,
ottone, maschio
Box 250 pz.

Threaded brass pipe,
male
Box 250 pz.

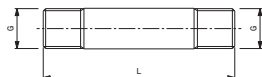

Cod.	Dim.	L. mm	Kg/Pz.	Conf.	Pkg	Fin.	€
K07910	M3/8"	60	0,06	10		gg / br raw	3,37
K07911	M3/8"	80	0,08	10		gg / br raw	4,25
K07912	M3/8"	100	0,11	10		gg / br raw	5,06
K07913	M3/8"	150	0,13	10		gg / br raw	7,12
K07920	M1/2"	60	0,09	10		gg / br raw	4,06
K07921	M1/2"	80	0,10	10		gg / br raw	5,06
K07922	M1/2"	100	0,14	10		gg / br raw	6,30
K07923	M1/2"	150	0,19	10		gg / br raw	9,06
K07930	M3/4"	60	0,11	10		gg / br raw	5,07
K07931	M3/4"	80	0,16	10		gg / br raw	6,48
K07932	M3/4"	100	0,19	10		gg / br raw	7,87
K07933	M3/4"	150	0,32	5		gg / br raw	11,57
K07934	M1"	60	0,16	5		gg / br raw	6,98
K07935	M1"	80	0,18	10		gg / br raw	8,93
K07936	M1"	100	0,20	10		gg / br raw	10,94
K07937	M1"	150	0,35	10		gg / br raw	16,08
K07938	M1"1/4	60	0,28	10		gg / br raw	11,28
K07939	M1"1/4	80	0,39	10		gg / br raw	15,17
K07940	M1"1/4	100	0,47	10		gg / br raw	18,67
K07941	M1"1/4	150	0,56	10		gg / br raw	27,45
K07970	M3/8"	60	0,09	10		cr / chr	3,59
K07971	M3/8"	80	0,09	10		cr / chr	4,46
K07972	M3/8"	100	0,11	5		cr / chr	5,30
K07950	M1/2"	60	0,08	2		cr / chr	4,98
K07954	M1/2"	80	0,11	2		cr / chr	5,92
K07955	M1/2"	100	0,14	2		cr / chr	7,11

Raccordi / Fittings

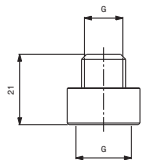

Prolunga ridotta,
ottone
Box 500 pz.

Brass male-female
reducer threaded
extension
Box 500 pz.

Cod.	Dim.	Kg/Pz.	Conf.	Pkg	Fin.	€
K07810	M1/4" x F3/8"	0,02	10		gg / br raw	1,57
K07811	M3/8" x F1/2"	0,05	10		gg / br raw	2,40
K07812	M1/2" x F3/4"	0,07	10		gg / br raw	3,67
K07813	M3/4" x F1"	0,07	10		gg / br raw	4,03
K07814	M1" x F1"1/4	0,11	10		gg / br raw	6,26
K07820	M1/4" x F3/8"	0,02	25		cr / chr	2,19
K07821	M3/8" x F1/2"	0,05	10		cr / chr	2,79
K07822	M1/2" x F3/4"	0,07	10		cr / chr	4,18
K07823	M3/4" x F1"	0,08	10		cr / chr	4,56
K07824	M1" x F1"1/4	0,11	10		cr / chr	6,96

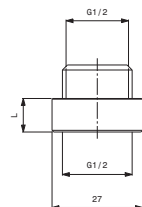

Prolunga ottone 1/2"
"ROMA", foro tondo
diametro interno 14
mm
Box 500 pz.

Brass threaded
extension "ROMA" 1/2",
internal diameter 14 mm
Box 500 pz.

Cod.	Dim.	ø est.	L. mm	Kg/Pz.	Conf.	Pkg	Fin.	€
K08441	M1/2" x F1/2"	27	10	0,04	10		cr / chr	2,38
K08442	M1/2" x F1/2"	27	15	0,05	10		cr / chr	2,64
K08443	M1/2" x F1/2"	27	20	0,06	10		cr / chr	3,14
K08444	M1/2" x F1/2"	27	25	0,07	10		cr / chr	3,59
K08445	M1/2" x F1/2"	27	30	0,08	10		cr / chr	4,06
K08446	M1/2" x F1/2"	27	40	0,10	10		cr / chr	5,46
K08447	M1/2" x F1/2"	27	50	0,13	10		cr / chr	6,58
K08448	M1/2" x F1/2"	27	60	0,15	10		cr / chr	8,08
K08449	M1/2" x F1/2"	27	80	0,20	10		cr / chr	10,86
K08450	M1/2" x F1/2"	27	100	0,25	10		cr / chr	12,35

Raccordi / Fittings



Prolunga ottone
pesante, con esagono.
Normalizzata
Box 500 pz.

Brass threaded
extension with hexagon
Box 500 pz.

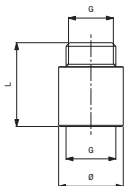

Cod.	Dim.	ø est.	L. mm	Kg/Pz.	Conf.	Pkg	Fin.	€
K08131	M3/8" x F3/8"	20	10	0,02	10		gg / br raw	1,51
K08132	M3/8" x F3/8"	20	15	0,03	10		gg / br raw	2,11
K08133	M3/8" x F3/8"	20	20	0,04	10		gg / br raw	2,19
K08134	M3/8" x F3/8"	20	25	0,05	10		gg / br raw	2,56
K08135	M3/8" x F3/8"	20	30	0,06	10		gg / br raw	2,84
K08136	M3/8" x F3/8"	20	40	0,06	10		gg / br raw	3,52
K08137	M3/8" x F3/8"	20	50	0,09	10		gg / br raw	4,19
K08138	M3/8" x F3/8"	20	60	0,10	10		gg / br raw	4,79
K08139	M3/8" x F3/8"	20	80	0,12	10		gg / br raw	5,39
K08011	M1/2" x F1/2"	27	10	0,04	10		gg / br raw	2,30
K08012	M1/2" x F1/2"	27	15	0,05	10		gg / br raw	2,56
K08013	M1/2" x F1/2"	27	20	0,06	10		gg / br raw	3,03
K08014	M1/2" x F1/2"	27	25	0,07	10		gg / br raw	3,52
K08015	M1/2" x F1/2"	27	30	0,08	10		gg / br raw	3,83
K08016	M1/2" x F1/2"	27	40	0,11	10		gg / br raw	5,23
K08017	M1/2" x F1/2"	27	50	0,12	10		gg / br raw	6,34
K08018	M1/2" x F1/2"	27	60	0,15	10		gg / br raw	7,95
K08019	M1/2" x F1/2"	27	80	0,22	10		gg / br raw	10,15
K08020	M1/2" x F1/2"	27	100	0,24	10		gg / br raw	12,09
K08021	M3/4" x F3/4"	32	10	0,06	10		gg / br raw	3,67
K08022	M3/4" x F3/4"	32	15	0,06	10		gg / br raw	4,01
K08023	M3/4" x F3/4"	32	20	0,07	10		gg / br raw	4,55
K08024	M3/4" x F3/4"	32	25	0,09	10		gg / br raw	5,12
K08025	M3/4" x F3/4"	32	30	0,11	10		gg / br raw	5,59
K08026	M3/4" x F3/4"	32	40	0,14	10		gg / br raw	6,87
K08027	M3/4" x F3/4"	32	50	0,15	10		gg / br raw	8,32
K08028	M1" x F1"	40	10	0,09	10		gg / br raw	5,53
K08029	M1" x F1"	40	15	0,11	10		gg / br raw	6,00
K08030	M1" x F1"	40	20	0,12	10		gg / br raw	6,80
K08031	M1" x F1"	40	30	0,16	10		gg / br raw	8,56
K08033	M1" x F1"	40	50	0,24	10		gg / br raw	12,28
K08101	M3/8" x F3/8"	20	10	0,03	10		cr / chr	1,80
K08102	M3/8" x F3/8"	20	15	0,03	10		cr / chr	2,16
K08103	M3/8" x F3/8"	20	20	0,04	10		cr / chr	2,48
K08104	M3/8" x F3/8"	20	25	0,05	10		cr / chr	2,70
K08105	M3/8" x F3/8"	20	30	0,06	10		cr / chr	3,14
K08106	M3/8" x F3/8"	20	40	0,07	10		cr / chr	4,03
K08107	M3/8" x F3/8"	20	50	0,09	10		cr / chr	4,96
K08108	M3/8" x F3/8"	20	60	0,11	10		cr / chr	5,98
K08109	M3/8" x F3/8"	20	80	0,12	10		cr / chr	6,83
K08110	M3/8" x F3/8"	20	100	0,02	10		cr / chr	13,09
K08041	M1/2" x F1/2"	27	10	0,04	10		cr / chr	2,58
K08042	M1/2" x F1/2"	27	15	0,05	10		cr / chr	2,88
K08043	M1/2" x F1/2"	27	20	0,06	10		cr / chr	3,34
K08044	M1/2" x F1/2"	27	25	0,07	10		cr / chr	3,86
K08045	M1/2" x F1/2"	27	30	0,08	10		cr / chr	4,31
K08046	M1/2" x F1/2"	27	40	0,11	10		cr / chr	5,40
K08047	M1/2" x F1/2"	27	50	0,12	10		cr / chr	6,64
K08048	M1/2" x F1/2"	27	60	0,15	10		cr / chr	8,41
K08049	M1/2" x F1/2"	27	80	0,20	10		cr / chr	10,78
K08050	M1/2" x F1/2"	27	100	0,25	10		cr / chr	12,66
K08051	M3/4" x F3/4"	32	10	0,06	10		cr / chr	4,18
K08052	M3/4" x F3/4"	32	15	0,07	10		cr / chr	4,51
K08053	M3/4" x F3/4"	32	20	0,08	10		cr / chr	5,08
K08054	M3/4" x F3/4"	32	25	0,09	10		cr / chr	4,96
K08055	M3/4" x F3/4"	32	30	0,10	10		cr / chr	5,69
K08056	M3/4" x F3/4"	32	40	0,13	10		cr / chr	7,53
K08057	M3/4" x F3/4"	32	50	0,15	10		cr / chr	9,27
K08058	M1" x F1"	40	10	0,09	10		cr / chr	5,88
K08059	M1" x F1"	40	15	0,11	10		cr / chr	6,84
K08060	M1" x F1"	40	20	0,12	10		cr / chr	7,15
K08061	M1" x F1"	40	30	0,16	10		cr / chr	9,01
K08063	M1" x F1"	40	50	0,24	10		cr / chr	12,91



Raccordi / Fittings



Raccordo tre pezzi
diritto maschio-
femmina, sede conica
con OR, ottone
Box 100 pz.

Straight union joint,
male-female outlets,
conical, with OR, brass
Box 100 pz.

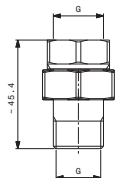

Cod.	Dim.	Kg/Pz.	Conf.	Pkg	Fin.	€
K052202	M1/2" x F1/2"	0,10	5		gg / br raw	6,80
K052203	M3/4" x F3/4"	0,17	5		gg / br raw	9,37
K052204	M1" x F1"	0,29	5		gg / br raw	16,14
K052252	M1/2" x F1/2"	0,10	5		nich / nik	7,59
K052253	M3/4" x F3/4"	0,17	5		nich / nik	10,08
K052254	M1" x F1"	0,29	5		nich / nik	17,27



Raccordo tre pezzi
90°, maschio-
femmina, sede conica
con OR, ottone
Box 100 pz.

90° union joint, male-
female outlets, conical,
with OR, brass
Box 100 pz.

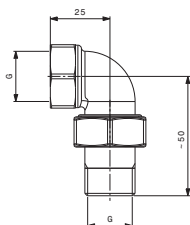

Cod.	Dim.	Kg/Pz.	Conf.	Pkg	Fin.	€
K052352	M1/2" x F1/2"	0,14	5		nich / nik	9,64
K052353	M3/4" x F3/4"	0,21	5		nich / nik	14,19
K052354	M1" x F1"	0,36	5		nich / nik	23,11

Raccordi / Fittings



Eccentrico per gruppo
parete, ottone
Box 100 pz.

Eccentric, brass,
chrome plated
Box 100 pz.

Cod.	Dim.	L. mm	Kg/Pz.	Conf.	Pkg	Fin.	€
K03310	M1/2" x M3/4"	10	0,08	1		cr / chr	7,48
K03320	M1/2" x M3/4"	20	0,12	1		cr / chr	9,10



Eccentrico per
radiatore, ottone
nichelato
Box 100 pz.

Eccentric for radiator,
brass nickel plated
Box 100 pz.

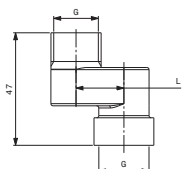

Cod.	Dim.	L. mm	Kg/Pz.	Conf.	Pkg	Fin.	€
K013810	M3/8" x F3/8"	10	0,11	10		cr / chr	9,93
K013820	M3/8" x F3/8"	20	0,10	10		cr / chr	7,66
K013830	M3/8" x F3/8"	30	0,11	10		cr / chr	8,16
K013840	M3/8" x F3/8"	40	0,13	10		cr / chr	8,68
K013850	M3/8" x F3/8"	50	0,15	10		cr / chr	9,10
K013860	M3/8" x F3/8"	60	0,15	10		cr / chr	9,51
K011210	M1/2" x F1/2"	10	0,10	10		cr / chr	9,59
K011220	M1/2" x F1/2"	20	0,09	10		cr / chr	7,66
K011230	M1/2" x F1/2"	30	0,11	10		cr / chr	8,16
K011240	M1/2" x F1/2"	40	0,12	10		cr / chr	8,68
K011250	M1/2" x F1/2"	50	0,14	10		cr / chr	9,10
K011260	M1/2" x F1/2"	60	0,14	10		cr / chr	9,51



Eccentrico per
radiatore, cromato
lucido
Box 100 pz.

Eccentric for radiator
polished-chrome
Box 100 pz.

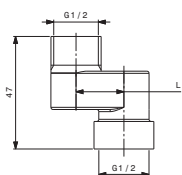

Cod.	Dim.	L. mm	Kg/Pz.	Conf.	Pkg	Fin.	€
K011520	M1/2" x F1/2"	20	0,08	5		cr / chr	16,51
K011530	M1/2" x F1/2"	30	0,09	5		cr / chr	17,83

Raccordi / Fittings



Raccordo diritto, dado conico basso
Box 500 pz.

Straight connection with compression nut nipple
Box 500 pz.

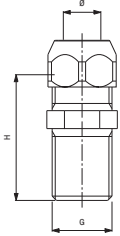

Cod.	Dim.	Kg/Pz.	Conf.	Pkg	Fin.	€
G02500	M3/8 x Ø8 H25	0,04	10		cr / chr	3,39
G02501	M3/8 x Ø10 H25	0,04	10		cr / chr	2,82
G02502	M3/8 x Ø12 H25	0,03	10		cr / chr	3,39
G02503	M1/2" x M3/8" x Ø10 H25	0,05	10		cr / chr	3,20
G02504	M1/2" x M3/8" x Ø12 H25	0,04	10		cr / chr	3,57
G02505	M1/2" x Ø10 H25	0,07	5		cr / chr	4,28
G02506	M1/2" x Ø12 H25	0,07	5		cr / chr	4,62
G025065	M1/2" x Ø14 H25	0,05	5		cr / chr	4,45
G02551	M3/8 x Ø10 H35	0,05	10		cr / chr	2,97
G02552	M3/8 x Ø12 H35	0,03	10		cr / chr	3,39
G02553	M1/2" x M3/8" x Ø10 H35	0,06	10		cr / chr	3,48
G02554	M1/2" x M3/8" x Ø12 H35	0,05	10		cr / chr	3,82



Raccordo diritto doppio, dadi conici
Box 500 pz.

Double connection with compression nuts
Box 500 pz.

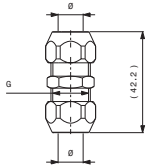

Cod.	Dim.	Kg/Pz.	Conf.	Pkg	Fin.	€
G02515	M3/8 x Ø8	0,06	10		cr / chr	5,13
G02516	M3/8 x Ø10	0,05	10		cr / chr	3,66
G02517	M3/8 x Ø12	0,04	10		cr / chr	4,48
G02519	M1/2" x Ø10	0,05	10		cr / chr	4,11
G02520	M1/2" x Ø12	0,09	5		cr / chr	6,42
G02521	M1/2" x Ø14	0,09	5		cr / chr	6,61
G02522	M3/8" Rid. speciale fori Ø 10-12 M3/8" Special reduction Ø 10-12	0,07	5		cr / chr	5,81



Raccordo maschio-femmina, dado conico
Box 500 pz.

Male-female connection with compression nut
Box 500 pz.

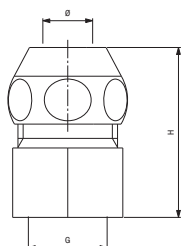

Cod.	Dim.	Kg/Pz.	Conf.	Pkg	Fin.	€
G02507	F3/8" x M3/8" x Ø8	0,04	10		cr / chr	3,67
G02508	F3/8" x M3/8" x Ø10	0,04	10		cr / chr	3,14
G02518	F3/8" x M3/8" x Ø12	0,03	10		cr / chr	3,73
G02509	F1/2" x M3/8" x Ø8	0,05	10		cr / chr	3,97
G02510	F1/2" x M3/8" x Ø10	0,04	10		cr / chr	3,12
G02511	F1/2" x M3/8" x Ø12	0,04	10		cr / chr	3,60
G02512	F1/2" x M1/2" x Ø10	0,07	5		cr / chr	4,89
G02513	F1/2" x M1/2" x Ø12	0,07	5		cr / chr	4,90
G02514	F1/2" x M1/2" x Ø14	0,05	5		cr / chr	4,92

Raccordi / Fittings



Raccordo a 90°, dadi conici bassi
Box 400 pz.

Elbow with compression nuts
Box 400 pz.

Cod.	Dim.	Kg/Pz.	Conf.	Pkg	Fin.	€
G02523	M3/8" x Ø8	0,07	5		cr / chr	7,08
G02524	M3/8" x Ø10	0,06	10		cr / chr	5,13
G02525	M3/8" x Ø12	0,05	10		cr / chr	5,78
G02528	M1/2" x Ø10	0,13	5		cr / chr	8,18
G02529	M1/2" x Ø12	0,11	5		cr / chr	8,14
G02530	M1/2" x Ø14	0,10	5		cr / chr	8,16

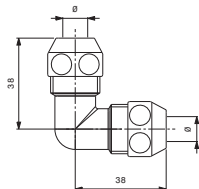

Raccordo a 90°, dado conico basse e codolo con dado girevole
Box 100 pz.

Elbow with compression nut, turnig nut
Box 100 pz.

Cod.	Dim.	Kg/Pz.	Conf.	Pkg	Fin.	€
G02531COD	F3/8" x Ø10	0,07	5		cr / chr	5,98

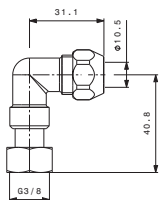

Raccordo a 90°, dado conico basso, attacco maschio
Box 400 pz.

Elbow with compression nut, male connection
Box 400 pz.

Cod.	Dim.	Kg/Pz.	Conf.	Pkg	Fin.	€
G02531	M3/8" x Ø10	0,05	10		cr / chr	4,21
G02532	M3/8" x Ø12	0,04	10		cr / chr	4,41
G02533	M1/2" x Ø10	0,11	5		cr / chr	6,29
G02534	M1/2" x Ø12	0,09	5		cr / chr	5,69
G02542	M1/2" x Ø14	0,08	5		cr / chr	5,65

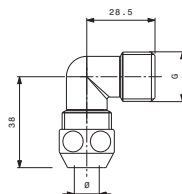

Raccordi / Fittings



Raccordo a T, dadi conici bassi
Box 250 pz.

Tee connection with compression nuts
Box 250 pz.

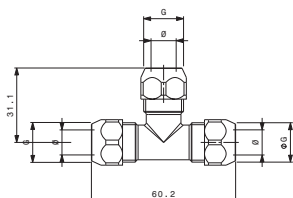

Cod.	Dim.	Kg/Pz.	Conf.	Pkg	Fin.	€
G02539	M3/8" x Ø8	0,10	5		cr / chr	8,50
G02540	M3/8" x Ø10	0,09	5		cr / chr	6,40
G02541	M3/8" x Ø12	0,07	5		cr / chr	7,39
G02544	M1/2" x Ø12	0,15	5		cr / chr	11,24



Raccordo a T, 2 dadi conici bassi e codolo con dado girevole
Box 100 pz.

Tee connection with compression nuts and turning nut
Box 100 pz.

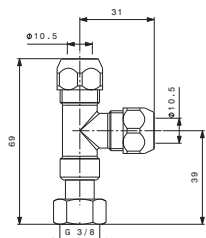

Cod.	Dim.	Kg/Pz.	Conf.	Pkg	Fin.	€
G02540COD	F3/8" x Ø10	0,09	5		cr / chr	7,83



Raccordo a croce con dado girevole
Box 400 pz.

Cross connection with turning nut
Box 400 pz.

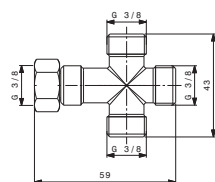

Cod.	Dim.	Kg/Pz.	Conf.	Pkg	Fin.	€
G02580COD	F3/8" x M3/8"	0,09	5		cr / chr	7,15
AGG02580COD	F3/8" x M3/8"	0,09	1		gg / br raw	6,84

Raccordi / Fittings



Raccordo 90°, dado conico basso, attacco femmina
Box 250 pz.

Elbow with compression nut, female connection
Box 250 pz.

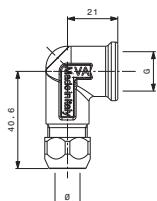

Cod.	Dim.	Kg/Pz.	Conf.	Pkg	Fin.	€
G02535	F3/8" x M3/8" x Ø10	0,09	5		cr / chr	4,60
G02536	F3/8" x M3/8" x Ø12	0,10	5		cr / chr	4,98
G02537	F1/2" x M3/8" x Ø10	0,10	5		cr / chr	5,54
G02538	F1/2" x M3/8" x Ø12	0,11	5		cr / chr	6,42



Raccordo 90°, alette di fissaggio, dado conico basso
Box 200 pz.

90° wall connection with fixing wings and compression nut
Box 200 pz.

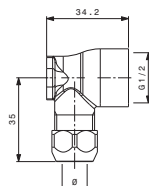

Cod.	Dim.	Kg/Pz.	Conf.	Pkg	Fin.	€
G02550	F1/2" x M3/8" x Ø10	0,09	5		cr / chr	7,64
G02549	F1/2" x M3/8" x Ø12	0,08	10		cr / chr	7,83



Raccordo 90°, placca di fissaggio, dado conico
Box 100 pz.

90° wall connection with fixing plate and compression nut
Box 100 pz.

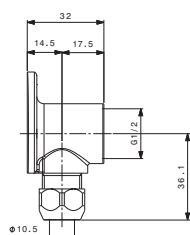

Cod.	Dim.	Kg/Pz.	Conf.	Pkg	Fin.	€
G02545	F1/2" x M3/8" x Ø10	0,14	1		cr / chr	8,54
G02546	F1/2" x M3/8" x Ø12	0,14	1		cr / chr	8,81

Dadi / Nuts



Dado normale
in ottone senza
guarnizioni
Box 1500 pz.

Brass nut without
washers
Box 1500 pz.

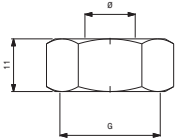

Cod.	Dim.	Kg/Pz.	Conf.	Pkg	Fin.	€
R10203	F3/8" x Ø12	0,01	25		gg / br raw	0,83
R10205	F1/2" x Ø10	0,02	10		gg / br raw	1,02
R10207	F1/2" x Ø12	0,02	25		gg / br raw	0,98
R10211	F1/2" x Ø14	0,01	25		gg / br raw	1,00
R10200	F3/8" x Ø10	0,01	10		gg / br raw	1,12
R10201	F3/8" x Ø10	0,01	20		cr / chr	0,93
R10202	F3/8" x Ø12	0,01	20		cr / chr	0,95
R102035	F3/8" x Ø14	0,01	10		cr / chr	1,04
R10204	F1/2" x Ø10	0,02	10		cr / chr	1,23
R10206	F1/2" x Ø12	0,01	25		cr / chr	1,20
R10210	F1/2" x Ø14	0,02	10		cr / chr	1,21
R10218	F1" x Ø26	0,03	10		cr / chr	2,83
R10220	F1"1/4 x Ø30	0,06	10		cr / chr	4,41
R10222	F1"1/4 x Ø32	0,06	10		cr / chr	4,34



Dado conico
basso completo di
guarnizioni
Box 1000 pz.

Brass compression nut
with washers
Box 1000 pz.

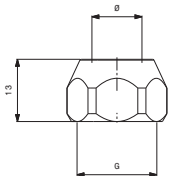

Cod.	Dim.	ø est.	Kg/Pz.	Conf.	Pkg	Fin.	€
R12220	F3/8" x Ø8		0,02	25		cr / chr	1,83
R12221	F3/8" x Ø10	58	0,01	25		cr / chr	1,20
R12222	F3/8" x Ø12	58	0,01	25		cr / chr	1,56
R12223	F1/2" x Ø10	53	0,02	25		cr / chr	2,10
R12224	F1/2" x Ø12	58	0,02	25		cr / chr	1,98
R12225	F1/2" x Ø14	70	0,02	25		cr / chr	2,07



Dado conico alto
scodellino con ranella
fresata, guarnizione
gomma, bussola nylon
Box 1000 pz.

Brass special
compression nut with
brass, rubber and nylon
washers
Box 1000 pz.

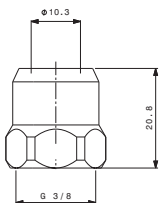

Cod.	Dim.	Kg/Pz.	Conf.	Pkg	Fin.	€
R12235	F3/8" x Ø10	0,02	20		cr / chr	1,47

Guarnizioni / Washers

Ranella piatta in ottone
Box 10000 pz.

Brass washer
Box 10000 pz.

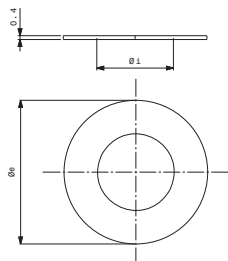

Cod.	Dim.	Kg/Pz.	Conf.	Pkg	€
R12801	3/8" x Ø8	0,00	100		0,06
R12802	3/8" x Ø10	0,00	100		0,08
R12803	3/8" x Ø12	0,00	100		0,21
R12804	1/2" x Ø10	0,00	100		0,09
R12805	1/2" x Ø12	0,00	100		0,10
R12806	1/2" x Ø14	0,00	100		0,11

Guarnizione in gomma
Box 10000 pz.

Rubber washer
Box 10000 pz.

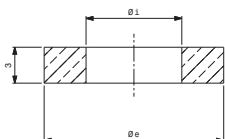

Cod.	Dim.	Kg/Pz.	Conf.	Pkg	€
R15101	3/8" x Ø8	0,00	100		0,04
R15102	3/8" x Ø10	0,00	100		0,06
R15103	3/8" x Ø12	0,00	100		0,08
R15104	1/2" x Ø10	0,00	100		0,08
R15105	1/2" x Ø12	0,00	100		0,10
R15106	1/2" x Ø14	0,00	100		0,10
R15108	3/4" x Ø20	0,00	100		0,05

Ranella conica fresata
in ottone
Box 10000 pz.

Brass milled conical
washer
Box 10000 pz.

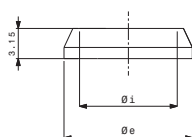

Cod.	Dim.	Kg/Pz.	Conf.	Pkg	€
R12810	3/8" x Ø8	0,00	100		0,52
R12811	3/8" x Ø10	0,00	100		0,20
R12812	3/8" x Ø12	0,00	100		0,29
R12813	1/2" x Ø10	0,00	100		0,37
R12814	1/2" x Ø12	0,00	100		0,39
R12815	1/2" x Ø14	0,00	100		0,49

Guarnizioni / Washers

Guarnizione conica in gomma
Box 10000 pz.

Conical rubber washer
Box 10000 pz.

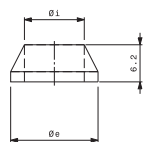

Cod.	Dim.	Kg/Pz.	Conf.	Pkg	€
R15110	3/8" x Ø10	0,00	100		0,07
R15112	1/2" x Ø10	0,00	100		0,10
R15113	1/2" x Ø12	0,00	100		0,05
R15114	1/2" x Ø14	0,00	100		0,06

Bussola speciale completa di ranella fresata, guarnizione in gomma e bussola in nylon
Box 1600 pz.

Special nylon sleeve including brass and rubber washer
Box 1600 pz.

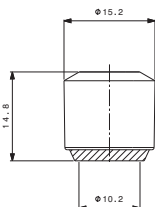

Cod.	Dim.	Kg/Pz.	Conf.	Pkg	€
R152015	3/8" x Ø10	0,00	800		0,43

Guarnizione in fibra
Box 10000 pz.

Fiber washer
Box 10000 pz.

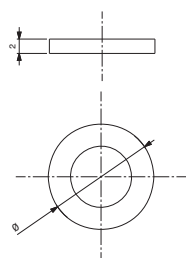

Cod.	Dim.	Kg/Pz.	Conf.	Pkg	€
R15301	3/8"	0,00	100		0,24
R15302	1/2"	0,00	100		0,16
R15303	3/4"	0,00	100		0,21
R15304	1"	0,00	100		0,20
R15307	1"1/4	0,00	100		0,11
R15310	1"1/2	0,00	100		0,13



made in Italy



La tecnologia che semplifica
dal 1961

La serie di tubi, in rame e ottone, per carico e scarico acqua, viene proposta in diverse dimensioni e in spessori che garantiscono un'elevata qualità e resistenza di installazione. A completamento della gamma tubi proponiamo i rosoni in ottone e acciaio inox.

Pipes, made of copper and brass, for water supply and drainage, are offered in various sizes and thicknesses to ensure high quality and installation durability. To complete the pipes range, we offer brass and stainless steel cover plate.

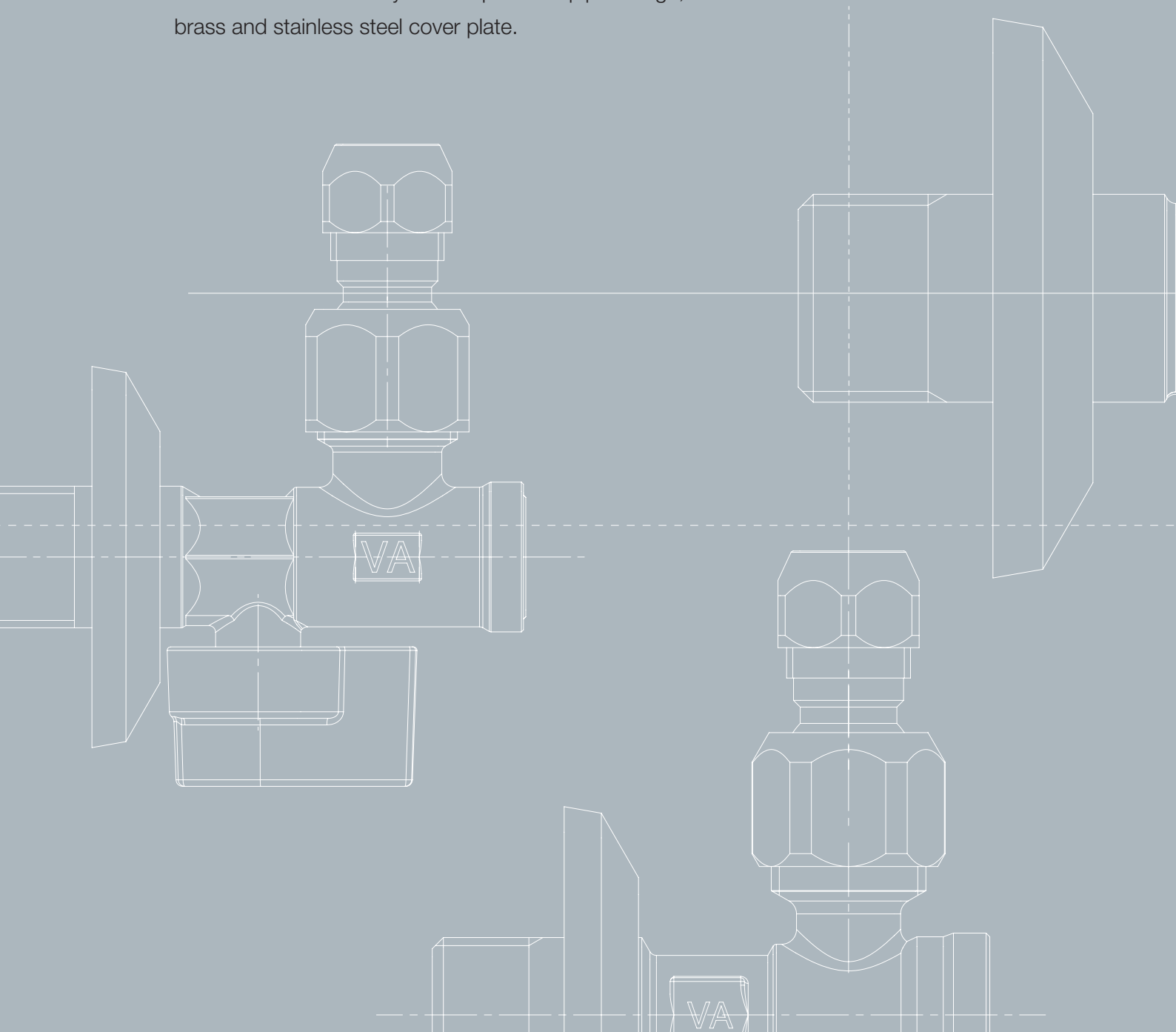

Tubi rame

Copper pipes

Tubi ottone

Brass pipes

Rosoni

Cover plates

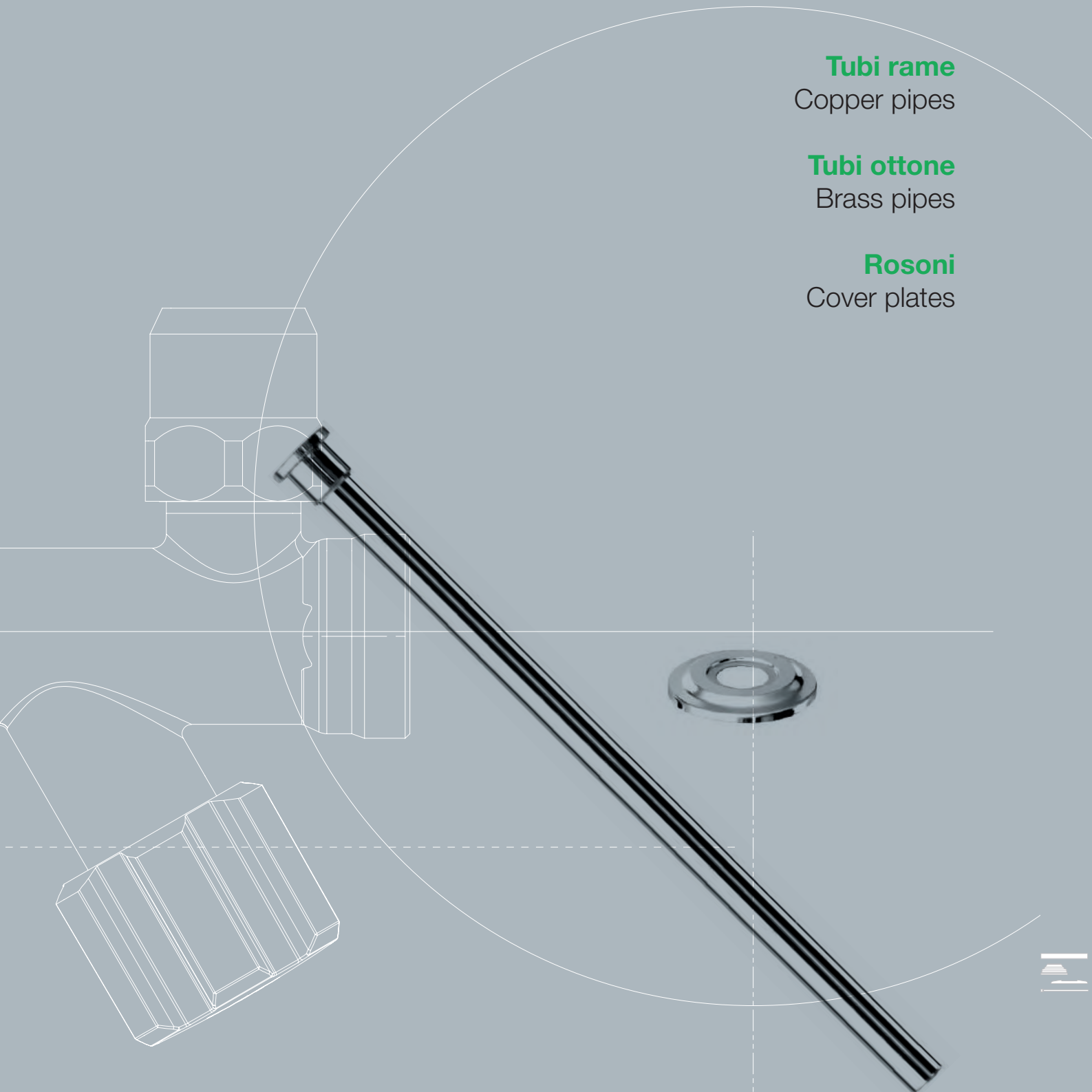

Tubi rame / Copper pipes

Tubo pieghevole in rame, flangia tornita e saldata, cromato
Box 250 pz.

Copper tube, flange soldered and nut, chrome plated
Box 250 pz.

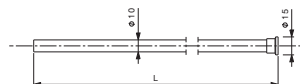

Cod.	Dim.	ø mm	L. mm	Kg/Pz.	Conf.	Pkg	Fin.	€
M365304	Fl. 3/8"	10	300	0,05	10		cr / chr	4,94
M365306	Fl. 3/8"	10	400	0,07	10		cr / chr	6,47
M365308	Fl. 3/8"	10	500	0,09	10		cr / chr	7,27
M365313	Fl. 3/8"	10	1000	0,17	10		cr / chr	13,54
M365604	Fl. 1/2"	10	300	0,06	10		cr / chr	6,08
M365606	Fl. 1/2"	10	400	0,08	10		cr / chr	6,57
M365608	Fl. 1/2"	10	500	0,10	10		cr / chr	6,91
M365609	Fl. 1/2"	10	600	0,12	10		cr / chr	7,26
M365613	Fl. 1/2"	10	1000	0,19	10		cr / chr	13,82

Tubo pieghevole in rame, flangia tornita e saldata, con dado, cromato
Box 250 pz.

Copper tube, flange soldered and nut, chrome plated
Box 250 pz.

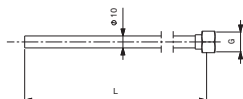

Cod.	Dim.	ø mm	L. mm	Kg/Pz.	Conf.	Pkg	Fin.	€
M382004	Fl. 3/8"	10	300	0,04	10		cr / chr	5,95
M382006	Fl. 3/8"	10	400	0,06	10		cr / chr	7,48
M382008	Fl. 3/8"	10	500	0,10	10		cr / chr	8,23
M382013	Fl. 3/8"	10	1000	0,20	10		cr / chr	14,43
M382104	Fl. 1/2"	10	300	0,06	10		cr / chr	7,32
M382106	Fl. 1/2"	10	400	0,08	10		cr / chr	7,75
M382108	Fl. 1/2"	10	500	0,10	10		cr / chr	8,09
M382109	Fl. 1/2"	10	600	0,12	10		cr / chr	8,42
M382113	Fl. 1/2"	10	1000	0,18	10		cr / chr	14,87

Tubo pieghevole in rame, flangia tornita e saldata, dado, attacchi MF, nipples H35, cromato
Box 250 pz.

Copper tube with soldered flange, nipple with conical nut, connections MF, chrome plated
Box 250 pz.

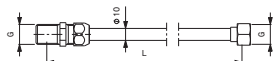

Cod.	Dim.	ø mm	L. mm	Kg/Pz.	Conf.	Pkg	Fin.	€
M381304	3/8" x 3/8"	10	300	0,08	10		cr / chr	9,43
M381306	3/8" x 3/8"	10	400	0,10	10		cr / chr	10,95
M381308	3/8" x 3/8"	10	500	0,12	10		cr / chr	11,76
M381313	3/8" x 3/8"	10	1000	0,18	10		cr / chr	18,03
M381504	1/2" x 3/8"	10	300	0,08	10		cr / chr	9,97
M381506	1/2" x 3/8"	10	400	0,10	10		cr / chr	11,42
M381508	1/2" x 3/8"	10	500	0,12	10		cr / chr	12,29
M381513	1/2" x 3/8"	10	1000	0,18	10		cr / chr	18,57
M381604	1/2" x 1/2"	10	300	0,08	10		cr / chr	11,21
M381606	1/2" x 1/2"	10	400	0,10	10		cr / chr	11,77
M381608	1/2" x 1/2"	10	500	0,12	10		cr / chr	12,04
M381609	1/2" x 1/2"	10	600	0,14	10		cr / chr	12,40
M381613	1/2" x 1/2"	10	1000	0,16	10		cr / chr	19,02

Tubi rame / Copper pipes

Tubo pieghevole
in rame, flangia
stampata, cromato
Box 250 pz.



Copper tube, flange
pressed, chrome plated
Box 250 pz.

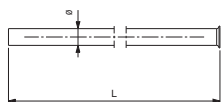

Cod.	Dim.	ø mm	L. mm	Kg/Pz.	Conf.	Pkg	Fin.	€
M361304	Fl. 3/8"	10	300	0,05	10		cr / chr	4,61
M361306	Fl. 3/8"	10	400	0,08	10		cr / chr	5,49
M361308	Fl. 3/8"	10	500	0,09	10		cr / chr	6,38
M361313	Fl. 3/8"	10	1000	0,19	10		cr / chr	12,77
M361604	Fl. 1/2"	10	300	0,06	10		cr / chr	4,64
M361605	Fl. 1/2"	10	350	0,07	10		cr / chr	5,28
M361606	Fl. 1/2"	10	400	0,08	10		cr / chr	5,81
M361608	Fl. 1/2"	10	500	0,10	10		cr / chr	6,35
M361613	Fl. 1/2"	10	1000	0,20	10		cr / chr	13,47
M362604	Fl. 1/2"	12	300	0,07	10		cr / chr	5,85
M362606	Fl. 1/2"	12	400	0,09	10		cr / chr	6,97
M362608	Fl. 1/2"	12	500	0,12	10		cr / chr	9,14
M360621	Fl. 1/2"	14	300	0,08	10		cr / chr	6,51
M360623	Fl. 1/2"	14	400	0,11	10		cr / chr	6,74

Tubo pieghevole in
rame, due flange
stampate da 1/2" e
3/8", cromato
Box 250 pz.



Copper tube with two
flanges 1/2" and 3/8",
chrome plated
Box 250 pz.

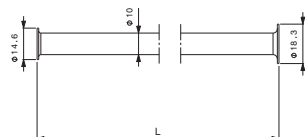

Cod.	ø mm	L. mm	Kg/Pz.	Conf.	Pkg	Fin.	€
M371404	10	300	0,06	10		cr / chr	5,10
M371406	10	400	0,08	10		cr / chr	6,62
M371408	10	500	0,10	10		cr / chr	7,58
M371409	10	600	0,11	10		cr / chr	8,28
M371410	10	700	0,13	10		cr / chr	10,15
M371411	10	800	0,15	10		cr / chr	10,60
M371413	10	1000	0,19	10		cr / chr	13,84

Tubetto pieghevole
in rame, due flange
stampate da 1/2" con
dadi, cromato
Box 100 pz.



Copper tube with two
flanges 1/2" and nuts,
chrome plated
Box 100 pz.

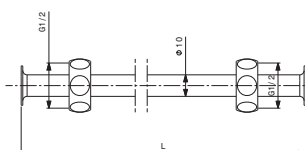

Cod.	ø mm	L. mm	Kg/Pz.	Conf.	Pkg	Fin.	€
M272704	10	300	0,08	10		cr / chr	10,32
M272706	10	400	0,10	10		cr / chr	11,14
M272708	10	500	0,12	10		cr / chr	11,86
M272709	10	600	0,14	10		cr / chr	12,25
M272711	10	800	0,16	10		cr / chr	14,09
M272713	10	1000	0,19	10		cr / chr	16,60

Tubi rame / Copper pipes



Squadra di raccordo in tubo rame
Box 100 pz.

Bent copper tube
Box 100 pz.

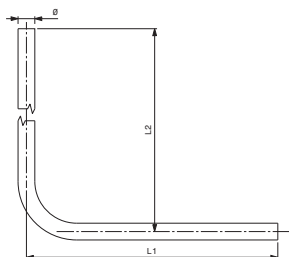

Cod.	ø mm	L. mm	Kg/Pz.	Conf.	Pkg	Fin.	€
M301003	10	150x250	0,07	5		cr / chr	5,73
M302006	12	150x250	0,09	5		cr / chr	6,40
M302008	12	200x300	0,11	5		cr / chr	7,67
M304010	14	150x250	0,11	5		cr / chr	7,07
M304013	14	200x300	0,13	5		cr / chr	10,86



Squadra di raccordo in tubo rame, nipples giallo 1/2", rosone ottone, dado 1/2", confezionati a coppie
Box 100 pz.

Bent copper tube with 1/2" raw nipple, brass cover plate and 1/2" nut, packed 2 pieces in a bag
Box 100 pz.

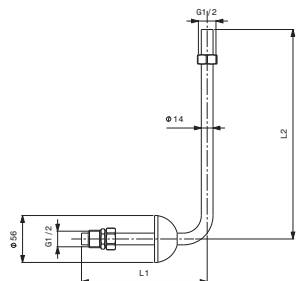

Cod.	ø mm	L. mm	Kg/Pz.	Conf.	Pkg	Fin.	€
M312606C	12	150x250	0,18	2		cr / chr	13,92
M312608C	12	200x300	0,19	2		cr / chr	15,61
M314610C	14	150x250	0,18	2		cr / chr	13,24
M314613C	14	200x300	0,40	2		cr / chr	17,83
M314617C	14	250x400	0,25	2		cr / chr	17,85
M314618C	14	250x500	0,27	2		cr / chr	19,80



Prolunga in tubo di rame, dado conico basso
Box 100 pz.

Copper tube extension with soldered nipple and compression nut
Box 100 pz.

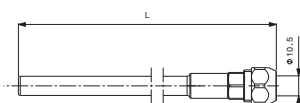

Cod.	ø mm	L. mm	Kg/Pz.	Conf.	Pkg	Fin.	€
M12304	10	300	0,08	10		cr / chr	7,18
M12306	10	400	0,10	10		cr / chr	8,32
M12308	10	500	0,11	10		cr / chr	8,88

Tubi rame / Copper pipes

Estensione tubo rame per radiatori, uscita maschio 1/2", lucidato
Box 100 pz.



Cod.	ø mm	L. mm	Kg/Pz.	Conf.	Pkg	Fin.	€
M1214160	14	1/2"x160	0,07	1		cr / chr	7,93

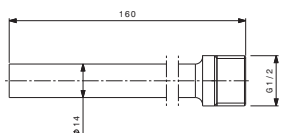

Copper tube extension for radiator, male outlet 1/2", polished
Box 100 pz.



Tubetto in rame con raccordo maschio M10x1, OR
Box 200 pz.





Cod.	ø mm	L. mm	Kg/Pz.	Conf.	Pkg	Fin.	€
K04105	10	300	0,06	10		cr / chr	5,45
K04106	10	350	0,06	10		cr / chr	4,79
K04107	10	500	0,09	10		cr / chr	6,85

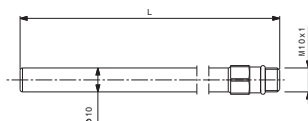

Copper tube with M10x1 soldered nipple and o-ring
Box 200 pz.



Tubo di rame in rotolo
Box 20 pz.

Cod.	ø mm	L. mm	Kg/Pz.	Conf.	Pkg	Fin.	€
M04268	8	5000	0,72	1		cr / chr	51,63
M04269	10	5000	0,96	1		cr / chr	59,15
M04270	12	5000	1,04	1		cr / chr	80,90
M04278	14	5000	1,15	1		cr / chr	98,83



Copper tube in roll
Box 20 pz.

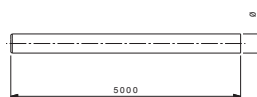

Tubi rame / Copper pipes

Tubo pieghevole di
rame
Box 10 pz.

Copper tube
Box 10 pz.

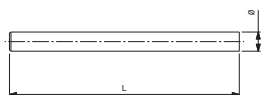

Cod.	ø mm	L. mm	Kg/Pz.	Conf.	Pkg	Fin.	€
M352018	10	120	0,03	10		cr / chr	1,74
M351002	10	200	0,03	10		cr / chr	2,61
M351004	10	300	0,06	10		cr / chr	4,08
M351006	10	400	0,07	10		cr / chr	4,82
M351008	10	500	0,09	10		cr / chr	6,23
M351009	10	600	0,11	10		cr / chr	7,19
M351011	10	800	0,15	10		cr / chr	11,29
M04263	10	1000	0,19	10		cr / chr	11,96
M04264	10	1500	0,27	10		cr / chr	18,46
M04265	10	2000	0,65	10		cr / chr	36,30
M04266	12	1000	0,23	10		cr / chr	15,01
M04271	12	2000	0,44	10		cr / chr	43,06
M04272	14	1000	0,27	10		cr / chr	21,82
M04274	14	2000	0,52	5		cr / chr	48,66
M04282	15	1000	0,30	10		cr / chr	19,30

Tubo pieghevole in
rame per scarico
Box 100 pz.

Drain flexible copper
tube
Box 100 pz.

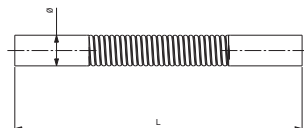

Cod.	ø mm	L. mm	Kg/Pz.	Conf.	Pkg	Fin.	€
M04161	26	250	0,08	10		cr / chr	8,32
M04162	26	300	0,09	10		cr / chr	9,17
M04164	26	400	0,11	10		cr / chr	15,96
M04128	30	250	0,09	10		cr / chr	11,98
M04129	30	300	0,10	10		cr / chr	12,75
M04131	30	400	0,15	10		cr / chr	16,72
M04133	32	250	0,10	10		cr / chr	12,21
M04134	32	300	0,11	10		cr / chr	13,34
M04136	32	400	0,16	5		cr / chr	19,21

Tubi ottone / Brass pipes



Tubo a squadra per scarico, ottone, spessore tubo 0,5 mm
Box 50 pz.

Brass drain elbow tube without flange
Box 50 pz.

Cod.	ø mm	L. mm	Kg/Pz.	Conf.	Pkg	Fin.	€	
I04222	30	150x250	0,10	5		cr / chr	8,84	
I04223	30	200x300	0,16	5		cr / chr	11,01	
I04218	30	300x300	0,20	5		cr / chr	18,08	
I04225	32	200x300	0,20	2		cr / chr	13,19	
I04219		curva stretta Sharp curve	30	150x250	0,13	5		9,37
I04239		curva stretta Sharp curve	30	200x300	0,16	5		12,20

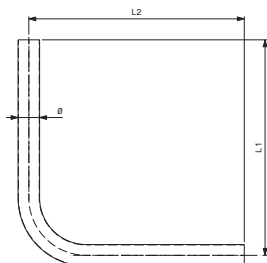

Tubo a squadra in ottone, per scarico a terra lavabo, spessore 0,5 mm
Box 10 pz.

Lavatory drain elbow tube
Box 10 pz.

Cod.	ø mm	L. mm	Kg/Pz.	Conf.	Pkg	Fin.	€
I04230	32	220x680	0,35	1		cr / chr	30,40

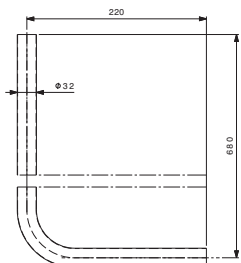

Tubo a squadra per scarico, ottone, con flangia, spessore tubo 0,4 mm
Box 100 pz.

Drain elbow tube with flange
Box 100 pz.

Cod.	ø mm	L. mm	Kg/Pz.	Conf.	Pkg	Fin.	€
I04115	30	55x300	0,12	5		cr / chr	9,20
I04117	32	55x300	0,14	5		cr / chr	10,68

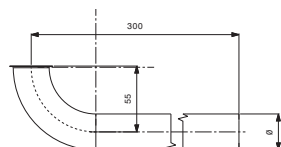

Tubi ottone / Brass pipes

Tubo diritto in ottone,
spessore tubo 0,5 mm
Box 100 pz.

Drain straight tube
Box 100 pz.

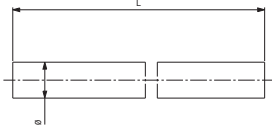

Cod.	ø mm	L. mm	Kg/Pz.	Conf.	Pkg	Fin.	€
I04181	26	200	0,05	10		cr / chr	4,73
I04182	26	250	0,09	10		cr / chr	5,41
I04183	26	300	0,11	5		cr / chr	6,29
I04206	26	1000	0,35	5		cr / chr	21,66
I04186	30	200	0,08	10		cr / chr	4,95
I04187	30	250	0,11	10		cr / chr	6,00
I04188	30	300	0,13	10		cr / chr	6,89
I041672	30	400	0,18	5		cr / chr	11,51
I04208	30	1000	0,42	5		cr / chr	24,63
I04191	32	200	0,08	5		cr / chr	5,32
I04192	32	250	0,11	10		cr / chr	6,34
I04193	32	300	0,13	10		cr / chr	7,46
I041674	32	400	0,17	5		cr / chr	10,43
I04210	32	1000	0,43	5		cr / chr	25,67
I04201	40	300	0,14	5		cr / chr	10,10
I04213	40	1000	0,49	5		cr / chr	33,07

Tubo diritto in ottone
con flangia, spessore
tubo 0,5 mm
Box 100 pz.

Drain straight tube with
flange
Box 100 pz.

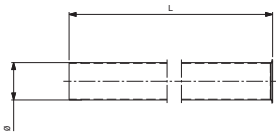

Cod.	Dim.	ø mm	L. mm	Kg/Pz.	Conf.	Pkg	Fin.	€
I04149	Fl. 1"	26	200	0,07	10		cr / chr	4,52
I04150	Fl. 1"	26	250	0,09	10		cr / chr	5,45
I04151	Fl. 1"	26	300	0,11	10		cr / chr	6,39
I04351	Fl. 1"1/4	26	250	0,09	10		cr / chr	6,48
I04352	Fl. 1"1/4	26	300	0,11	10		cr / chr	7,48
I04153	Fl. 1"1/4	30	200	0,09	5		cr / chr	5,03
I04154	Fl. 1"1/4	30	250	0,11	10		cr / chr	6,16
I04155	Fl. 1"1/4	30	300	0,13	10		cr / chr	7,09
I04157	Fl. 1"1/4	32	200	0,09	10		cr / chr	5,26
I04158	Fl. 1"1/4	32	250	0,11	10		cr / chr	6,35
I04159	Fl. 1"1/4	32	300	0,13	10		cr / chr	7,37
I04162	Fl. 1"1/2	40	300	0,13	5		cr / chr	9,37
I04351D	Fl. 1"1/4 con dado Fl. 1"1/4 with nut	26	250	0,15	1		cr / chr	11,36
I04352D	Fl. 1"1/4 con dado Fl. 1"1/4 with nut	26	300	0,17	1		cr / chr	12,23

Tubo per adduzione
WC, rosone pesante
Box 100 pz.

WC tube with heavy
cover plate
Box 100 pz.

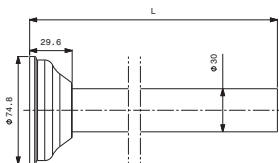

Cod.	ø mm	L. mm	Kg/Pz.	Conf.	Pkg	Fin.	€
I04251	30	200	0,09	10		cr / chr	6,50
I04252	30	250	0,11	10		cr / chr	7,56
I04253	30	300	0,13	10		cr / chr	8,49

Tubi ottone / Brass pipes



Tubo eccentrico in ottone per scarico, spessore tubo 0,7 mm, spostamento 20 mm
Box 100 pz.

Eccentric brass tube for drain shift 20 mm
Box 100 pz.

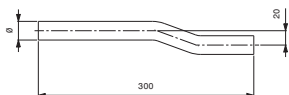

Cod.	ø mm	L. mm	Kg/Pz.	Conf.	Pkg	Fin.	€
I04244	26	300	0,15	10		cr / chr	13,89
I04245	30	300	0,16	10		cr / chr	10,97
I04246	32	300	0,19	10		cr / chr	11,75



Tubo a 45° senza flangia, in ottone, spessore tubo 0,4 mm
Box 50 pz.

45° drain tube
Box 50 pz.

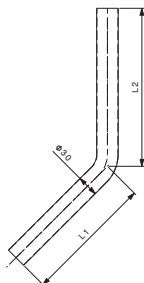

Cod.	ø mm	L. mm	Kg/Pz.	Conf.	Pkg	Fin.	€
I04101	30	140x160	0,11	5		cr / chr	7,72
I04096	30	180x220	0,15	5		cr / chr	10,02



Tubo a 45° senza flangia, in ottone, con rosone foro ovale, spessore tubo 0,4 mm
Box 100 pz.

45° drain tube with oval hole brass cover plate
Box 100 pz.

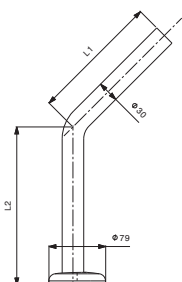

Cod.	ø mm	L. mm	Kg/Pz.	Conf.	Pkg	Fin.	€
I04103	30	140x160	0,13	5		cr / chr	9,60
I04118	30	180x220	0,17	5		cr / chr	11,91

Tubi ottone / Brass pipes



Prolunga per tubi in ottone, con o-ring
Box 100 pz.

Tubes extension with o-ring
Box 100 pz.



Cod.	ø mm	L. mm	Kg/Pz.	Conf.	Pkg	Fin.	€
I04290	26	130	0,03	10		cr / chr	4,41
I04291	30	130	0,04	10		cr / chr	4,93
I04292	32	130	0,04	10		cr / chr	4,97



Giunzione per tubi in ottone, due o-ring
Box 100 pz.

Tubes connection with two o-rings
Box 100 pz.

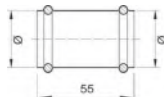

Cod.	ø mm	L. mm	Kg/Pz.	Conf.	Pkg	Fin.	€
I04280	26	55	0,03	10		cr / chr	4,56
I04281	30	55	0,03	10		cr / chr	4,84
I04282	32	55	0,03	10		cr / chr	5,18



Giunzione ridotta, due o-ring
Box 100 pz.

Reduced connection with two o-rings
Box 100 pz.

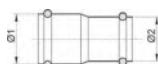

Cod.	ø mm	ø est.	Kg/Pz.	Conf.	Pkg	Fin.	€
I04270	26	32	0,03	10		cr / chr	5,30
I04272	32	40	0,05	10		cr / chr	5,54
I04271	30	32	0,04	10		cr / chr	5,85

Tubi ottone / Brass pipes



Tubo ottone per attacco scarico lavatrice, con flangia
Box 100 pz.

Brass drain straight tube for washing machine with flange and nut
Box 100 pz.

Cod.	ø mm	L. mm	Kg/Pz.	Conf.	Pkg	Fin.	€
I04301	32	200	0,15	10		cr / chr	25,80



Tubo ottone con aeratore
Box 50 pz.



Brass tube with aerator
Box 50 pz.

Cod.	ø mm	L. mm	Kg/Pz.	Conf.	Pkg	Fin.	€
I04322	32	250	0,23	10		cr / chr	29,93



Morsetto gomma per scarico WC
Box 100 pz.

Rubber buckle for tubes
Box 100 pz.

Cod.	ø mm	ø est.	Kg/Pz.	Conf.	Pkg	€
K07136	30	50	0,04	50		1,47
K07137	30	65	0,05	50		1,43

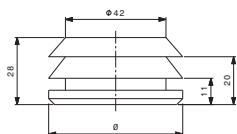

Rosoni / Cover plates

Rosone normale inox
Box 500 pz.

Stainless steel cover
plate
Box 500 pz.

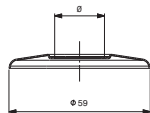

Cod.	Dim.	ø est.	Kg/Pz.	Conf.	Pkg	Fin.	€
R50101	3/8"	70	0,01	50		inox / steel	0,26
R50102	1/2"	70	0,01	50		inox / steel	0,24

Rosone normale
ottone
Box 1000 pz.

Brass cover plate
Box 1000 pz.

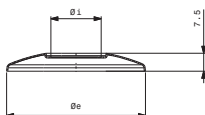

Cod.	Dim.	ø mm	ø est.	Kg/Pz.	Conf.	Pkg	Fin.	€
R50103	3/8"		70	0,01	100		cr / chr	0,76
R50104	1/2"	18		0,01	100		cr / chr	0,78
R50104/70	1/2"	20		0,01	50		cr / chr	1,40
R50105	3/4"	26		0,01	50		cr / chr	1,40
R50106	1"	32		0,01	50		cr / chr	1,79

Rosone scorrevole
ottone con ghiera
Box 500 pz.

Sliding brass cover plate
with nylon
Box 500 pz.

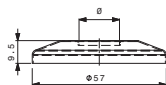

Cod.	Dim.	Kg/Pz.	Conf.	Pkg	Fin.	€
R50128	3/8"	0,01	25		cr / chr	0,97
R50129	1/2"	0,01	25		cr / chr	1,83

Rosoni / Cover plates



Rosone scorrevole
inox con ghiera
Box 500 pz.

Sliding stainless steel
cover plate with nylon
Box 500 pz.

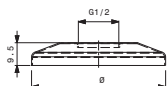

Cod.	Dim.	ø est.	Kg/Pz.	Conf.	Pkg	Fin.	€
R50131	1/2"	57	0,01	50		inox / steel	0,30
R50132	1/2"	57	0,01	50		inox / steel	0,36
R501325	1/2"		0,02	25		inox / steel	0,67



Rosone apribile,
ottone
Box 500 pz.

Openable brass cover
plate
Box 500 pz.

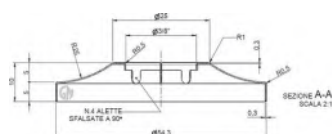

Cod.	Dim.	ø mm	ø est.	Kg/Pz.	Conf.	Pkg	Fin.	€
R50108	3/8"	10		0,01	50		cr / chr	1,90
R50109	1/2"	12		0,01	50		cr / chr	1,90
R50110	3/4"	14		0,01	50		cr / chr	2,44
R50111	1"	16		0,01	50		cr / chr	2,44
R50112	1"1/4		58	0,01	25		cr / chr	2,84
R50181			58	0,01	25		cr / chr	2,04
R50182		26	110	0,01	25		cr / chr	2,04
R50183		30	110	0,00	50		cr / chr	2,06
R50184		32	110	0,01	50		cr / chr	2,14



Rosone filettato,
ottone
Box 250 pz.

Heavy threaded cover
plate
Box 250 pz.

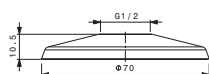

Cod.	Dim.	ø mm	Kg/Pz.	Conf.	Pkg	Fin.	€
R50125	1/2"	42	0,03	25		cr / chr	2,92

Rosoni / Cover plates



Rosone inox con foro esagonale
Box 250 pz.

Cover plate with hexagonal hole
Box 250 pz.

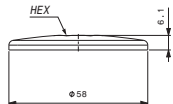

Cod.	Dim.	ø mm	ø est.	Kg/Pz.	Conf.	Pkg	Fin.	€
R50133	3/8"	30	78	0,01	25		inox / steel	0,34
R50134	1/2"	30	95	0,01	25		inox / steel	0,28



Rosone scorrevole
ottone LINEA cromato
Box 50 pz.

Sliding cover plate
LINEA brass, chrome plated
Box 50 pz.

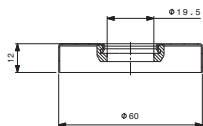

Cod.	Dim.	Kg/Pz.	Conf.	Pkg	Fin.	€
R50204	1/2"	0,02	1		cr / chr	2,57



Rosone scorrevole
ottone LINEA
QUADRO cromato
Box 50 pz.

Sliding cover plate
LINEA QUADRO brass,
chrome plated
Box 50 pz.

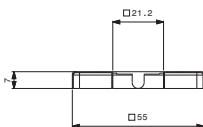

Cod.	Dim.	ø mm	ø est.	Kg/Pz.	Conf.	Pkg	Fin.	€
R50214	1/2"	40	78	0,01	1		cr / chr	6,28

Rosoni / Cover plates

Rosone ottone per
sottolavabo
Box 750 pz.



Brass cover plate
Box 750 pz.

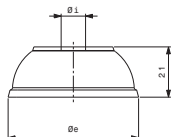

Cod.	ø mm	ø est.	Kg/Pz.	Conf.	Pkg	Fin.	€
R50119	14	57	0,01	50		cr / chr	1,12
R50120		53	0,01	50		cr / chr	1,12
R50121		53	0,01	50		cr / chr	1,12

Rosone inox per
sottolavabo
Box 500 pz.



Stainless steel cover
plate
Box 500 pz.

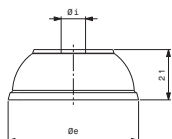

Cod.	ø est.	Kg/Pz.	Conf.	Pkg	Fin.	€
R50116	53	0,02	50		inox / steel	0,56
R50117	53	0,01	50		inox / steel	0,48
R50118	57	0,01	50		inox / steel	0,43

Rosone gigante in
ottone
Box 50 pz.



Brass cover plate
Box 50 pz.

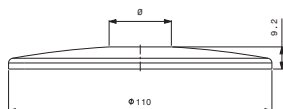

Cod.	ø mm	ø est.	Kg/Pz.	Conf.	Pkg	Fin.	€
R50169	30	110	0,07	1		cr / chr	4,69
R50170	26	75	0,06	1		cr / chr	4,69
R50171	30	75	0,07	1		cr / chr	4,69

Rosoni / Cover plates

Rosone con foro ovale
Box 250 pz.



Brass cover plate with
oval hole
Box 250 pz.

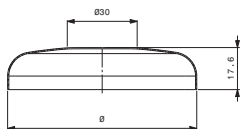

Cod.		ø mm	ø est.	Kg/Pz.	Conf.	Pkg	Fin.	€
R50145		32	75	0,02	25		cr / chr	1,91
R50172	Gigante Giant			0,03	1		cr / chr	7,76
R50173	Gigante Giant	30	70	0,06	10		cr / chr	8,51

Rosone inox con foro
ovale
Box 500 pz.



Stainless steel cover
plate with oval hole
Box 500 pz.

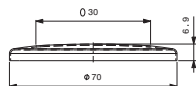

Cod.		ø mm	ø est.	Kg/Pz.	Conf.	Pkg	Fin.	€
R50146		10	55	0,01	50		cr / chr	0,81

Rosone conico, per
tubo adduzione WC
Box 500 pz.



Conical cover plate for
drain tube
Box 500 pz.

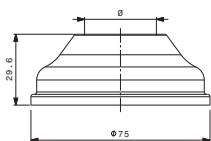

Cod.		ø mm	ø est.	Kg/Pz.	Conf.	Pkg	Fin.	€
R50149		26	78	0,02	50		cr / chr	1,54
R50150		30	78	0,02	50		cr / chr	1,54
R50151		32	78	0,02	50		cr / chr	1,54

Rosoni / Cover plates



Rosone conico, per tubo adduzione WC
Box 250 pz.

Conical cover plate for drain tube
Box 250 pz.

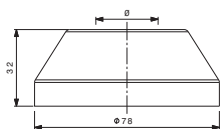

Cod.	ø mm	ø est.	Kg/Pz.	Conf.	Pkg	Fin.	€
R50154	12	55	0,03	25		cr / chr	2,23
R50155	14	55	0,03	25		cr / chr	2,71
R50156	10	57	0,03	25		cr / chr	2,53
R50158	12	57	0,03	25		cr / chr	2,23



Rosone a scatola
Box 250 pz.

High cover plate
Box 250 pz.

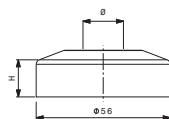

Cod.	Dim.	ø mm	ø est.	Kg/Pz.	Conf.	Pkg	Fin.	€
R50164	3/8" x H15		65	0,02	25		cr / chr	1,55
R50165	1/2" x H15		77	0,02	25		cr / chr	1,45
R50166	1/2" x H20			0,02	15		cr / chr	1,68
R50167	1/2" x H25	14	45	0,02	10		cr / chr	2,35



Rosone ottone Ø45
mm per tubo Ø14 mm
Box 50 pz.

Brass cover plate Ø45
mm for copper tube
Ø14 mm
Box 50 pz.

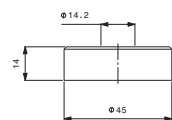

Cod.	Kg/Pz.	Conf.	Pkg	Fin.	€
R50192	0,09	1		cr / chr	14,60

made in Italy



ALBERTONI

*La tecnologia che semplifica
dal 1961*

**La serie di flessibili viene proposta per l'utilizzo e
l'allacciamento idrico sanitario, con tubo interno in gomma
EPDM atossica e maglia in acciaio.**

Flexhoses are suitable for the use with drinking water. Core it is made with approved EPDM rubber and net outside is in stainless steel.

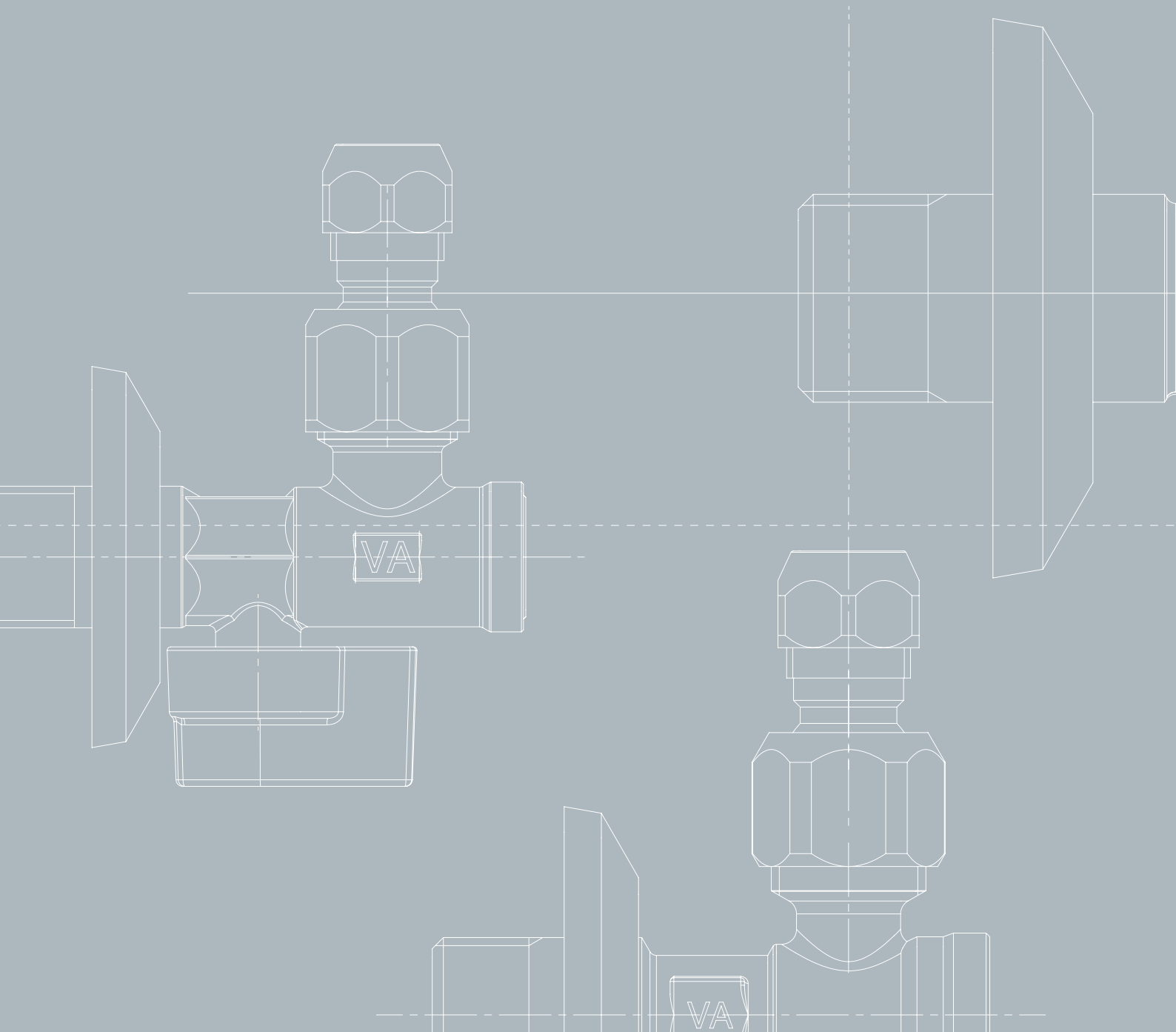

Flessibili inox

Stainless steel flex hoses

Flessibili antivibranti Inox

Vibration dumping inox hoses

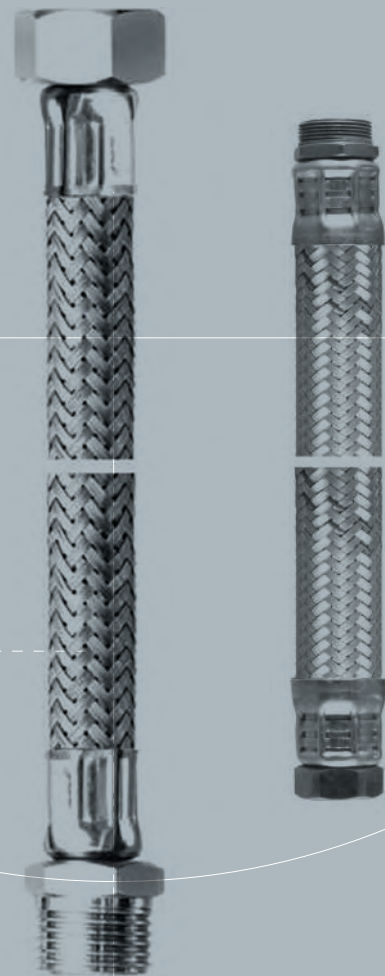
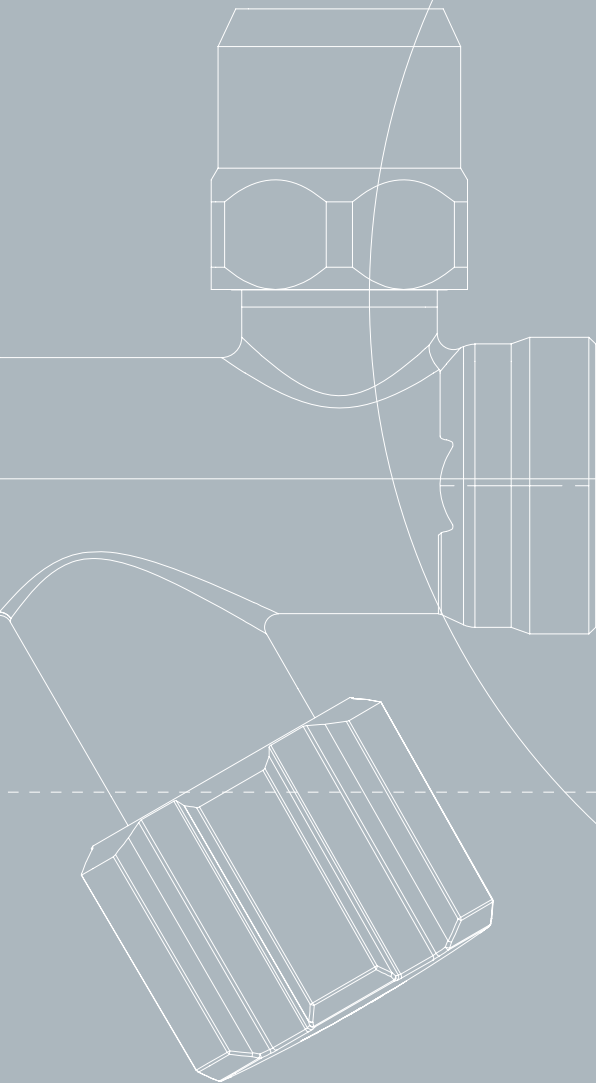

Flessibili inox / Stainless steel flex hoses



Flessibile in treccia di acciaio inox, maschio femmina, DN8 Ø 14 mm
Box 100 pz.

Hose with stainless steel braiding, male female, DN8 Ø 14 mm
Box 100 pz.

Cod.	Dim.	L. mm	Kg/Pz.	Conf.	Pkg	Fin.	€
P600302	M3/8" x F3/8"	200	0,07	10		inox / steel	3,21
P600303	M3/8" x F3/8"	250	0,07	10		inox / steel	3,32
P600304	M3/8" x F3/8"	300	0,08	10		inox / steel	3,43
P600306	M3/8" x F3/8"	400	0,09	10		inox / steel	3,68
P600307	M3/8" x F3/8"	500	0,11	10		inox / steel	3,94
P600602	M1/2" x F1/2"	200	0,07	10		inox / steel	3,83
P600603	M1/2" x F1/2"	250	0,07	10		inox / steel	3,94
P600604	M1/2" x F1/2"	300	0,08	10		inox / steel	4,05
P600606	M1/2" x F1/2"	400	0,09	10		inox / steel	4,30
P600607	M1/2" x F1/2"	500	0,11	10		inox / steel	4,52



Flessibile in treccia di acciaio inox, femmina femmina, DN8 Ø 14 mm
Box 100 pz.

Hose with stainless steel braiding, female female, DN8 Ø 14 mm
Box 100 pz.

Cod.	Dim.	L. mm	Kg/Pz.	Conf.	Pkg	Fin.	€
P610302	F3/8" x F3/8"	200	0,07	10		inox / steel	2,77
P610303	F3/8" x F3/8"	250	0,08	10		inox / steel	2,88
P610304	F3/8" x F3/8"	300	0,08	10		inox / steel	2,99
P610306	F3/8" x F3/8"	400	0,09	10		inox / steel	3,25
P610307	F3/8" x F3/8"	500	0,11	10		inox / steel	3,47
P610402	F1/2" x F3/8"	200	0,07	10		inox / steel	3,10
P610403	F1/2" x F3/8"	250	0,08	10		inox / steel	3,14
P610404	F1/2" x F3/8"	300	0,08	10		inox / steel	3,25
P610406	F1/2" x F3/8"	400	0,09	10		inox / steel	3,47
P610407	F1/2" x F3/8"	500	0,11	10		inox / steel	3,72
P610502	F1/2" x F1/2"	200	0,07	10		inox / steel	3,25
P610503	F1/2" x F1/2"	250	0,08	10		inox / steel	3,36
P610504	F1/2" x F1/2"	300	0,08	10		inox / steel	3,47
P610506	F1/2" x F1/2"	400	0,09	10		inox / steel	3,72
P610507	F1/2" x F1/2"	500	0,11	10		inox / steel	3,94

Flessibili inox / Stainless steel flex hoses



Flessibile in treccia di acciaio inox, maschio femmina, DN10 Ø 14 mm
Box 100 pz.

Hose with stainless steel braiding, male female, DN10 Ø 14 mm
Box 100 pz.

Cod.	Dim.	L. mm	Kg/Pz.	Conf.	Pkg	Fin.	€
P110301	M3/8" x F3/8"	150	0,07	10		inox / steel	3,79
P110302	M3/8" x F3/8"	200	0,08	10		inox / steel	3,95
P110303	M3/8" x F3/8"	250	0,08	10		inox / steel	4,08
P110304	M3/8" x F3/8"	300	0,09	10		inox / steel	4,36
P110305	M3/8" x F3/8"	350	0,10	10		inox / steel	4,51
P110306	M3/8" x F3/8"	400	0,11	10		inox / steel	4,67
P110308	M3/8" x F3/8"	500	0,12	10		inox / steel	4,99
P110309	M3/8" x F3/8"	600	0,13	10		inox / steel	5,41
P110401	M3/8" x F1/2"	150	0,07	10		inox / steel	3,91
P110402	M3/8" x F1/2"	200	0,08	10		inox / steel	4,28
P110403	M3/8" x F1/2"	250	0,09	10		inox / steel	4,51
P110404	M3/8" x F1/2"	300	0,10	10		inox / steel	4,71
P110405	M3/8" x F1/2"	350	0,11	10		inox / steel	4,80
P110406	M3/8" x F1/2"	400	0,10	10		inox / steel	5,01
P110408	M3/8" x F1/2"	500	0,14	10		inox / steel	5,39
P110501	M1/2" x F3/8"	150	0,08	10		inox / steel	4,05
P110502	M1/2" x F3/8"	200	0,08	10		inox / steel	4,33
P110503	M1/2" x F3/8"	250	0,09	10		inox / steel	4,54
P110504	M1/2" x F3/8"	300	0,10	10		inox / steel	4,75
P110505	M1/2" x F3/8"	350	0,11	10		inox / steel	4,61
P110506	M1/2" x F3/8"	400	0,11	10		inox / steel	5,14
P110508	M1/2" x F3/8"	500	0,13	10		inox / steel	5,65
P110601	M1/2" x F1/2"	150	0,08	10		inox / steel	4,26
P110602	M1/2" x F1/2"	200	0,09	10		inox / steel	4,73
P110603	M1/2" x F1/2"	250	0,10	10		inox / steel	4,99
P110604	M1/2" x F1/2"	300	0,11	10		inox / steel	5,27
P110605	M1/2" x F1/2"	350	0,11	10		inox / steel	5,55
P110606	M1/2" x F1/2"	400	0,12	10		inox / steel	5,80
P110608	M1/2" x F1/2"	500	0,13	10		inox / steel	6,19
P110609	M1/2" x F1/2"	600	0,15	10		inox / steel	6,59
P110611	M1/2" x F1/2"	800	0,18	10		inox / steel	8,36
P110613	M1/2" x F1/2"	1000	0,21	10		inox / steel	11,23
P110618	M1/2" x F1/2"	1500	0,29	10		inox / steel	13,02

Flessibili inox / Stainless steel flex hoses



Flessibile in treccia di acciaio inox, femmina femmina, DN10 Ø 14 mm
Box 100 pz.

Hose with stainless steel braiding, female female, DN10 Ø 14 mm
Box 100 pz.

Cod.	Dim.	L. mm	Kg/Pz.	Conf.	Pkg	Fin.	€
P130301	F3/8" x F3/8"	150	0,06	10		inox / steel	3,13
P130302	F3/8" x F3/8"	200	0,07	10		inox / steel	3,85
P130303	F3/8" x F3/8"	250	0,08	10		inox / steel	3,68
P130304	F3/8" x F3/8"	300	0,09	10		inox / steel	4,48
P130305	F3/8" x F3/8"	350	0,10	10		inox / steel	4,57
P130306	F3/8" x F3/8"	400	0,11	10		inox / steel	4,39
P130308	F3/8" x F3/8"	500	0,12	10		inox / steel	5,63
P130501	F1/2" x F3/8"	150	0,07	10		inox / steel	3,84
P130502	F1/2" x F3/8"	200	0,07	10		inox / steel	4,03
P130503	F1/2" x F3/8"	250	0,09	10		inox / steel	4,36
P130504	F1/2" x F3/8"	300	0,10	10		inox / steel	4,52
P130505	F1/2" x F3/8"	350	0,10	10		inox / steel	4,63
P130506	F1/2" x F3/8"	400	0,11	10		inox / steel	5,00
P130508	F1/2" x F3/8"	500	0,13	10		inox / steel	5,65
P130601	F1/2" x F1/2"	150	0,08	10		inox / steel	4,26
P130602	F1/2" x F1/2"	200	0,09	10		inox / steel	4,65
P130603	F1/2" x F1/2"	250	0,09	10		inox / steel	4,86
P130604	F1/2" x F1/2"	300	0,10	10		inox / steel	5,07
P130605	F1/2" x F1/2"	350	0,11	10		inox / steel	5,15
P130606	F1/2" x F1/2"	400	0,12	10		inox / steel	5,34
P130608	F1/2" x F1/2"	500	0,13	10		inox / steel	5,87
P130613	F1/2" x F1/2"	1000	0,21	10		inox / steel	11,00
P130618	F1/2" x F1/2"	1500	0,27	10		inox / steel	13,02



Flessibile in treccia di acciaio inox, DN10 Ø 14 mm, rosone foro esagonale in acciaio inox
Box 100 pz.

Hose with stainless steel braiding, DN10 Ø 14 mm with hexagonal hole cover plate
Box 100 pz.

Cod.	Dim.	L. mm	Kg/Pz.	Conf.	Pkg	Fin.	€
P190302R	M3/8" x F3/8"	200	0,10	10		inox / steel	5,33
P190303R	M3/8" x F3/8"	250	0,11	10		inox / steel	5,44
P190304R	M3/8" x F3/8"	300	0,12	10		inox / steel	5,63
P190305R	M3/8" x F3/8"	350	0,13	10		inox / steel	5,83
P190306R	M3/8" x F3/8"	400	0,13	10		inox / steel	6,02
P190308R	M3/8" x F3/8"	500	0,15	10		inox / steel	7,00
P190402R	M3/8" x F1/2"	200	0,11	10		inox / steel	5,63
P190403R	M3/8" x F1/2"	250	0,10	10		inox / steel	5,94
P190404R	M3/8" x F1/2"	300	0,12	10		inox / steel	6,25
P190405R	M3/8" x F1/2"	350	0,13	10		inox / steel	6,42
P190406R	M3/8" x F1/2"	400	0,14	10		inox / steel	6,66
P190408R	M3/8" x F1/2"	500	0,17	10		inox / steel	7,12
P190502R	M1/2" x F3/8"	200	0,11	10		inox / steel	5,46
P190503R	M1/2" x F3/8"	250	0,11	10		inox / steel	5,31
P190504R	M1/2" x F3/8"	300	0,12	10		inox / steel	5,53
P190505R	M1/2" x F3/8"	350	0,13	10		inox / steel	5,71
P190506R	M1/2" x F3/8"	400	0,14	10		inox / steel	5,90
P190508R	M1/2" x F3/8"	500	0,15	10		inox / steel	6,96
P190602R	M1/2" x F1/2"	200	0,11	10		inox / steel	5,68
P190603R	M1/2" x F1/2"	250	0,12	10		inox / steel	6,04
P190604R	M1/2" x F1/2"	300	0,13	10		inox / steel	6,19
P190605R	M1/2" x F1/2"	350	0,14	10		inox / steel	6,35
P190606R	M1/2" x F1/2"	400	0,14	10		inox / steel	6,25
P190608R	M1/2" x F1/2"	500	0,16	10		inox / steel	6,96
P190609R	M1/2" x F1/2"	600	0,17	10		inox / steel	7,96
P190613R	M1/2" x F1/2"	1000	0,24	10		inox / steel	12,07

Flessibili inox / Stainless steel flex hoses



Flessibile in treccia di acciaio inox, DN10 Ø 14 mm, esag.allungato 1/2", dado conico 3/8" x Ø 10, rosone foro esagonale in acciaio inox
Box 100 pz.

Hose with stainless steel braiding, DN10 Ø 14 mm with hexagonal hole cover plate
Box 100 pz.

Cod.	ø mm	L. mm	Kg/Pz.	Conf.	Pkg	Fin.	€
P180502R	10	200	0,14	10		inox / steel	7,98
P180503R	10	250	0,15	10		inox / steel	8,24
P180504R	10	300	0,16	10		inox / steel	8,45
P180506R	10	400	0,17	10		inox / steel	8,83
P180508R	10	500	0,19	10		inox / steel	10,06



Flessibili in treccia di acciaio inox, dado conico 3/8" x Ø 10, tubetto Ø 10 mm, DN8 Ø 12 mm
Box 100 pz.

Hose with stainless steel braiding, compression nut 3/8" x Ø 10, tube Ø 10mm, DN8 Ø 12 mm
Box 100 pz.

Cod.	ø mm	L. mm	Kg/Pz.	Conf.	Pkg	Fin.	€
P640202	10	200	0,07	2		inox / steel	5,08
P640203	10	250	0,08	2		inox / steel	5,07
P640204		300	0,09	2		inox / steel	5,32
P640205		350	0,10	2		inox / steel	5,53
P640206		400	0,10	2		inox / steel	6,11
P640207		500	0,10	2		inox / steel	5,99
P640210		1000	0,19	2		inox / steel	8,93



Flessibile in treccia di acciaio inox, attacco femmina, tubetto Ø 10 mm, DN8 Ø 12 mm
Box 100 pz.

Hose with stainless steel braiding, female, tube Ø 10 mm, DN8 Ø 12 mm
Box 100 pz.

Cod.	Dim.	L. mm	Kg/Pz.	Conf.	Pkg	Fin.	€
P650302	F3/8"	200	0,10	10		inox / steel	3,80
P650303	F3/8"	250	0,07	10		inox / steel	3,80
P650304	F3/8"	300	0,07	2		inox / steel	3,80
P650306	F3/8"	400	0,09	2		inox / steel	4,16
P650307	F3/8"	500	0,06	2		inox / steel	4,49
P650308	F3/8"	600	0,12	2		inox / steel	4,90
P650309	F3/8"	800	0,14	2		inox / steel	5,96
P650402	F1/2"	200	0,06	10		inox / steel	2,86
P650403	F1/2"	250	0,08	10		inox / steel	4,06
P650404	F1/2"	300	0,08	2		inox / steel	4,25
P650405	F1/2"	350	0,08	2		inox / steel	4,42
P650406	F1/2"	400	0,10	2		inox / steel	4,62
P650407	F1/2"	500	0,11	2		inox / steel	4,86
P650408	F1/2"	600	0,11	2		inox / steel	5,36

Flessibili inox / Stainless steel flex hoses



Flessibile in treccia di acciaio inox, con maschio e o-ring, attacco femmina, DN8 Ø 12 mm, confezionato in coppia Box 100 pz.

Hose with stainless steel braiding, male outlet with o-ring, female DN8 Ø 12 mm
Couple packed
Box 100 pz.

Cod.	Dim.	L. mm	Kg/Pz.	Conf.	Pkg	Fin.	€
P660204	F3/8" x M 10x1	300	0,07	2		inox / steel	3,96
P660206	F3/8" x M 10x1	400	0,09	2		inox / steel	4,25
P660208	F3/8" x M 10x1	500	0,10	2		inox / steel	4,57
P660104	F3/8" x M 10x1 Racc. M10 allungato F3/8" x M 10x1 Male M10 extended	300	0,08	2		inox / steel	4,71
P660106	F3/8" x M 10x1 Racc. M10 allungato F3/8" x M 10x1 Male M10 extended	400	0,09	2		inox / steel	5,08
P660108	F3/8" x M 10x1 Racc. M10 allungato F3/8" x M 10x1 Male M10 extended	500	0,11	2		inox / steel	5,34
P660404	F1/2" x M 10x1	300	0,08	2		inox / steel	4,64
P660406	F1/2" x M 10x1	400	0,09	2		inox / steel	5,35
P660408	F1/2" x M 10x1	500	0,10	2		inox / steel	5,00



Adattatori per flessibile per miscelatore, attacco femmina filetto M10 x 1, ottone cromato
Box 500 pz.

Adapter for hoses for mixers, inlet thread female M10 x 1, brass, chrome plated
Box 500 pz.

Cod.	Dim.	Kg/Pz.	Conf.	Pkg	Fin.	€
G036081	M 8x1	0,02	2		cr / chr	2,95
G036091	M 9x1	0,02	2		cr / chr	2,95
G036111	M 11x1	0,03	2		cr / chr	3,01
G036121	M 12x1	0,02	2		cr / chr	2,93

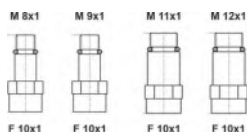

Flessibili antivibranti Inox / Vibration dumping inox hoses



Flessibile in treccia di acciaio
Box 20 pz.

Vibration-dumping flexible hose with stainless steel braiding plated
Box 20 pz.

Cod.	Dim.	ø mm	L. mm	Kg/Pz.	Conf.	Pkg	Fin.	€
P770201	M1/2" x F1/2"	20	300	0,16	1		inox / steel	9,71
P770202	M1/2" x F1/2"	20	400	0,19	1		inox / steel	10,63
P770203	M1/2" x F1/2"	20	500	0,22	1		inox / steel	11,55
P770204	M1/2" x F1/2"	20	600	0,26	1		inox / steel	12,47
P770206	M1/2" x F1/2"	20	1000	0,38	1		inox / steel	16,47
P770301	M3/4" x F3/4"	27	300	0,26	1		inox / steel	14,99
P770302	M3/4" x F3/4"	27	400	0,31	1		inox / steel	16,35
P770303	M3/4" x F3/4"	27	500	0,36	1		inox / steel	17,71
P770304	M3/4" x F3/4"	27	600	0,41	1		inox / steel	19,44
P770305	M3/4" x F3/4"	27	800	0,51	1		inox / steel	25,82
P770306	M3/4" x F3/4"	27	1000	0,61	1		inox / steel	30,07
P770401	M1" x F1"	34	300	0,44	1		inox / steel	23,78
P770402	M1" x F1"	34	400	0,52	1		inox / steel	26,02
P770403	M1" x F1"	34	500	0,61	1		inox / steel	28,26
P770404	M1" x F1"	34	600	0,68	1		inox / steel	30,50
P770405	M1" x F1"	34	800	0,85	1		inox / steel	36,60
P770406	M1" x F1"	34	1000	1,01	1		inox / steel	39,91
P770501	M1"1/4 x F1"1/4	44	300	0,71	1		inox / steel	47,00
P770502	M1"1/4 x F1"1/4	44	400	0,82	1		inox / steel	50,64
P770503	M1"1/4 x F1"1/4	44	500	0,94	1		inox / steel	54,16
P770504	M1"1/4 x F1"1/4	44	600	1,04	1		inox / steel	57,72
P770506	M1"1/4 x F1"1/4	44	1000	1,18	1		inox / steel	68,98
P770601	M1"1/2 x F1"1/2	54	300	1,20	1		inox / steel	65,61
P770602	M1"1/2 x F1"1/2	54	400	1,22	1		inox / steel	70,57
P770603	M1"1/2 x F1"1/2	54	500	1,42	1		inox / steel	75,44
P770604	M1"1/2 x F1"1/2	54	600	1,56	1		inox / steel	85,18
P770606	M1"1/2 x F1"1/2	54	1000	1,68	1		inox / steel	110,08
P770701	M2" x F2"	64	300	1,65	1		inox / steel	115,84
P770702	M2" x F2"	64	400	1,80	1		inox / steel	127,28
P770703	M2" x F2"	64	500	1,96	1		inox / steel	119,14
P770704	M2" x F2"	64	600	2,23	1		inox / steel	125,75
P770706	M2" x F2"	64	1000	2,60	1		inox / steel	186,32

made in Italy



La tecnologia che semplifica
dal 1961

A completamento delle linee VA Albertoni, è offerta una vasta gamma di sifoni, scarichi, aeratori, componenti per doccia e articoli colorati.

To complete VA ALBERTONI series, are offered a range of siphons, drains, aerators, components for showers and colored items.

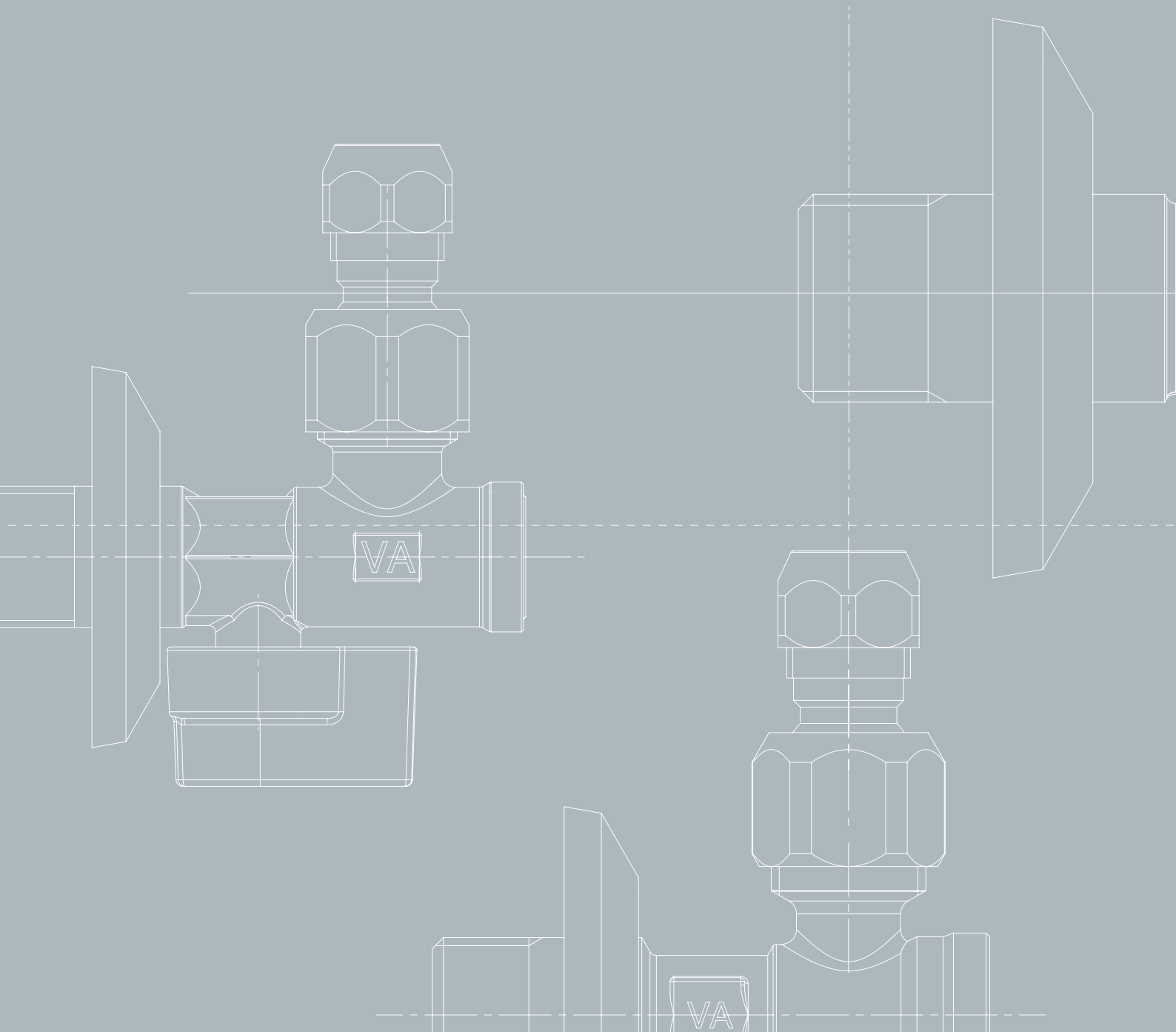

Sifoni

Siphons

Scarichi

Wastes

Aeratori

Aerators

Flessibili doccia

Shower hoses

Accessori per docce

Shower accessories

Colorati

Colors

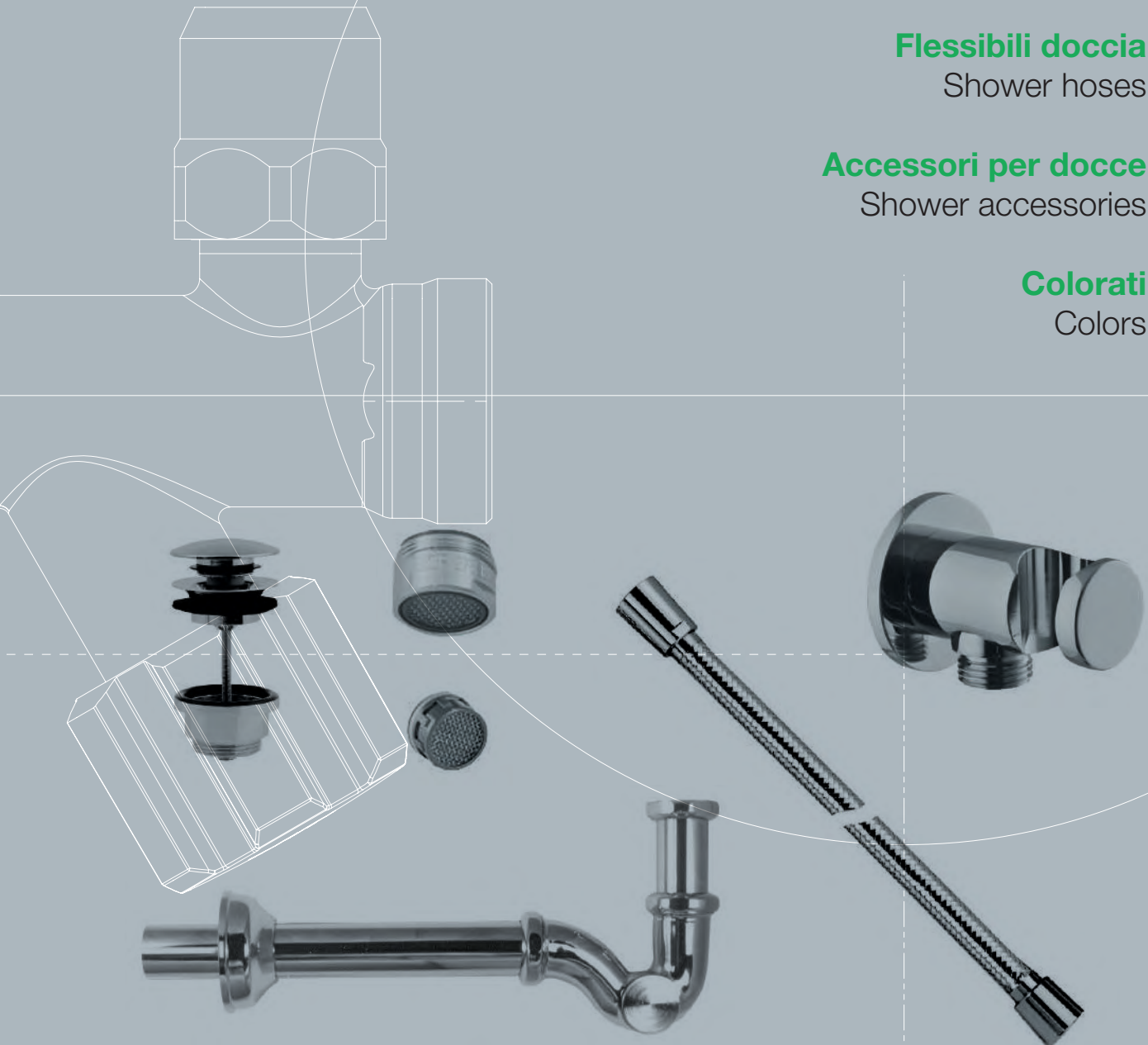

Sifoni / Siphons



Sifone a bottiglia, tubi 250 e 75 mm, rosone Box 30 pz.

Bottle-shaped siphon, pipes 250 and 75 mm, cover plate
Box 30 pz.

Cod.	Dim.	ø mm	Kg/Pz.	Conf.	Pkg	Fin.	€
K31726	1"	26	0,47	1		cr / chr	23,67
K31732	1" 1/4	32	0,56	1		cr / chr	27,25



Sifone a "S", tubi 250 e 75 mm, ispezione laterale, rosone Box 30 pz.

S-shaped siphon, lateral inspection plug, pipes 250 and 75 mm, cover plate
Box 30 pz.

Cod.	Dim.	ø mm	Kg/Pz.	Conf.	Pkg	Fin.	€
K32226	1"	26	0,43	1		cr / chr	23,67
K32232	1" 1/4	32	0,55	1		cr / chr	28,33



Sifone ad "U", tubi 250 e 75 mm, ispezione posteriore, rosone Box 30 pz.

U-shaped siphon, posterior inspection plug, pipes 250 and 75 mm, cover plate
Box 30 pz.

Cod.	Dim.	ø mm	Kg/Pz.	Conf.	Pkg	Fin.	€
K32426	1"	26	0,49	1		cr / chr	23,67
K32432	1" 1/4	32	0,56	1		cr / chr	28,33



Sifone bidet con gomito ribassato, con foro ispezione laterale
Box 30 pz.

Bidet siphon with reduced height, with lateral inspection hole
Box 30 pz.

Cod.	Dim.	ø mm	Kg/Pz.	Conf.	Pkg	Fin.	€
K32832	1"1/4	32	0,55	1		cr / chr	36,74



Intercalare per troppo pieno, ABS cromato
Box 50 pz.

External overflow ABS chrome plated
Box 50 pz.

Cod.	Kg/Pz.	Conf.	Pkg	Fin.	€
K34003	0,11	1		cr / chr	32,81



Sifone LINEA ITA 01
Box 10 pz.

Serie LINEA ITA 01
siphon
Box 10 pz.

Cod.	Dim.	ø mm	Kg/Pz.	Conf.	Pkg	Fin.	€
K31032	1"1/4	32	1,18	1		cr / chr	137,03



Sifone LINEA ITA 02
Box 10 pz.

Serie LINEA ITA 02
siphon
Box 10 pz.

Cod.	Dim.	ø mm	Kg/Pz.	Conf.	Pkg	Fin.	€
K31032T	1"1/4	32	0,87	1		cr / chr	80,37



Sifone QUADRO a
bottiglia
Box 10 pz.

Bottle-shaped siphon
QUADRO
Box 10 pz.

Cod.	Dim.	ø mm	Kg/Pz.	Conf.	Pkg	Fin.	€
K30235	1"1/4	32	1,05	1		cr / chr	159,91

Sifoni / Siphons



Sifone SALVA SPAZIO
Box 10 pz.

"SPACE SAVER" siphon
Box 10 pz.

Cod.	Dim.	ø mm	Kg/Pz.	Conf.	Pkg	Fin.	€
K30401	1"1/4	32	1,69	1		cr / chr	212,32



Curva 90° in ottone
per tubo Ø32 tenuta
o-ring
Box 50 pz.

Elbow 90° brass for
tube Ø 32
Box 50 pz.

Cod.	ø mm	L. mm	Kg/Pz.	Conf.	Pkg	Fin.	€
K30414	32	250	0,23	1		cr / chr	39,86

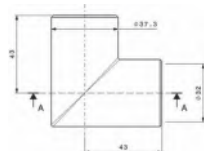

Curva 90° in ottone
per tubo Ø32 tenuta
o-ring, dado girevole
1"1/4
Box 50 pz.

Elbow 90° brass
for tube Ø 32 with
swivelling nut 1"1/4
Box 50 pz.

Cod.	ø mm	L. mm	Kg/Pz.	Conf.	Pkg	Fin.	€
K30413	32	250	0,38	1		cr / chr	55,36

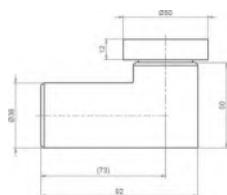



Piletta a scatto RAPID,
con troppo pieno,
UNIVERSALE, ottone
lucido, cromata, tappo
Ø 63
Box 20 pz.

Click-clack pop
up waste RAPID,
UNIVERSAL, polished
brass, chrome plated,
cap Ø 63
Box 20 pz.

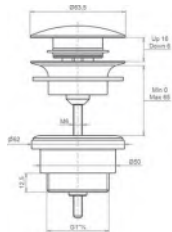

Cod.	Dim.	ø mm	Kg/Pz.	Conf.	Pkg	Fin.	€
K340015	1"1/4	32	0,36	1		cr / chr	39,79



Piletta a scatto EVO,
con troppo pieno,
UNIVERSALE, ottone
lucido, cromata, tappo
Ø32
Box 20 pz.

Click-clack pop
up waste EVO,
UNIVERSAL, polished
brass, chrome plated,
cap Ø 32
Box 20 pz.

Cod.	Dim.	Kg/Pz.	Conf.	Pkg	Fin.	€
K34020	1"1/4	0,30	1		cr / chr	38,39



Piletta a scarico libero,
con troppo pieno,
UNIVERSALE, ottone
lucido, cromata, tappo
Ø63
Box 20 pz.

Free flow waste,
UNIVERSAL, polished
brass, chrome plated,
cap Ø 63
Box 20 pz.

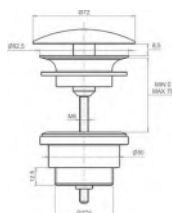

Cod.	Dim.	Kg/Pz.	Conf.	Pkg	Fin.	€
K34017	1"1/4	0,37	1		cr / chr	38,79

Scarichi / Wastes



Piletta lavabo
"SCATTO", lucidata,
cromata tappo Ø63,
H55 mm, con troppo-
pieno
Box 40 pz.

Pop-up waste
"SCATTO", chrome
plated, H55 mm, plug Ø
63 mm
Box 40 pz.

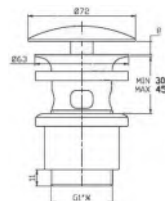

Cod.	Dim.	Kg/Pz.	Conf.	Pkg	Fin.	€
K34001	1"1/4	0,43	1		cr / chr	46,54
K34002	1"1/4 "SCARICO LIBERO" 1"1/4 "Free drain plug"	0,46	1		cr / chr	44,91
K3400111	1"1/4 H100 mm con troppo- pieno 1"1/4 H100 mm with overflow	0,49	1		cr / chr	60,01
K34006	1"1/4 Senza troppo-pieno 1"1/4 Without overflow	0,46	1		cr / chr	46,55
K3400112	1"1/4 H100 mm senza troppo- pieno 1"1/4 H100 mm without overflow	0,50	1		cr / chr	60,01



Distanziale per lavabo
H31 mm, ABS
Box 50 pz.

Spacer for basin, H31
mm, ABS chrome plated
Box 50 pz.

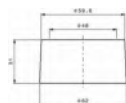

Cod.	Kg/Pz.	Conf.	Pkg	Fin.	€
K34004	0,03	1		cr / chr	6,69



Prolunga per piletta
a scatto maschio-
femmina, H90 mm
Box 50 pz.

Extension for pop-up
waste H90 mm
Box 50 pz.



Cod.	Dim.	Kg/Pz.	Conf.	Pkg	Fin.	€
K34050	1"1/4	0,21	1		cr / chr	48,71

Scarichi / Wastes



Solo tappo ottone
Ø 64
Box 50 pz.

Only brass plug Ø 64
Box 50 pz.

Cod.	Dim.	ø mm	Kg/Pz.	Conf.	Pkg	Fin.	€
K34005	1"1/4	64	0,11	1		cr / chr	12,18

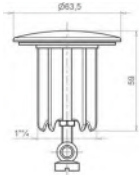

Solo tappo ottone
Box 200 pz.

Plug
Box 200 pz.

Cod.	Dim.	ø mm	Kg/Pz.	Conf.	Pkg	Fin.	€
K340055	1"1/4	39	0,08	1		cr / chr	7,96
K340056	1"	36	0,08	1		cr / chr	8,36

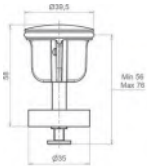

Snodo doppio per
piletta con salterello
Box 500 pz.

Double joint for pop-up
waste
Box 500 pz.

Cod.	Kg/Pz.	Conf.	Pkg	Fin.	€
K38000	0,01	1		cr / chr	1,90



Tappo copriforo, Ø50 mm, completo di guarnizioni
Box 50 pz.

Plug for hole with washers, Ø 50 mm
Box 50 pz.

Cod.	ø mm	Kg/Pz.	Conf.	Pkg	Fin.	€
K03285	10	0,09	1		cr / chr	6,04
ABB03285	10	0,09	1		bia / white	8,82

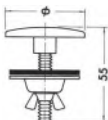

Piletta griglia ottone
Ø80
Box 50 pz.

Waste with brass grid
Ø 80
Box 50 pz.

Cod.	Dim.	Kg/Pz.	Conf.	Pkg	Fin.	€
K34300	1"1/4	0,19	1		cr / chr	15,94
K34301	1"1/2	0,21	1		cr / chr	17,36



Piletta lavabo ottone a crociera
Box 15 pz.

Waste with rubber plug
Box 15 pz.

Cod.	Dim.	Kg/Pz.	Conf.	Pkg	Fin.	€
K37001	1" 1/4	0,24	1		gg / br raw	18,97

Scarichi / Wastes



Piletta Gattinara Ø80
Box 50 pz.

Gattinara waste Ø 80
Box 50 pz.

Cod.	Dim.	Kg/Pz.	Conf.	Pkg	Fin.	€
K37010	1"1/4	0,18	1		gg / br raw	11,29



Tappo in gomma
rivestimento in acciaio
Box 500 pz.

Rubber plug stainless
steel covering
Box 500 pz.

Cod.	Dim.	ø mm	Kg/Pz.	Conf.	Pkg	€
K38051	1"1/4	40	0,03	1		6,40

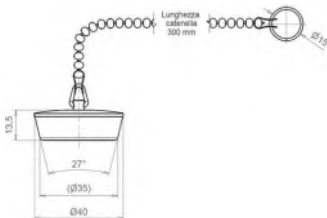

Tappo in gomma
Box 500 pz.

Rubber plug
Box 500 pz.

Cod.	Dim.	ø mm	Kg/Pz.	Conf.	Pkg	€
K38053	1"1/4	40	0,03	1		5,98

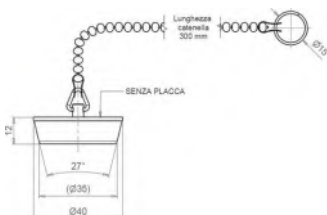

Aeratori / Aerators



Aeratore standard
Box 1000 pz.

Standard aerator
Box 1000 pz.

Cod.	Dim.	Kg/Pz.	Conf.	Pkg	Fin.	€
K10241	M 24 x 1	0,02	10		cr / chr	1,62
K10281	M 28 x 1	0,03	5		cr / chr	3,08
K10221	F 22 x 1	0,02	10		cr / chr	1,62



Aeratore con snodo
Box 300 pz.

Aerator with ball joint
Box 300 pz.

Cod.	Dim.	Kg/Pz.	Conf.	Pkg	Fin.	€
K13241	M 24 x 1	0,06	10		cr / chr	6,14
K13221	F 22 x 1	0,05	10		cr / chr	6,24



Aeratore linea
Box 1000 pz.

LINEA aerator
Box 1000 pz.

Cod.	Dim.	Kg/Pz.	Conf.	Pkg	Fin.	€
K10181	M 18 x 1	0,01	20		cr / chr	3,02
K10161	F 16 x 1	0,01	20		cr / chr	3,25

Aeratori / Aerators



Aeratore linea con
snodo
Box 240 pz.

LINEA aerator with ball
joint
Box 240 pz.

Cod.	Dim.	Kg/Pz.	Conf.	Pkg	Fin.	€
K13181	M 18 x 1	0,03	8		cr / chr	9,93
K13161	F 16 x 1	0,03	10		cr / chr	10,42



Aeratore anticalcare
siliconico
Box 1000 pz.

Aerator with lime
protection
Box 1000 pz.

Cod.	Dim.	Kg/Pz.	Conf.	Pkg	Fin.	€
K10241AC	M 24 x 1	0,02	10		cr / chr	4,45
K10281AC	M 28 x 1	0,03	5		cr / chr	10,14
K10221AC	F 22 x 1	0,02	10		cr / chr	4,21



Aeratore portata
limitata 6 l/min
Box 1000 pz.

Aerator max flow rate
6 l/min
Box 1000 pz.

Cod.	Dim.	Kg/Pz.	Conf.	Pkg	Fin.	€
K102416L	M 24 x 1	0,02	10		cr / chr	7,39
K102216L	F 22 x 1	0,02	10		cr / chr	7,27

Aeratori / Aerators



Aeratore antibatterico
Box 1000 pz.

Antibacterial aerator
Box 1000 pz.

Cod.	Dim.	Kg/Pz.	Conf.	Pkg	Fin.	€
K10241AB	M 24 x 1	0,02	10		cr / chr	2,14
K10221AB	F 22 x 1	0,02	10		cr / chr	2,11



Aeratore incasso con
chiave
Box 400 pz.

Hidden faucet aerator
with key
Box 400 pz.

Cod.	Dim.	Kg/Pz.	Conf.	Pkg	Fin.	€
K10300	16,5 x 1	0,01	1		cr / chr	5,61
K10301	18,5 x 1	0,01	1		cr / chr	5,61
K10302	21,5 x 1	0,01	1		cr / chr	5,61
K10303	24 x 1	0,01	1		cr / chr	5,61



Adattatore in ottone
Box 500 pz.

Brass connection
Box 500 pz.

Cod.	Dim.	Kg/Pz.	Conf.	Pkg	Fin.	€
G03602	M 24 x 1 x M3/4"	0,04	10		cr / chr	4,04
G03608	M 24 x 1 x M 22 x 1	0,01	10		cr / chr	3,91
G03600	M 24 x 1 x M1/2"	0,03	10		cr / chr	4,18
G03604	F 22 x 1 x M3/4"	0,04	10		cr / chr	3,69

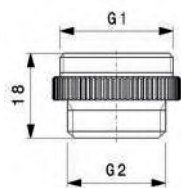

Flessibili doccia / Shower hoses



Flessibile doccia
LINEA ARGENTO,
cono ottone 1/2" +
cono girevole 1/2"
Box 25 pz.

Shower hose LINEA
ARGENTO, brass nut
1/2" swiveling
Box 25 pz.

Cod.	L. mm	Kg/Pz.	Conf.	Pkg	Fin.	€
K064620	1500	0,28	1		cr / chr	23,23
K064622	2000	0,36	1		cr / chr	27,97



Flessibile doccia
LINEA, cono ottone
1/2" + cono ottone
girevole 1/2"
Box 25 pz.

Shower hose LINEA,
brass nut 1/2" swiveling
Box 25 pz.

Cod.	L. mm	Kg/Pz.	Conf.	Pkg	Fin.	€
K064420	1500	0,27	1		cr / chr	17,96
K064422	2000	0,32	1		cr / chr	20,50



Flessibile doccia
LINEA HELIX, cono
ottone 1/2" + cono
ottone girevole 1/2"
Box 25 pz.

Shower hose LINEA
HELIX, brass nut 1/2"
swiveling
Box 25 pz.

Cod.	L. mm	Kg/Pz.	Conf.	Pkg	Fin.	€
K064520	1500	0,26	1		cr / chr	13,27
K064522	2000	0,32	1		cr / chr	14,49

Flessibili doccia / Shower hoses



Flessibile doccia
INOX, cono ottone
1/2" + cono ottone
girevole 1/2"
Box 25 pz.

Shower hose INOX,
brass nut 1/2" swiveling
Box 25 pz.

Cod.	L. mm	Kg/Pz.	Conf.	Pkg	Fin.	€
K064720	1500	0,31	1		cr / chr	19,60
K064722	2000	0,38	1		cr / chr	23,71



Flessibile doccia
OTTONE, cono ottone
1/2" + cono ottone
girevole 1/2"
Box 50 pz.

Shower hose BRASS,
brass nut 1/2" swiveling
Box 50 pz.

Cod.	L. mm	Kg/Pz.	Conf.	Pkg	Fin.	€
K06122	1500	0,22	1		cr / chr	9,59
K06124	2000	0,29	1		cr / chr	10,26

Accessori per docce / Shower accessories



Presacqua a 90°
LINEA, rosone ottone
Box 50 pz.

Elbow for shower hose
LINEA, cover plate
Box 50 pz.

Cod.	Dim.	Kg/Pz.	Conf.	Pkg	Fin.	€
L02803	M1/2" x M1/2"	0,16	1		cr / chr	12,78

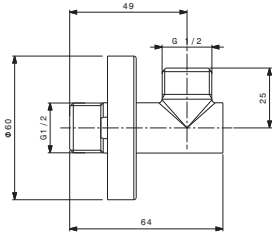

Presacqua
QUADRO, rosone
ottone, cromato
Box 50 pz.

Elbow for shower
QUADRO, cover plate,
chrome plated
Box 50 pz.

Cod.	Kg/Pz.	Conf.	Pkg	Fin.	€
L02803Q	0,25	1		cr / chr	28,13

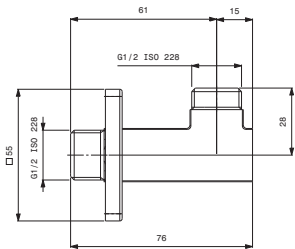

Presacqua con
supporto per doccetta
Box 100 pz.

Water outlet with shower
support
Box 100 pz.

Cod.	Dim.	Kg/Pz.	Conf.	Pkg	Fin.	€
L02832	1/2"	0,20	1		cr / chr	37,21

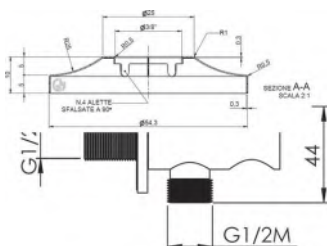

Accessori per docce / Shower accessories



Supporto snodato abs
tondo lux, 1 vite
Box 50 pz.

ABS adjustable bracket
lux, 1 fixing screw
Box 50 pz.

Cod.	Kg/Pz.	Conf.	Pkg	Fin.	€
K70405	0,05	1		cr / chr	11,93

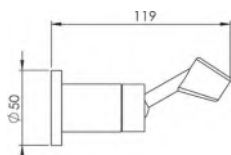

Supporto snodato abs
tondo eco, 1 vite
Box 50 pz.

ABS adjustable bracket
eco, 1 fixing screw
Box 50 pz.

Cod.	Kg/Pz.	Conf.	Pkg	Fin.	€
K70400	0,04	1		cr / chr	5,98

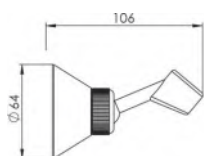

Set idroscopino
tondo ottone flessibile
antitorsione 120 cm,
acciaio cromato
Box 16 pz.

Set brass round shut-
off, flexible hose antiwist,
120 cm, stainless steel
Box 16 pz.

Cod.	Dim.	Kg/Pz.	Conf.	Pkg	Fin.	€
K70050	1/2"	0,80	1		cr / chr	69,75

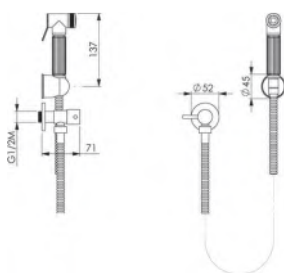

Accessori per docce / Shower accessories



Cannuccia flessibile
con aeratore, con
doppio attacco M
24x1 e F 22x1
Box 100 pz.

Brass double seam tube
with aerator
Box 100 pz.

Cod.	Dim.	Kg/Pz.	Conf.	Pkg	Fin.	€
K14241	F 22 x 1	0,10	1		cr / chr	28,34



Deviatore 1/2" x 1/2"
x 1/2"
Box 50 pz.

Derivator 1/2" x 1/2"
x 1/2"
Box 50 pz.

Cod.	Dim.	Kg/Pz.	Conf.	Pkg	Fin.	€
K15000	F1/2" x M1/2" x M1/2"	0,23	1		cr / chr	57,64

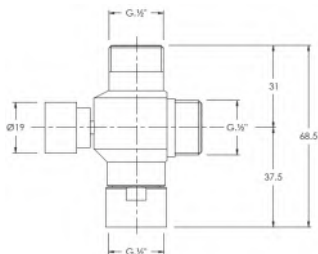

made in Italy



ALBERTONI

La tecnologia che semplifica
dal 1961

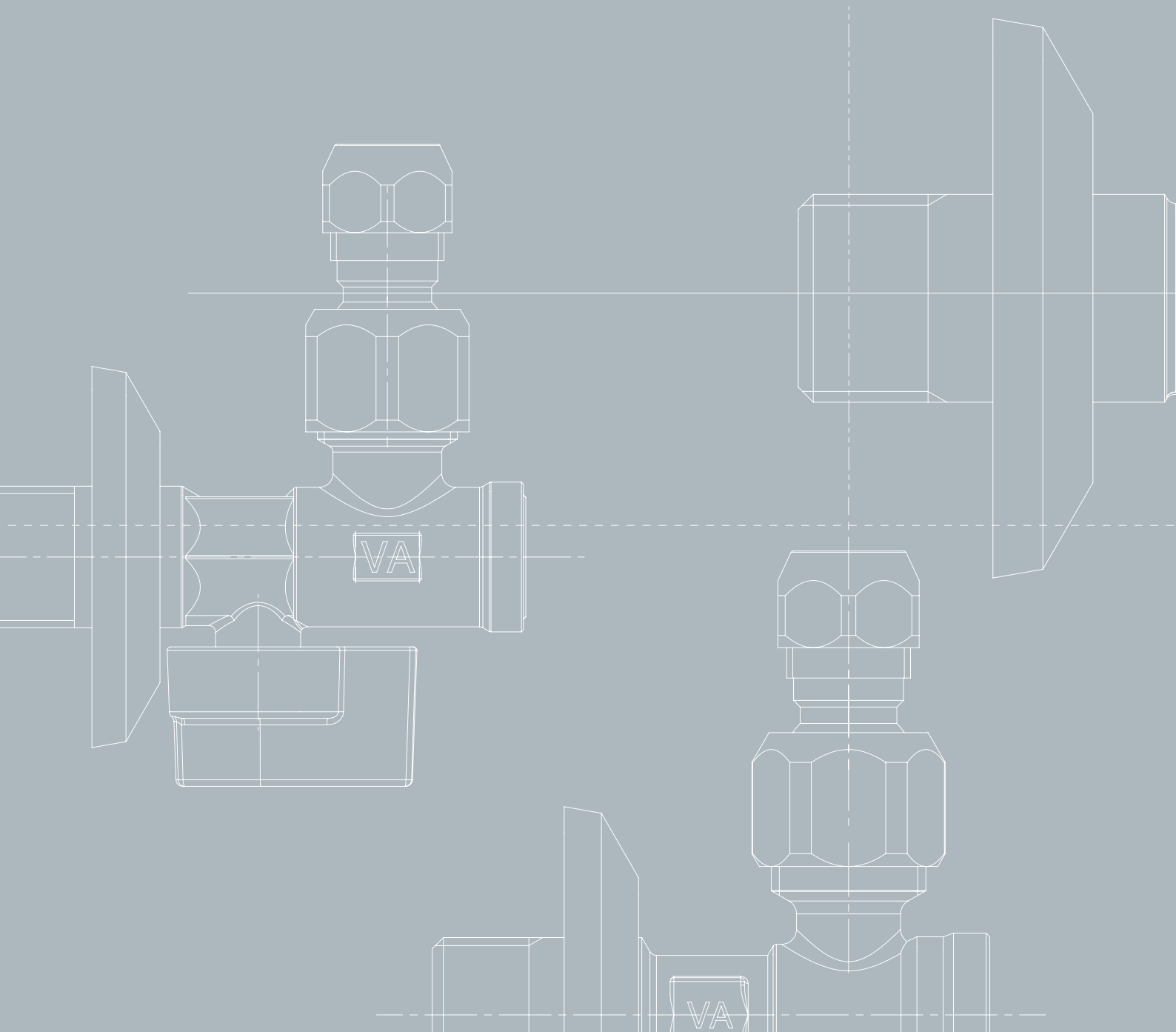

Colorati

Colors

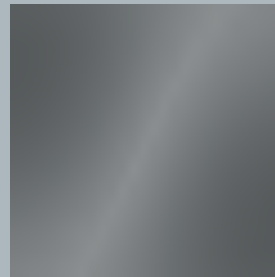
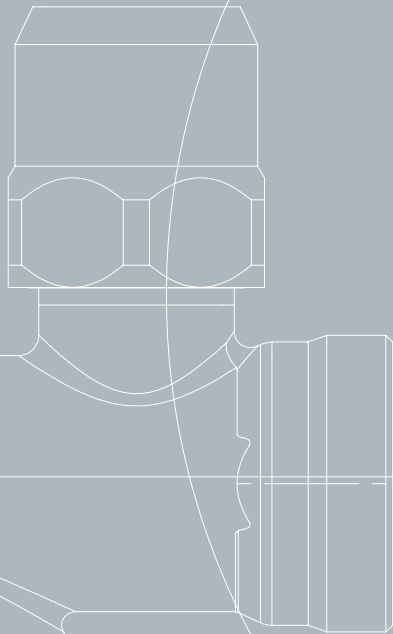

Nickel spazzolato
Brushed nickel



Flash oro
Flash gold

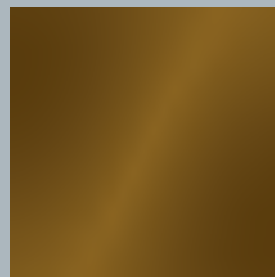

Bronzo
Bronze

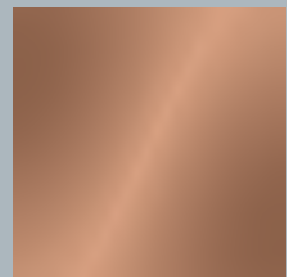

Ramato
Copper



Rubinetto sottolavabo con filtro, vitone, maniglia ottone, rosone ottone, snodo e dado conico
Box 50 pz.

Filtered angle valve, multiturn, brass handle, brass cover plate with ball joint and compression nut
Box 50 pz.

Cod.	Dim.	Kg/Pz.	Conf.	Pkg	Fin.	€
ANS147380	M1/2" x M3/8" x Ø10	0,28	2		Nickel spazzolato / Brushed nickel	47,73
ABZ147380	M1/2" x M3/8" x Ø10	0,30	2		Bronzo / Bronze	40,95
AFO147380	M1/2" x M3/8" x Ø10	0,29	2		Flash oro / Flash gold	67,76



Presca acqua a 90° LINEA, rosone ottone
Box 50 pz.

Elbow for shower hose LINEA, cover plate
Box 50 pz.

Cod.	Dim.	Kg/Pz.	Conf.	Pkg	Fin.	€
ABZ02803L	M1/2" x M1/2"	0,16	1		Bronzo / Bronze	23,19
AFO02803L	M1/2" x M1/2"	0,16	1		Flash oro / Flash gold	32,23
ARA02803L	M1/2" x M1/2"	0,16	1		Ramato / Copper	25,94



Squadra di raccordo in tubo rame, nipples giallo 1/2", rosone ottone, dado 1/2", confezionati a coppie
Box 100 pz.

Bent copper tube with 1/2" raw nipple, brass cover plate and 1/2" nut, packed 2 pieces in a bag
Box 100 pz.

Cod.	ø mm	L. mm	Kg/Pz.	Conf.	Pkg	Fin.	€
ANS312606	12	150x250	0,18	2		Nickel spazzolato / Brushed nickel	30,07
ABZ312606	12	150x250	0,16	2		Bronzo / Bronze	27,16
AFO312606	12	150x250	0,01	2		Flash oro / Flash gold	45,12
ARA312606	12	150x250	0,16	2		Ramato / Copper	30,38
AFO314610	14	150x250	0,19	2		Flash oro / Flash gold	45,12



Tubo pieghevole di rame, due flange stampate da 1/2" e 3/8"
Box 250 pz.

Copper tube with two flanges 1/2" and 3/8"
Box 250 pz.

Cod.	ø mm	L. mm	Kg/Pz.	Conf.	Pkg	Fin.	€
ABZ371406	10	400	0,06	1		Bronzo / Bronze	18,79
AFO371406	10	400	0,06	1		Flash oro / Flash gold	18,79
ARA371406	10	400	0,06	1		Ramato / Copper	15,12



Dado conico basso completo di guarnizioni
Box 1000 pz.

Brass compression nut with washers
Box 1000 pz.

Cod.	Dim.	Kg/Pz.	Conf.	Pkg	Fin.	€
ABZ12221	F3/8" x Ø10	0,01	1		Bronzo / Bronze	2,91
AFO12221	F3/8" x Ø10	0,01	1		Flash oro / Flash gold	5,63
ARA12221	F3/8" x Ø10	0,01	1		Ramato / Copper	3,38
ABZ12223	F1/2" x Ø10	0,02	1		Bronzo / Bronze	5,37
AFO12223	F1/2" x Ø10	0,02	1		Flash oro / Flash gold	10,43
ARA12223	F1/2" x Ø10	0,02	1		Ramato / Copper	6,75



Dado normale in ottone senza guarnizioni
Box 1500 pz.

Brass nut without washers
Box 1500 pz.

Cod.	Dim.	Kg/Pz.	Conf.	Pkg	Fin.	€
ABZ10201	F3/8" x Ø10	0,01	1		Bronzo / Bronze	2,98
ARA10201	F3/8" x Ø10	0,01	1		Ramato / Copper	3,50
ABZ10204	F1/2" x Ø10	0,02	1		Bronzo / Bronze	3,40
AFO10204	F1/2" x Ø10	0,02	1		Flash oro / Flash gold	6,12
ARA10204	F1/2" x Ø10	0,02	1		Ramato / Copper	4,17

Tubo diritto in ottone,
spessore tubo 0,5 mm
Box 100 pz.



Drain straight tube
Box 100 pz.

Cod.	ø mm	L. mm	Kg/Pz.	Conf.	Pkg	Fin.	€
ABZ04188	30	300	0,14	1		Bronzo / Bronze	18,26
AFO04188	30	300	0,12	1		Flash oro / Flash gold	21,79
ARA04188	30	300	0,12	1		Ramato / Copper	18,26
ANS04193	32	300	0,13	1		Nickel spazzolato / Brushed nickel	18,26
ABZ04193	32	300	0,13	1		Bronzo / Bronze	18,26
AFO04193	32	300	0,13	1		Flash oro / Flash gold	21,79
ARA04193	32	300	0,13	1		Ramato / Copper	18,26

Tubo diritto in ottone
con flangia, spessore
tubo 0,5 mm
Box 100 pz.



Drain straight tube with
flange
Box 100 pz.

Cod.	Dim.	ø mm	L. mm	Kg/Pz.	Conf.	Pkg	Fin.	€
ABZ04151	Fl. 1"	26	300	0,10	1		Bronzo / Bronze	17,87
AFO04151	Fl. 1"	26	300	0,11	1		Flash oro / Flash gold	21,33
ANS04155	Fl. 1"1/4	30	300	0,01	1		Nickel spazzolato / Brushed nickel	17,87
ABZ04155	Fl. 1"1/4	30	300	0,13	1		Bronzo / Bronze	17,87
ARA04155	Fl. 1"1/4	30	300	0,13	1		Ramato / Copper	17,87
ANS04159	Fl. 1"1/4	32	300	0,13	1		Nickel spazzolato / Brushed nickel	17,87
ABZ04159	Fl. 1"1/4	32	300	0,14	1		Bronzo / Bronze	17,87
AFO04159	Fl. 1"1/4	32	300	0,13	1		Flash oro / Flash gold	21,33
ARA04159	Fl. 1"1/4	32	300	0,13	1		Ramato / Copper	17,87

Tubo a 45° senza
flangia, in ottone,
spessore tubo 0,4
mm, con rosone foro
ovale
Box 1 pz.



45° drain tube
Box 1 pz.

Cod.	ø mm	L. mm	Kg/Pz.	Conf.	Pkg	Fin.	€
ABZ04103	30	140x160	0,13	1		Bronzo / Bronze	27,98
AFO04103	30	140x160	0,13	1		Flash oro / Flash gold	41,44
ARA04103	30	140x160	0,14	1		Ramato / Copper	27,98



Tubo a squadra
per scarico, ottone,
spessore tubo 0,5 mm
Box 100 pz.

Brass drain elbow tube
without flange
Box 100 pz.

Cod.	ø mm	L. mm	Kg/Pz.	Conf.	Pkg	Fin.	€
ANS04223	30	200x300	0,16	1		Nickel spazzolato / Brushed nickel	21,52
ABZ04223	30	200x300	0,16	1		Bronzo / Bronze	21,52
AFO04223	30	200x300	0,16	1		Flash oro / Flash gold	31,17
ARA04223	30	200x300	0,17	1		Ramato / Copper	21,52



Rosone scorrevole
ottone, con ghiera
Box 500 pz.

Sliding brass cover plate
with nylon
Box 500 pz.

Cod.	ø est.	L. mm	Kg/Pz.	Conf.	Pkg	Fin.	€
ABZ50128	57	3/8"	0,01	1		Bronzo / Bronze	6,83
ABZ50129	57	1/2"	0,01	1		Bronzo / Bronze	6,83
AFO50128	57	3/8"	0,01	1		Flash oro / Flash gold	11,21
AFO50129	57	1/2"	0,01	1		Flash oro / Flash gold	11,21
ARA50128	57	3/8"	0,01	1		Ramato / Copper	6,83
ANS50129	57	1/2"	0,01	1		Nickel spazzolato / Brushed nickel	6,83
ARA50129	57	1/2"	0,01	1		Ramato / Copper	6,83



Rosone ottone per
sottolavabo
Box 750 pz.

Brass cover plate
Box 750 pz.

Cod.	ø mm	ø est.	Kg/Pz.	Conf.	Pkg	Fin.	€
ABZ50119	10	55	0,01	1		Bronzo / Bronze	6,83
AFO50119	10	55	0,01	1		Flash oro / Flash gold	11,21
ARA50119	10	55	0,01	1		Ramato / Copper	6,83
AFO50120	12	55	0,01	1		Flash oro / Flash gold	11,21
AFO50121	14	55	0,01	1		Flash oro / Flash gold	11,21
ARA50121	14	55	0,01	1		Ramato / Copper	6,83



Rosone conico, per tubo adduzione WC
Box 500 pz.

Conical cover plate for drain tube
Box 500 pz.

Cod.	ø mm	ø est.	Kg/Pz.	Conf.	Pkg	Fin.	€
ABZ50149	26	75	0,01	1		Bronzo / Bronze	8,55
AFO50149	26	75	0,02	1		Flash oro / Flash gold	14,67
ARA50149	26	75	0,02	1		Ramato / Copper	8,55
ABZ50150	30	75	0,01	1		Bronzo / Bronze	8,55
ARA50150	30	75	0,02	1		Ramato / Copper	8,55
ANS50151	32	75	0,02	1		Nickel spazzolato / Brushed nickel	8,55
ABZ50151	32	75	0,02	1		Bronzo / Bronze	8,55
AFO50150	30	75	0,02	1		Flash oro / Flash gold	14,67
AFO50151	32	75	0,02	1		Flash oro / Flash gold	14,67
ARA50151	32	75	0,02	1		Ramato / Copper	8,55



Sifone a "S", tubi 250 e 75 mm, ispezione laterale, rosone
Box 30 pz.

S-shaped siphon, lateral inspection plug, pipes 250 and 75 mm, cover plate
Box 30 pz.

Cod.	Dim.	ø mm	Kg/Pz.	Conf.	Pkg	Fin.	€
ABZ32232	1" 1/4	32	0,67	1		Bronzo / Bronze	102,67
AFO32232	1" 1/4	32	0,73	1		Flash oro / Flash gold	139,28
ARA32232	1" 1/4	32	0,55	1		Ramato / Copper	98,73



Scarico 1" 1/4 lucidato, tappo ottone copripiletta, dado ottone
Box 50 pz.





Waste 1"1/4 polished, brass cover waste and brass nut
Box 50 pz.

Cod.	Dim.	Kg/Pz.	Conf.	Pkg	Fin.	€
AFO36001	1" 1/4	0,32	1		Flash oro / Flash gold	106,54



Piletta SCATTO
UNIVERSALE lucidata,
tappo Ø 63
Box 40 pz.

Pop-up waste
"SCATTO", plug Ø 63
mm, universal
Box 40 pz.

Cod.	Dim.	Kg/Pz.	Conf.	Pkg	Fin.	€
ANS340015	1" 1/4	0,36	1		Nickel spazzolato / Brushed nickel	82,58
ABZ340015	1" 1/4	0,36	1		Bronzo / Bronze	90,01
AFO340015	1" 1/4	0,36	1		Flash oro / Flash gold	125,84
ARA340015	1" 1/4	0,36	1		Ramato / Copper	90,01

made in Italy



ALBERTONI

La tecnologia che semplifica
dal 1961

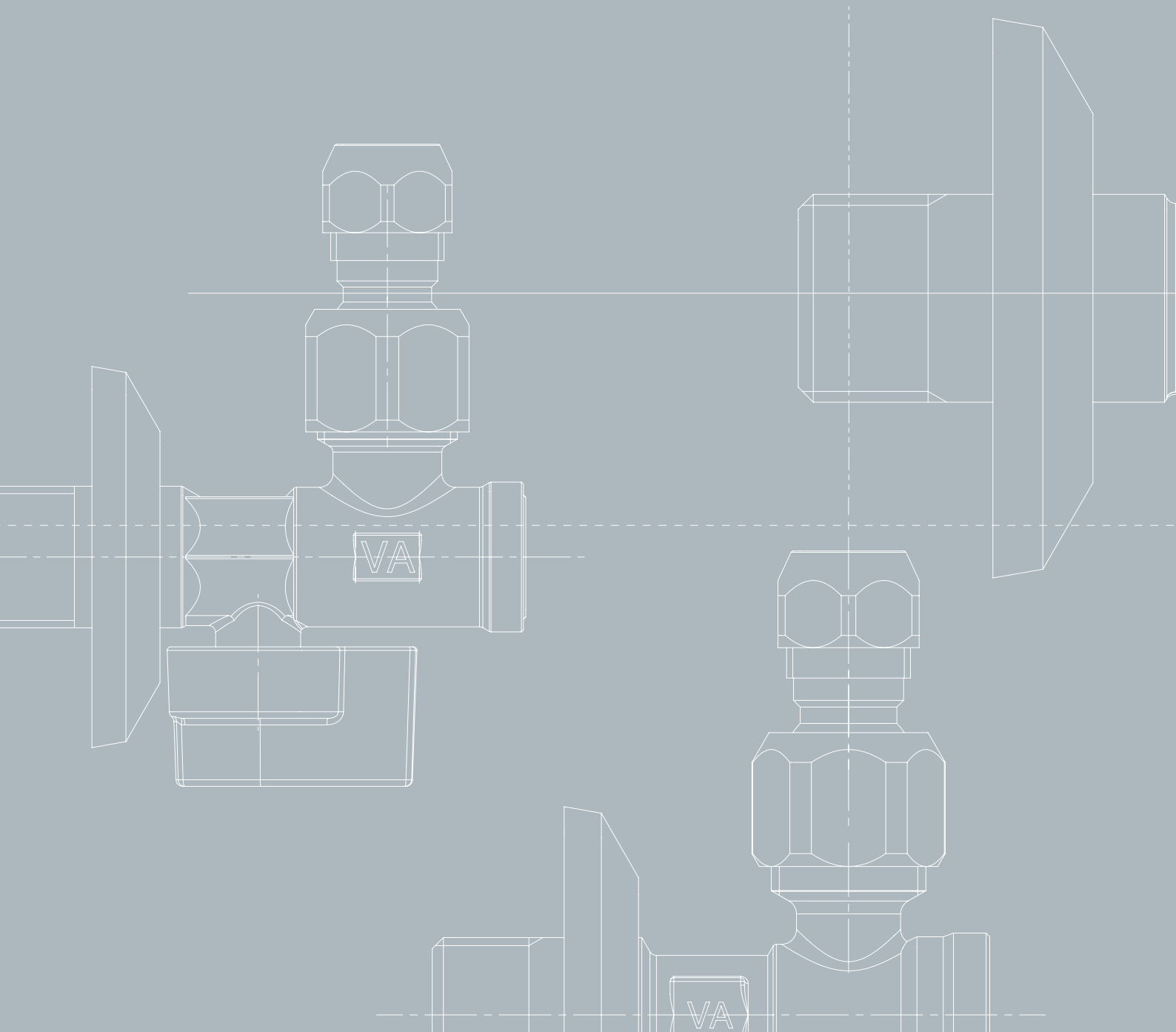

made in Italy



La tecnologia che semplifica
dal 1961

CATALOGO LISTINO \ PRICE LIST

2025

Indice per articolo

Article index

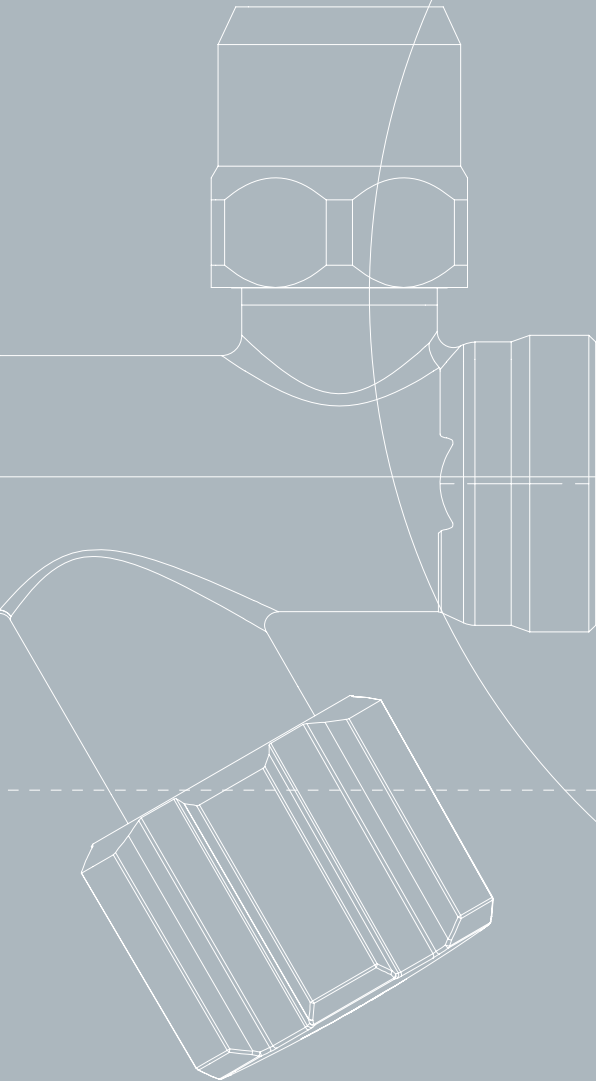

Indice per articolo / Article index

Cod.	Descrizione	Pag.	Cod.	Descrizione	Pag.
ABB03285	Tappo copriforo, Ø50 mm, completo di guarnizioni	150	AFO314610	Squadra di raccordo in tubo rame, nipples giallo 1/2", rosone ottone, dado 1/2", confezionati a coppie	162
ABZ02803L	Presa acqua a 90° LINEA, rosone ottone	162	AFO32232	Sifone a "S", tubi 250 e 75 mm, ispezione laterale, rosone	166
ABZ04103	Tubo a 45° senza flangia, in ottone, spessore tubo 0,4 mm, con rosone foro ovale	164	AFO340015	Piletta SCATTO UNIVERSALE lucidata, tappo Ø 63	167
ABZ04151	Tubo diritto in ottone con flangia, spessore tubo 0,5 mm	164	AFO36001	Scarico 1" 1/4 lucidato, tappo ottone copripiletta, dado ottone	166
ABZ04155	Tubo diritto in ottone con flangia, spessore tubo 0,5 mm	164	AFO371406	Tubo pieghevole di rame, due flange stampate da 1/2" e 3/8"	163
ABZ04159	Tubo diritto in ottone con flangia, spessore tubo 0,5 mm	164	AFO441650	Rubinetto sottolavabo LINEA, vitone, maniglia zama, con rosone ottone, con carter	15
ABZ04188	Tubo diritto in ottone, spessore tubo 0,5 mm	164	AFO446450	Rubinetto sottolavabo LINEA, vitone multigiuro, maniglia zama GOCCIA, rosone ottone	15
ABZ04193	Tubo diritto in ottone, spessore tubo 0,5 mm	164	AFO447650	Rubinetto sottolavabo LINEA, vitone, maniglia zama GOCCIA, rosone ottone, dado cilindrico	15
ABZ04223	Tubo a squadra per scarico, ottone, spessore tubo 0,5 mm	165	AFO448650L	Rubinetto sottolavabo LINEA, vitone multigiuro, maniglia zama GOCCIA, rosone ottone	15
ABZ10201	Dado normale in ottone senza guarnizioni	163	AFO50119	Rosone ottone per sottolavabo	165
ABZ10204	Dado normale in ottone senza guarnizioni	163	AFO50120	Rosone ottone per sottolavabo	165
ABZ12221	Dado conico basso completo di guarnizioni	163	AFO50121	Rosone ottone per sottolavabo	165
ABZ12223	Dado conico basso completo di guarnizioni	163	AFO50128	Rosone scorrevole ottone, con ghiera	165
ABZ147380	Rubinetto sottolavabo con filtro, vitone, maniglia ottone, rosone ottone, snodo e dado conico	162	AFO50129	Rosone scorrevole ottone, con ghiera	165
ABZ312606	Squadra di raccordo in tubo rame, nipples giallo 1/2", rosone ottone, dado 1/2", confezionati a coppie	162	AFO50149	Rosone conico, per tubo adduzione WC	166
ABZ32232	Sifone a "S", tubi 250 e 75 mm, ispezione laterale, rosone	166	AFO50150	Rosone conico, per tubo adduzione WC	166
ABZ340015	Piletta SCATTO UNIVERSALE lucidata, tappo Ø 63	167	AFO50151	Rosone conico, per tubo adduzione WC	166
ABZ371406	Tubo pieghevole di rame, due flange stampate da 1/2" e 3/8"	163	AGG02580COD	Raccordo a croce con dado girevole	108
ABZ441650	Rubinetto sottolavabo LINEA, vitone, maniglia zama, con rosone ottone, con carter	17	AGG103684	Rubinetto maschio, vitone ottone, maniglia ABS, giallo grezzo	82
ABZ446450	Rubinetto sottolavabo LINEA, vitone multigiuro, maniglia zama GOCCIA, rosone ottone	17	AGG106384SD	Rubinetto maschio, vitone ottone, maniglia ABS, anello di tenuta in PTFE, giallo grezzo	83
ABZ447650	Rubinetto sottolavabo LINEA, vitone, maniglia zama GOCCIA, rosone ottone, dado cilindrico	17	AMB441650	Rubinetto sottolavabo LINEA, vitone, maniglia zama, con rosone ottone, con carter	13
ABZ448650L	Rubinetto sottolavabo LINEA, vitone multigiuro, maniglia zama GOCCIA, rosone ottone	17	AMB446450	Rubinetto sottolavabo LINEA, vitone multigiuro, maniglia zama GOCCIA, rosone ottone	13
ABZ50119	Rosone ottone per sottolavabo	165	AMB447650	Rubinetto sottolavabo LINEA, vitone, maniglia zama GOCCIA, rosone ottone, dado cilindrico.	13
ABZ50128	Rosone scorrevole ottone, con ghiera	165	AMB448650L	Rubinetto sottolavabo LINEA, vitone multigiuro, maniglia zama GOCCIA, rosone ottone	13
ABZ50129	Rosone scorrevole ottone, con ghiera	165	ANS04155	Tubo diritto in ottone con flangia, spessore tubo 0,5 mm	164
ABZ50149	Rosone conico, per tubo adduzione WC	166	ANS04159	Tubo diritto in ottone con flangia, spessore tubo 0,5 mm	164
ABZ50150	Rosone conico, per tubo adduzione WC	166	ANS04193	Tubo diritto in ottone, spessore tubo 0,5 mm	164
ABZ50151	Rosone conico, per tubo adduzione WC	166	ANS04223	Tubo a squadra per scarico, ottone, spessore tubo 0,5 mm	165
AFO02803L	Presa acqua a 90° LINEA, rosone ottone	162	ANS147380	Rubinetto sottolavabo con filtro, vitone, maniglia ottone, rosone ottone, snodo e dado conico	162
AFO04103	Tubo a 45° senza flangia, in ottone, spessore tubo 0,4 mm, con rosone foro ovale	164	ANS312606	Squadra di raccordo in tubo rame, nipples giallo 1/2", rosone ottone, dado 1/2", confezionati a coppie	162
AFO04151	Tubo diritto in ottone con flangia, spessore tubo 0,5 mm	164	ANS340015	Piletta SCATTO UNIVERSALE lucidata, tappo Ø 63	167
AFO04159	Tubo diritto in ottone con flangia, spessore tubo 0,5 mm	164	ANS441650	Rubinetto sottolavabo LINEA, vitone, maniglia zama, con rosone ottone, con carter	14
AFO04188	Tubo diritto in ottone, spessore tubo 0,5 mm	164	ANS446450	Rubinetto sottolavabo LINEA, vitone multigiuro, maniglia zama GOCCIA, rosone ottone	14
AFO04193	Tubo diritto in ottone, spessore tubo 0,5 mm	164	ANS447650	Rubinetto sottolavabo LINEA, vitone, maniglia zama GOCCIA, rosone ottone, dado cilindrico	14
AFO04223	Tubo a squadra per scarico, ottone, spessore tubo 0,5 mm	165			
AFO10204	Dado normale in ottone senza guarnizioni	163			
AFO12221	Dado conico basso completo di guarnizioni	163			
AFO12223	Dado conico basso completo di guarnizioni	163			
AFO147380	Rubinetto sottolavabo con filtro, vitone, maniglia ottone, rosone ottone, snodo e dado conico	162			
AFO312606	Squadra di raccordo in tubo rame, nipples giallo 1/2", rosone ottone, dado 1/2", confezionati a coppie	162			

Indice per articolo / Article index

Cod.	Descrizione	Pag.	Cod.	Descrizione	Pag.
ANS448650L	Rubinetto sottolavabo LINEA, vitone multigiuro, maniglia zama GOCCIA, rosone ottone	14	B147380	Rubinetto sottolavabo con filtro, vitone, maniglia ottone, rosone inox, snodo e dado conico alto, cromato	23
ANS50129	Rosone scorrevole ottone, con ghiera	165	B147381	Rubinetto sottolavabo con filtro, vitone, maniglia ABS, rosone inox, snodo e dado conico alto, cromato	23
ANS50151	Rosone conico, per tubo adduzione WC	166	B147381SAC	Rubinetto sottolavabo con filtro, vitone, maniglia ABS, rosone inox, snodo e dado conico alto, cromato	23
ARA02803L	Presa acqua a 90° LINEA, rosone ottone	162	B147392	Rubinetto sottolavabo con filtro, vitone, maniglia ottone BIRILLI, rosone inox, snodo e dado conico, cromato	23
ARA04103	Tubo a 45° senza flangia, in ottone, spessore tubo 0,4 mm, con rosone foro ovale	164	B391281	Rubinetto sottolavabo con filtro, vitone resina anticalcare, maniglia ABS, rosone inox, snodo e dado conico, cromato	27
ARA04155	Tubo diritto in ottone con flangia, spessore tubo 0,5 mm	164	B392881	Rubinetto sottolavabo con filtro, vitone resina anticalcare, maniglia ABS, rosone inox, dado conico, cromato	27
ARA04159	Tubo diritto in ottone con flangia, spessore tubo 0,5 mm	164	B392981	Rubinetto sottolavabo con filtro, vitone resina anticalcare, maniglia ABS, rosone inox, cromato	27
ARA04188	Tubo diritto in ottone, spessore tubo 0,5 mm	164	B401201	Rubinetto sottolavabo con filtro, vitone, maniglia ABS bianca, rosone inox, snodo e dado conico, cromato	24
ARA04193	Tubo diritto in ottone, spessore tubo 0,5 mm	164	B401280	Rubinetto sottolavabo con filtro, vitone, maniglia ottone, rosone inox, snodo e dado conico, cromato	26
ARA04223	Tubo a squadra per scarico, ottone, spessore tubo 0,5 mm	165	B401281	Rubinetto sottolavabo con filtro, vitone, maniglia ABS, rosone inox, snodo e dado conico, cromato	25
ARA10201	Dado normale in ottone senza guarnizioni	163	B401481	Rubinetto sottolavabo con filtro, vitone, maniglia ABS, rosone inox, cromato	25
ARA10204	Dado normale in ottone senza guarnizioni	163	B402801	Rubinetto sottolavabo con filtro, vitone, maniglia ABS bianca, rosone inox, dado conico, cromato	24
ARA12221	Dado conico basso completo di guarnizioni	163	B402881	Rubinetto sottolavabo con filtro, vitone, maniglia ABS, rosone inox, dado conico, cromato	25
ARA12223	Dado conico basso completo di guarnizioni	163	B402901	Rubinetto sottolavabo con filtro, vitone, maniglia ABS bianca, rosone inox, cromato	24
ARA312606	Squadra di raccordo in tubo rame, nipples giallo 1/2", rosone ottone, dado 1/2", confezionati a coppie	162	B402980	Rubinetto sottolavabo con filtro, vitone, maniglia ottone, rosone inox, cromato	26
ARA32232	Sifone a "S", tubi 250 e 75 mm, ispezione laterale, rosone	166	B402981	Rubinetto sottolavabo con filtro, vitone, maniglia ABS, rosone inox, cromato	25
ARA340015	Piletta SCATTO UNIVERSALE lucidata, tappo Ø 63	167	B461281	Rubinetto sottolavabo a sfera con filtro, maniglia ABS, rosone inox, cromato	28
ARA371406	Tubo pieghevole di rame, due flange stampate da 1/2" e 3/8"	163	B462981	Rubinetto sottolavabo a sfera con filtro, maniglia ABS, rosone inox, cromato	28
ARA441650	Rubinetto sottolavabo LINEA, vitone, maniglia zama, con rosone ottone, con carter	16	B467281	Rubinetto sottolavabo a sfera con filtro, maniglia ABS, rosone inox, dado conico alto, cromato	28
ARA446450	Rubinetto sottolavabo LINEA, vitone multigiuro, maniglia zama GOCCIA, rosone ottone	16	C147486	Rubinetto sottolavabo H48, vitone ottone, maniglia triangolare zama, rosone inox, cromato	76
ARA447650	Rubinetto sottolavabo LINEA, vitone, maniglia zama GOCCIA, rosone ottone, dado cilindrico	16	C148486	Rubinetto sottolavabo H48, vitone ottone, maniglia triangolare zama, rosone inox, cromato	76
ARA448650L	Rubinetto sottolavabo LINEA, vitone multigiuro, maniglia zama GOCCIA, rosone ottone	16	C156484	Rubinetto sottolavabo H45, vitone ottone, maniglia ARBA zama, rosone inox, cromato	76
ARA50119	Rosone ottone per sottolavabo	165	C158684	Rubinetto sottolavabo H45, vitone ottone, maniglia ARBA zama, rosone inox, cromato	76
ARA50121	Rosone ottone per sottolavabo	165	C402281	Rubinetto sottolavabo STE H45, vitone HS, maniglia ABS, dado conico basso, rosone inox, cromato	71
ARA50128	Rosone scorrevole ottone, con ghiera	165	C406281	Rubinetto sottolavabo STE H45, vitone ottone, maniglia ABS, dado conico basso, rosone inox, cromato	69
ARA50129	Rosone scorrevole ottone, con ghiera	165	C406281SD	Rubinetto sottolavabo STE H45, vitone ottone, maniglia ABS, rosone inox, cromato	69
ARA50149	Rosone conico, per tubo adduzione WC	166			
ARA50150	Rosone conico, per tubo adduzione WC	166			
ARA50151	Rosone conico, per tubo adduzione WC	166			
B01201	Raccordo con filtro Maschio-Femmina, dado conico alto, cromato	29			
B140181	Rubinetto sottolavabo con filtro, vitone, maniglia ABS, rosone inox, snodo e dado conico alto, cromato	23			
B141481	Rubinetto sottolavabo con filtro, vitone, maniglia ABS, rosone inox, cromato	22			
B142481	Rubinetto sottolavabo con filtro, vitone, maniglia ABS, rosone inox, dado conico alto, anello di tenuta PTFE, cromato	22			
B142981	Rubinetto sottolavabo con filtro, vitone, maniglia ABS, rosone inox, cromato	22			
B144587	Rubinetto lavatrice con filtro, vitone ottone, maniglia ABS, rosone inox, cromato	51			
B147181	Rubinetto sottolavabo con filtro, vitone, maniglia ABS, rosone inox, dado conico alto, cromato	22			
B147281	Rubinetto sottolavabo con filtro, vitone, maniglia ABS, rosone inox, dado conico alto, cromato	22			
B147281SAC	Rubinetto sottolavabo con filtro, vitone, maniglia ABS, rosone inox, dado conico alto, cromato	22			

Indice per articolo / Article index

Cod.	Descrizione	Pag.	Cod.	Descrizione	Pag.
C407681	Rubinetto sottolavabo STE H45, vitone ottone, maniglia ABS, dado conico alto, rosone inox, cromato	69	D100281SD	Rubinetto ad angolo femmina, vitone ottone, maniglia ABS, cromato	81
C407881	Rubinetto sottolavabo STE H45, vitone ottone, maniglia ABS, dado conico alto, rosone inox, anello di tenuta PTFE, cromato	71	D100481	Rubinetto ad angolo femmina, vitone ottone, maniglia ABS, cromato	81
C408681	Rubinetto sottolavabo STE H45, vitone ottone, maniglia ABS, rosone inox, cromato	69	D100581	Rubinetto ad angolo femmina, vitone ottone, maniglia ABS, cromato	81
C426481	Rubinetto sottolavabo ASE H45, vitone ottone, maniglia ABS, rosone inox, cromato	68	D101081	Rubinetto diritto femmina, vitone ottone, maniglia ABS, cromato	80
C426481WR	Rubinetto sottolavabo ASE H45, vitone ottone, maniglia ABS bianca, rosone inox, cromato	68	D101181	Rubinetto diritto femmina, vitone ottone, maniglia ABS, cromato	80
C426485	Rubinetto sottolavabo ASE H45, vitone ottone, maniglia triangolare ABS, rosone inox, cromato	68	D101481	Rubinetto a V femmina, vitone ottone, maniglia ABS, cromato	80
C428681	Rubinetto sottolavabo ASE H45, vitone ottone, maniglia ABS, rosone inox, cromato	68	D101581	Rubinetto a V femmina, vitone ottone, maniglia ABS, cromato	80
C428681WR	Rubinetto sottolavabo ASE H45, vitone ottone, maniglia ABS bianca, rosone inox, cromato	68	D102281	Rubinetto ad angolo femmina entrata con ogiva, vitone ottone, maniglia ABS, dado girevole 3/8, cromato	81
C428685	Rubinetto sottolavabo ASE H45, vitone ottone, maniglia triangolare ABS, rosone inox, cromato	68	D102481	Rubinetto ad angolo femmina entrata con ogiva, vitone ottone, maniglia ABS, dado girevole 3/8, cromato	81
C446181	Rubinetto sottolavabo STE H45, vitone ottone, maniglia ABS, dado conico basso, rosone inox, cromato	69	D103481SD	Rubinetto maschio, vitone ottone, maniglia ABS	82
C446680	Rubinetto sottolavabo, vitone ottone, maniglia ottone, dado conico alto, rosone inox, cromato	70	D103681	Rubinetto maschio, vitone ottone, maniglia ABS	82
C446682	Rubinetto sottolavabo, vitone ottone, cappuccio chiuso, dado conico alto, rosone inox, cromato	70	D104081	Rubinetto maschio, vitone ottone, maniglia ABS, dado conico basso, cromato	84
C446692	Rubinetto sottolavabo, vitone ottone, maniglia ottone BIRILLO, dado conico alto, rosone inox, cromato	70	D104181	Rubinetto maschio, vitone ottone, maniglia ABS, dado conico basso, cromato	84
C447581	Rubinetto sottolavabo STE H45, vitone ottone, maniglia ABS, dado conico alto, rosone inox, cromato	69	D105686	Rubinetto sottolavabo H32, vitone ottone, asta fissa, maniglia triangolare zama con placchetta, cromato	77
C447781	Rubinetto sottolavabo STE H45, vitone ottone, maniglia ABS, dado conico alto, rosone inox, anello di tenuta PTFE, cromato	71	D106181	Rubinetto maschio, vitone ottone, maniglia ABS, dado conico alto, cromato	84
C498694	Rubinetto sottolavabo H48, vitone ottone, maniglia esagonale ABS, rosone inox, cromato	76	D106581	Rubinetto maschio, vitone ottone, maniglia ABS, anello di tenuta in PTFE, dado conico basso, cromato	83
C566281	Rubinetto sottolavabo STE H56, vitone ottone, maniglia ABS, dado conico basso, rosone inox, cromato	72	D110481	Rubinetto per cassetta maschio H29 mm, vitone ottone, maniglia ABS, codolo filettato 12/19 e dado, cromato	84
C566281SDSAC	Rubinetto sottolavabo STE H56, vitone ottone, maniglia ABS, senza dado, rosone inox, cromato	72	D110581	Rubinetto per cassetta maschio H29 mm, vitone ottone, maniglia ABS, codolo filettato 12/19 e dado, cromato	84
C567894	Rubinetto sottolavabo STE H56, vitone ottone, maniglia ABS, dado conico alto, rosone inox, anello di tenuta PTFE, cromato	72	D113381	Rubinetto per cassetta femmina, vitone ottone, maniglia ABS, codolo filettato 12/19 e dado, cromato	87
C568681	Rubinetto sottolavabo STE H56, vitone ottone, maniglia ABS, senza dado, rosone inox, cromato	72	D113581	Rubinetto per cassetta femmina, vitone ottone, maniglia ABS, codolo filettato 12/19 e dado, cromato	87
C657694	Rubinetto sottolavabo STE H65, vitone ottone, maniglia ABS, dado conico alto, rosone inox, cromato	73	D132081	Rubinetto per scaldabagno, vitone ottone, maniglia triangolare ABS, 2 dadi conici bassi, cromato	88
C657694SD	Rubinetto sottolavabo STE H65, vitone ottone, maniglia ABS, rosone inox, cromato	73	D145781	Rubinetto per cassetta femmina con prolunga rame e nipples giallo, vitone ottone, maniglia ABS, 2 dadi conici bassi, tubetto Ø10x120 mm, rosone, cromato	87
C658694	Rubinetto sottolavabo STE H65, vitone ottone, maniglia ABS, rosone inox, cromato	73	D145781ST	Rubinetto per cassetta femmina con prolunga rame e nipples giallo, vitone ottone, maniglia ABS, 2 dadi conici bassi, tubetto Ø10x120 mm, rosone, cromato	87
C846294	Rubinetto sottolavabo, maniglia ABS, rosone inox Ø76, interasse 84mm tutto filetto, cromato	71	D145881	Rubinetto per cassetta femmina con prolunga rame e nipples giallo, vitone ottone, maniglia ABS, 2 dadi conici bassi, tubetto Ø10x120 mm, rosone, cromato	87
D100181	Rubinetto ad angolo femmina, vitone ottone, maniglia ABS, dado conico basso, cromato	81	D1483801	Rubinetto da giardino ECO, maniglia ABS verde, giallo sabbaiato	64
D100181SD	Rubinetto ad angolo femmina, vitone ottone, maniglia ABS, cromato	81	D1484001	Rubinetto da giardino in ottone fuso con antiritorno, vitone con premistoppa, maniglia volantino colorata, portagomma, cromato sabbaiato	63
D100281	Rubinetto ad angolo femmina, vitone ottone, maniglia ABS, dado conico basso, cromato	81	D1484003	Rubinetto da giardino in ottone fuso con antiritorno, vitone con premistoppa, maniglia a chiave levabile, portagomma, cromato sabbaiato	63

Indice per articolo / Article index

Cod.	Descrizione	Pag.	Cod.	Descrizione	Pag.
D1484801	Rubinetto da giardino ECO, maniglia ABS verde, cromo sabbiato	64	D448686	Rubinetto dual pesante, vitoni ottone, maniglie ZAMA, rosone inox, cromato	79
D1484805	Rubinetto da giardino ECO, maniglia ABS verde, con portagomma, cromo sabbiato	64	D448894	Rubinetto dual pesante, vitoni ottone, maniglie ABS, rosone inox, cromato	78
D1488901	Rubinetto da giardino in ottone fuso, vitone con premistoppa, maniglia ottone, portagomma	62	D569694	Rubinetto per cassetta, vitone ottone, maniglia ABS, 2 dadi conici bassi, tubetto Ø10x120mm, rosone inox, cromato	86
D1488903	Rubinetto da giardino in ottone fuso, vitone con premistoppa, maniglia a chiave levabile, portagomma	62	D900085	Rubinetto combinato lavatrice, vitone ottone, maniglie ABS, dado conico alto, ghiera e portagomma, con aeratore anivuoto antiritorno, rosone inox, cromato	43
D1489901	Rubinetto da giardino in ottone fuso, vitone con premistoppa, maniglia ottone, portagomma	62	D9010851	Rubinetto di derivazione per lavatrice, vitone ottone con antiriflusso, maniglia ABS, dado conico alto, portagomma, cromato	54
D1489903	Rubinetto da giardino in ottone fuso, vitone con premistoppa, maniglia a chiave levabile, portagomma	62	D9011851	Rubinetto di derivazione per lavatrice, vitone ottone con antiriflusso, maniglia ABS, dado conico alto, cromato	54
D149181	Rubinetto per cassetta femmina con prolunga rame e nipples giallo, vitone ottone, maniglia ABS, codolo filettato 12/19, rosone, cromato	87	D901885	Rubinetto combinato lavatrice, vitone ottone antiritorno, maniglie ABS, dado conico alto, ghiera e portagomma, rosone inox, cromato	42
D149281	Rubinetto per cassetta femmina con prolunga rame e nipples giallo, vitone ottone, maniglia ABS, codolo filettato 12/19, rosone, cromato	87	D902085	Rubinetto combinato lavatrice, vitone ottone antiritorno, maniglie ABS, dado conico alto, ghiera e portagomma, rosone inox, cromato	42
D149481	Rubinetto per cassetta H45 mm, vitone ottone, maniglia ABS, codolo filettato 12/19 e dado, rosone inox, cromato	86	D9021851	Rubinetto combinato lavatrice, vitone ottone antireflusso, maniglie ABS, dado conico alto, rosone inox, cromato	42
D149581	Rubinetto per cassetta, vitone ottone, maniglia ABS, 2 dadi conici bassi, tubetto Ø10x120mm, rosone inox, cromato	86	D9021851SD	Rubinetto combinato lavatrice, vitone ottone, maniglie ABS, rosone inox, con vitone antiriflusso, cromato	42
D149681	Rubinetto per cassetta, vitone ottone, maniglia ABS, 2 dadi conici bassi, tubetto Ø10x120mm, rosone inox, cromato	86	D902285	Rubinetto combinato lavatrice, vitone ottone, maniglie ABS, dado conico basso, rosone inox, cromato	41
D150081	Kit completo per scaldabagno con prolunga rame e nipples giallo, vitone ottone, maniglia triangolare zama, codolo filettato 12/19, 2 dadi conici bassi, tubetto Ø10x120 mm, rosone, raccordo MF1/2, cromato	88	D902285GGSD	Rubinetto combinato lavatrice, vitone ottone, maniglie ABS, giallo sabbiato	45
D157187	Rubinetto arresto per scaldabagno, vitone ottone, maniglia ottone, cromato	88	D902285SD	Rubinetto combinato lavatrice, vitone ottone, maniglie ABS, rosone inox, cromato	41
D158187	Rubinetto arresto per scaldabagno, vitone ottone, maniglia ottone, cromato	88	D902380SD	Rubinetto combinato lavatrice, vitone ottone, maniglie ottone, rosone inox, cromato	43
D431981	Rubinetto diritto entrata con ogiva femmina 1/2 Ø 15 mm, vitone ottone, maniglia ABS, dado conico basso, cromato	85	D902385	Rubinetto combinato lavatrice, vitone ottone, maniglie ABS, dado conico alto, rosone inox, cromato	41
D433081	Rubinetto diritto femmina, vitone ottone, maniglia ABS, dado conico basso, cromato	85	D902594	Rubinetto combinato lavatrice leggero, vitone ottone, maniglie ABS, rosone inox, cromato	44
D436281	Rubinetto diritto maschio, vitone ottone, maniglia ABS, dado conico basso, cromato	85	D902594WR	Rubinetto combinato lavatrice leggero, vitone ottone, maniglie ABS bianche, rosone inox, cromato	44
D441094	Rubinetto a V, vitone ottone, maniglia ABS, rosone inox, cromato	80	D902694	Rubinetto combinato lavatrice leggero, vitone ottone, maniglie ABS, rosone inox, cromato	44
D441294	Rubinetto a V, vitone ottone, maniglia ABS, rosone inox, cromato	80	D9028851	Rubinetto combinato lavatrice, vitone ottone, maniglie ABS, dado conico alto, rosone inox, anello di tenuta PTFE, vitone antiriflusso, cromato	43
D443085	Rubinetto doppio lavatrice, vitoni ottone, maniglie ABS, portagomma, cromato	46	D903185	Rubinetto lavatrice con areatore antivuoato antiritorno, vitone ottone, maniglia triangolare ottone, con portagomma, cromato	48
D443185	Rubinetto doppio lavatrice, vitoni ottone, maniglie ABS, cromato	46	D9034851	Rubinetto combinato lavatrice con filtro incorporato al vitone, vitone brevettato n°22566 B/65, maniglie ABS, dado conico alto, rosone inox, cromato	40
D443285	Rubinetto doppio lavatrice, vitoni ottone, maniglie ABS, cromato	46	D903585	Rubinetto combinato lavatrice con filtro incorporato al vitone, vitone brevettato n°22566 B/65, maniglie ABS, snodo e dado conico alto, rosone inox, cromato	40
D443385	Rubinetto doppio lavatrice, vitoni ottone, maniglie ABS, portagomma, cromato	46	D904185	Rubinetto diritto lavatrice, maniglia ABS, vitone ottone antiritorno, cromato	50
D445694	Rubinetto dual leggero, vitoni ottone, maniglie ABS, rosone inox, cromato	78	D904689	Rubinetto diritto lavatrice, maniglia ABS, vitone ottone, cromato	50
D445694WR	Rubinetto dual leggero, vitoni ottone, maniglie ABS bianche, rosone inox, cromato	78	D904885	Rubinetto lavatrice, vitone ottone antiritorno, maniglia ABS, con portagomma, cromato	49
D446694	Rubinetto a croce, vitone ottone, maniglia ABS, rosone inox, cromato	77			
D446696	Rubinetto a croce, vitone ottone, maniglia zama, rosone inox, cromato	77			
D447694	Rubinetto dual pesante, vitoni ottone, maniglie ABS, rosone inox, cromato	78			
D448494	Rubinetto dual pesante, vitoni ottone, maniglie ABS, rosone inox, cromato	78			

Indice per articolo / Article index

Cod.	Descrizione	Pag.	Cod.	Descrizione	Pag.
D905085	Rubinetto lavatrice, vitone ottone antiritorno, maniglia ABS, con portagomma, cromato	49	E230263	Rubinetto sottolavabo pesante 100 mm, vitone ottone, cappuccio ottone chiuso, dado conico alto, rosone inox, cromato	74
D905385	Rubinetto lavatrice, vitone ottone, maniglia ABS, cromato	49	E330462	Rubinetto sottolavabo pesante 70 mm, vitone ottone, cappuccio ottone chiuso, dado conico alto, rosone inox, cromato	74
D905385R	Rubinetto lavatrice, vitone ottone, maniglia ABS, con rosone, cromato	49	E330562	Rubinetto sottolavabo pesante 100 mm, vitone ottone, cappuccio ottone chiuso, dado conico alto, rosone inox, cromato	74
D906089	Rubinetto per lavatrice verticale, vitone ottone, maniglia ABS, cromato	51	E330862	Rubinetto sottolavabo pesante 70 mm, vitone ottone, cappuccio ottone chiuso, dado conico alto, giallo sabbiato	74
D906189	Rubinetto per lavatrice verticale, vitone ottone, maniglia ABS, cromato	51	F1487000	Rubinetto da giardino in acciaio AISI304, vitone ceramico quarto di giro	62
D906489	Rubinetto per lavatrice a tre vie, vitone ottone, maniglia ABS, cromato	54	F1488000	Rubinetto da giardino in acciaio AISI304, vitone ceramico quarto di giro	62
D906773	Rubinetto lavatrice a sfera, maniglia ABS, rosone inox, cromato	52	F441650	Rubinetto sottolavabo LINEA Inox steel 316L, vitone inox multigiuro, maniglia inox, rosone inox, con carter	18
D9067733	Rubinetto lavatrice a sfera, maniglia ABS, rosone inox, cromato	52	F446450	Rubinetto sottolavabo LINEA Inox steel 316L, vitone inox multigiuro, maniglia inox, rosone inox	18
D907573	Valvola minisfera femmina-femmina cromata	90	F447650	Rubinetto sottolavabo LINEA Inox steel 316L, vitone inox multigiuro, maniglia inox, rosone inox, dado ottone	18
D907673	Valvola minisfera femmina-femmina cromata	90	F656494	Rubinetto sottolavabo INOX 316L H65mm, vitone CW724R, maniglia PA66, rosone inox Ø 77mm, cromato	73
D907773	Valvola minisfera femmina-femmina cromata	90	G003299	Ghiera e portagomma	57
D907873	Valvola minisfera femmina-femmina cromata	90	G02500	Raccordo diritto, dado conico basso	106
D907973	Valvola minisfera femmina-femmina cromata	90	G02501	Raccordo diritto, dado conico basso	106
D908073	Valvola minisfera maschio-femmina cromata	90	G02502	Raccordo diritto, dado conico basso	106
D908173	Valvola minisfera maschio-femmina cromata	90	G02503	Raccordo diritto, dado conico basso	106
D908273	Valvola minisfera maschio-femmina cromata	90	G02504	Raccordo diritto, dado conico basso	106
D908373	Valvola minisfera maschio-femmina cromata	90	G02505	Raccordo diritto, dado conico basso	106
D908473	Valvola minisfera maschio-femmina cromata	90	G02506	Raccordo diritto, dado conico basso	106
D908573	Valvola minisfera maschio-maschio cromata	90	G025065	Raccordo diritto, dado conico basso	106
D908673	Valvola minisfera maschio-maschio cromata	90	G02507	Raccordo maschio-femmina, dado conico	106
D908773	Valvola minisfera maschio-maschio cromata	90	G02508	Raccordo maschio-femmina, dado conico	106
D909000	Rubinetto lavatrice a sfera, maniglia ottone, rosone ottone, cromato	52	G02509	Raccordo maschio-femmina, dado conico	106
D909073	Rubinetto lavatrice a sfera, maniglia ABS, rosone inox, cromato	53	G02510	Raccordo maschio-femmina, dado conico	106
D909073R	Rubinetto lavatrice a sfera, maniglia ABS, rosone inox, con valvola antiritorno, cromato	53	G02511	Raccordo maschio-femmina, dado conico	106
D911500	Rubinetto lavatrice LINEA, vitone ottone, maniglia ottone, rosone ottone, cromato	48	G02512	Raccordo maschio-femmina, dado conico	106
D911585	Rubinetto lavatrice, vitone ottone, maniglia triangolare ottone, rosone ottone, lucidato e cromato	48	G02513	Raccordo maschio-femmina, dado conico	106
D912285SD	Rubinetto mono lavatrice con filtro, vitone ottone, maniglia ABS, rosone inox, cromato	40	G02514	Raccordo maschio-femmina, dado conico	106
D913485	Rubinetto per lavatrice a tre vie, vitone ottone, maniglia triangolare ABS, portagomma, cromato	55	G02515	Raccordo diritto doppio, dadi conici	106
D913685	Rubinetto per lavatrice a tre vie, vitone ottone, maniglia triangolare ABS, portagomma, cromato	55	G02516	Raccordo diritto doppio, dadi conici	106
D914689	Rubinetto lavatrice, vitone ottone, maniglia ABS, rosone inox, cromato	50	G02517	Raccordo diritto doppio, dadi conici	106
D916485	Rubinetto mono lavatrice, vitone ottone, maniglia ABS, rosone inox, con tappo ottone 3/4 e laccio, senza dado, sabbiato cromato	44	G02518	Raccordo maschio-femmina, dado conico	106
D920085	Rubinetto doppio, vitone ottone, maniglie triangolari ABS, areatore, con portagomma, cromato	47	G02519	Raccordo diritto doppio, dadi conici	106
D920185	Rubinetto doppio, vitone ottone, maniglie triangolari ABS, areatore, cromato	47	G02520	Raccordo diritto doppio, dadi conici	106
E134465	Rubinetto combinato lavatrice, vitone ottone, maniglia ottone e manettino colorato, tappo 3/4, dado conico alto, giallo sabbiato	45	G02521	Raccordo diritto doppio, dadi conici	106
E134466	Rubinetto combinato lavatrice, vitone ottone, maniglia ottone e manettino colorato, tappo 3/4, dado conico alto, giallo sabbiato	45	G02522	Raccordo diritto doppio, dadi conici	106
E134466SD	Rubinetto combinato lavatrice, vitone ottone, maniglia ottone e manettino nylon colorato, tappo 3/4, giallo sabbiato	45	G02523	Raccordo a 90°, dadi conici bassi	107
E230168	Rubinetto sottolavabo pesante 70 mm, vitone ottone, cappuccio ottone chiuso, dado conico alto, rosone inox, cromato	74	G02524	Raccordo a 90°, dadi conici bassi	107
			G02525	Raccordo a 90°, dadi conici bassi	107
			G02528	Raccordo a 90°, dadi conici bassi	107
			G02529	Raccordo a 90°, dadi conici bassi	107
			G02530	Raccordo a 90°, dadi conici bassi	107
			G02531	Raccordo a 90°, dado conico basso, attacco maschio	107
			G02531COD	Raccordo a 90°, dado conico basse e codolo con dado girevole	107
			G02532	Raccordo a 90°, dado conico basso, attacco maschio	107
			G02533	Raccordo a 90°, dado conico basso, attacco maschio	107
			G02534	Raccordo a 90°, dado conico basso, attacco maschio	107

Indice per articolo / Article index

Cod.	Descrizione	Pag.
G02535	Raccordo 90°, dado conico basso, attacco femmina	109
G02536	Raccordo 90°, dado conico basso, attacco femmina	109
G02537	Raccordo 90°, dado conico basso, attacco femmina	109
G02538	Raccordo 90°, dado conico basso, attacco femmina	109
G02539	Raccordo a T, dadi conici bassi	108
G02540	Raccordo a T, dadi conici bassi	108
G02540COD	Raccordo a T, 2 dadi conici bassi e codolo con dado girevole	108
G02541	Raccordo a T, dadi conici bassi	108
G02542	Raccordo a 90°, dado conico basso, attacco maschio	107
G02544	Raccordo a T, dadi conici bassi	108
G02545	Raccordo 90°, placca di fissaggio, dado conico	109
G02546	Raccordo 90°, placca di fissaggio, dado conico	109
G02549	Raccordo 90°, alette di fissaggio, dado conico basso	109
G02550	Raccordo 90°, alette di fissaggio, dado conico basso	109
G02551	Raccordo diritto, dado conico basso	106
G02552	Raccordo diritto, dado conico basso	106
G02553	Raccordo diritto, dado conico basso	106
G02554	Raccordo diritto, dado conico basso	106
G02560	Raccordo diritto H40, dado conico basso, rosone esagonale	35
G02561	Raccordo diritto H40, dado conico basso, rosone esagonale	35
G02562	Raccordo diritto H40, dado conico basso, rosone esagonale	35
G0256205	Raccordo diritto H40	35
G02562SD	Raccordo diritto H40, senza dado, rosone esagonale	35
G02563	Raccordo diritto H40, dado conico basso, rosone esagonale	35
G02564	Raccordo diritto H40, dado conico basso, rosone esagonale	35
G025650	Raccordo diritto H50, dado conico basso, rosone esagonale	36
G025650SD	Raccordo diritto H50, senza dado, rosone esagonale	36
G02580COD	Raccordo a croce con dado girevole	108
G02802	Curvetta 90° in ottone stampato, rosone inox, dado conico basso, cromata	32
G02803	Curvetta 90° in ottone stampato, rosone inox, cromata	32
G0280334	Curvetta 90° in ottone stampato, rosone inox, cromata	32
G02806	Curvetta 45° in ottone stampato, rosone inox, dado conico basso, cromata	34
G02807	Curvetta 45° in ottone stampato, rosone inox, dado conico alto, cromata	34
G02818	Prolunga H30 mm, dado conico basso, cromata	34
G02818SD	Prolunga H30 mm, dado conico basso, cromata	34
G02823	Curvetta 90° in ottone stampato, rosone inox, con snodo e dado conico basso, cromata	32
G02837	Curvetta 90° in ottone stampato, nipples, rosone inox, dado basso, cromata	33
G02838	Curvetta 90° in ottone stampato, nipples, rosone inox, dado basso, cromata	33
G02840	Curvetta 90° in ottone stampato, nipples, rosone inox, dado conico alto, cromata	33
G02866	Curva 90° MF dado girevole, cromata	89
G02867	Curva 90° MF dado girevole, cromata	89

Cod.	Descrizione	Pag.
G02868	Raccordo diritto MF con dado girevole, cromato	89
G02869	Raccordo diritto MF con dado girevole, cromato	89
G03003	Raccordo a Y maschio-femmina, ottone	95
G03004	Raccordo a Y maschio-femmina, ottone	95
G03034	Raccordo a crociera femmina, ottone	94
G03036	Raccordo a crociera femmina, ottone	94
G03038	Raccordo a crociera femmina, ottone	94
G03099	Manicotto femmina, ottone	94
G03100	Manicotto femmina, ottone	94
G03101	Manicotto femmina, ottone	94
G03102	Manicotto femmina, ottone	94
G03103	Manicotto femmina, ottone	94
G03104	Manicotto femmina, ottone	94
G03105	Manicotto femmina, ottone	94
G03106	Manicotto femmina, ottone	94
G03107	Manicotto femmina, ottone	94
G03108	Manicotto femmina, ottone	94
G03109	Manicotto femmina, ottone	94
G03110	Manicotto femmina, ottone	94
G03111	Manicotto femmina, ottone	94
G03112	Manicotto femmina, ottone	94
G03113	Manicotto femmina, ottone	94
G03114	Manicotto femmina, ottone	94
G03119	Curva 90° femmina, ottone	95
G03120	Curva 90° femmina, ottone	95
G03121	Curva 90° femmina, ottone	95
G03122	Curva 90° femmina, ottone	95
G03123	Curva 90° femmina, ottone	95
G03124	Curva 90° femmina, ottone	95
G03125	Curva 90° femmina, ottone	95
G03126	Curva 90° femmina, ottone	95
G03127	Curva 90° femmina, ottone	95
G03128	Curva 90° femmina, ottone	95
G03129	Curva 90° femmina, ottone	95
G03130	Curva 90° femmina, ottone	95
G03131	Curva 90° femmina, ottone	95
G03132	Curva 90° femmina, ottone	95
G03133	Curva 90° femmina, ottone	95
G03134	Curva 90° femmina, ottone	95
G03138	Raccordo a riduzione, maschio-femmina, ottone	97
G03139	Raccordo maschio-femmina, ottone	97
G03140	Raccordo maschio-femmina, ottone	97
G03141	Raccordo maschio-femmina, ottone	97
G031465	Raccordo a riduzione, maschio-femmina, ottone	97
G03148	Raccordo a riduzione, maschio-femmina, ottone	97
G03150	Raccordo a riduzione, maschio-femmina, ottone	97
G03151	Raccordo a T femmina, ottone	96
G03152	Raccordo a T femmina, ottone	96
G03153	Raccordo a T femmina, ottone	96
G03154	Raccordo a T femmina, ottone	96
G03155	Raccordo a T femmina, ottone	96
G03156	Raccordo a T femmina, ottone	96
G03157	Raccordo a T femmina, ottone	96
G03158	Raccordo a T femmina, ottone	96
G03159	Raccordo a T femmina, ottone	96
G03160	Raccordo a T femmina, ottone	96
G03161	Raccordo a T femmina, ottone	96
G03162	Raccordo a T femmina, ottone	96
G03163	Raccordo a T femmina, ottone	96
G03164	Raccordo a T femmina, ottone	96

Indice per articolo / Article index

Cod.	Descrizione	Pag.	Cod.	Descrizione	Pag.
G03170	Raccorto a T femmina, ottone	96	G032466	Raccordo maschio-femmina, speciale per pilette, ottone	96
G03171	Raccorto a T femmina, ottone	96	G03247	Raccordo a riduzione, maschio-femmina, ottone	97
G03172	Raccorto a T femmina, ottone	96	G03248	Raccordo a riduzione, maschio-femmina, ottone	97
G03173	Raccorto a T femmina, ottone	96	G03249	Raccordo a riduzione, maschio-femmina, ottone	97
G03174	Raccorto a T femmina, ottone	96	G03250	Raccordo a riduzione, maschio-femmina, ottone	97
G03179	Curva 90° maschio-femmina, ottone	95	G032501	Raccordo a riduzione, maschio-femmina, ottone	97
G03180	Curva 90° maschio-femmina, ottone	95	G03251	Raccordo a riduzione, maschio-femmina, ottone	97
G03181	Curva 90° maschio-femmina, ottone	95	G03252	Raccordo a riduzione, maschio-femmina, ottone	97
G03182	Curva 90° maschio-femmina, ottone	95	G03253	Raccordo a riduzione, maschio-femmina, ottone	97
G03183	Curva 90° maschio-femmina, ottone	95	G03254	Raccordo a riduzione, maschio-femmina, ottone	97
G03184	Curva 90° maschio-femmina, ottone	95	G03255	Raccordo a riduzione, maschio-femmina, ottone	97
G03185	Curva 90° maschio-femmina, ottone	95	G03256	Raccordo a riduzione, maschio-femmina, ottone	97
G03186	Curva 90° maschio-femmina, ottone	95	G032561	Raccordo a riduzione, maschio-femmina, ottone	97
G03187	Curva 90° maschio-femmina, ottone	95	G03257	Raccordo a riduzione, maschio-femmina, ottone	97
G03188	Curva 90° maschio-femmina, ottone	95	G03258	Raccordo a riduzione, maschio-femmina, ottone	97
G03189	Curva 90° maschio-femmina, ottone	95	G03259	Raccordo a riduzione, maschio-femmina, ottone	97
G03190	Curva 90° maschio-femmina, ottone	95	G03263	Tappo maschio con chiave quadra, ottone	99
G03191	Curva 90° maschio-femmina, ottone	95	G03264	Tappo maschio con chiave quadra, ottone	99
G03192	Curva 90° maschio-femmina, ottone	95	G03265	Tappo maschio con chiave quadra, ottone	99
G03193	Curva 90° maschio-femmina, ottone	95	G03266	Tappo maschio con chiave quadra, ottone	99
G03194	Curva 90° maschio-femmina, ottone	95	G03281	Tappo con vite e rosone, ottone	100
G03199	Vite doppia, ottone	98	G03282	Tappo con vite e rosone, ottone	100
G03200	Vite doppia, ottone	98	G03283	Tappo con vite e rosone, ottone	100
G03201	Vite doppia, ottone	98	G03291	Tappo con vite, ottone	100
G03202	Vite doppia, ottone	98	G03292	Tappo con vite, ottone	100
G03203	Vite doppia, ottone	98	G03293	Tappo con vite, ottone	100
G03204	Vite doppia, ottone	98	G03295	Tappo esagonale femmina, ottone	99
G03205	Vite doppia, ottone	98	G03296	Tappo esagonale femmina, ottone	99
G03206	Vite doppia, ottone	98	G03297	Tappo esagonale femmina, ottone	99
G03207	Vite doppia, ottone	98	G03298	Tappo esagonale femmina, ottone	99
G03208	Vite doppia, ottone	98	G03305	Tappo esagonale femmina, ottone	99
G03209	Vite doppia, ottone	98	G03306	Tappo esagonale femmina, ottone	99
G03210	Vite doppia, ottone	98	G03307	Tappo esagonale femmina, ottone	99
G03211	Vite doppia, ottone	98	G03308	Tappo esagonale femmina, ottone	99
G03212	Vite doppia, ottone	98	G03314	Tappo maschio esagonale, ottone	99
G03213	Vite doppia, ottone	98	G03315	Tappo maschio esagonale, ottone	99
G03214	Vite doppia, ottone	98	G03316	Tappo maschio esagonale, ottone	99
G032208	Vite doppia ridotta, ottone	98	G03317	Tappo maschio esagonale, ottone	99
G032209	Vite doppia ridotta, ottone	98	G03318	Tappo maschio esagonale, ottone	99
G03221	Vite doppia ridotta, ottone	98	G03319	Tappo maschio esagonale, ottone	99
G03222	Vite doppia ridotta, ottone	98	G03320	Tappo maschio esagonale, ottone	99
G03223	Vite doppia ridotta, ottone	98	G03321	Tappo maschio esagonale, ottone	99
G03224	Vite doppia ridotta, ottone	98	G03324	Tappo maschio esagonale, ottone	99
G03225	Vite doppia ridotta, ottone	98	G03325	Tappo maschio esagonale, ottone	99
G03226	Vite doppia ridotta, ottone	98	G03326	Tappo maschio esagonale, ottone	99
G03227	Vite doppia ridotta, ottone	98	G03327	Tappo maschio esagonale, ottone	99
G03228	Vite doppia ridotta, ottone	98	G03328	Tappo maschio esagonale, ottone	99
G03229	Vite doppia ridotta, ottone	98	G03329	Tappo maschio esagonale, ottone	99
G03230	Vite doppia ridotta, ottone	98	G03330	Tappo maschio esagonale, ottone	99
G03231	Vite doppia ridotta, ottone	98	G03331	Tappo maschio esagonale, ottone	99
G03232	Vite doppia ridotta, ottone	98	G03401	Ghiera maschio-femmina, ottone	98
G03240	Raccordo a riduzione, maschio-femmina, ottone	97	G03402	Ghiera maschio-femmina, ottone	98
G032401	Raccordo a riduzione, maschio-femmina, ottone	97			
G03241	Raccordo maschio-femmina, ottone	97			
G03242	Raccordo maschio-femmina, ottone	97			
G03243	Raccordo maschio-femmina, ottone	97			
G03244	Raccordo maschio-femmina, ottone	97			
G03245	Raccordo a riduzione, maschio-femmina, ottone	97			
G03246	Raccordo maschio-femmina, ottone	97			
G032465	Raccordo maschio-femmina, speciale per pilette, ottone	96			

Indice per articolo / Article index

Cod.	Descrizione	Pag.
G03403	Ghiera maschio-femmina, ottone	98
G03404	Ghiera maschio-femmina, ottone	98
G03410	Manicotto ridotto femmina-femmina, in ottone	94
G03411	Manicotto ridotto femmina-femmina, in ottone	94
G03412	Manicotto ridotto femmina-femmina, in ottone	94
G03413	Manicotto ridotto femmina-femmina, in ottone	94
G03420	Manicotto ridotto femmina-femmina, in ottone	94
G03421	Manicotto ridotto femmina-femmina, in ottone	94
G03422	Manicotto ridotto femmina-femmina, in ottone	94
G03423	Manicotto ridotto femmina-femmina, in ottone	94
G03501	Raccordo ottone tuttofiletto	101
G03502	Raccordo ottone tuttofiletto	101
G03503	Raccordo ottone tuttofiletto	101
G03504	Raccordo ottone tuttofiletto	101
G03511	Raccordo ottone tuttofiletto	101
G03512	Raccordo ottone tuttofiletto	101
G03513	Raccordo ottone tuttofiletto	101
G03514	Raccordo ottone tuttofiletto	101
G03521	Controdado con flangia, ottone	100
G03522	Controdado con flangia, ottone	100
G03523	Controdado con flangia, ottone	100
G03524	Controdado con flangia, ottone	100
G03525	Controdado con flangia, ottone	100
G03526	Controdado con flangia, ottone	100
G03531	Controdado con flangia, ottone	100
G03532	Controdado con flangia, ottone	100
G03533	Controdado con flangia, ottone	100
G03534	Controdado con flangia, ottone	100
G03535	Controdado con flangia, ottone	100
G03536	Controdado con flangia, ottone	100
G03600	Adattatore in ottone	154
G03602	Adattatore in ottone	154
G03604	Adattatore in ottone	154
G03608	Adattatore in ottone	154
G036081	Adattatori per flessibile per miscelatore, attacco femmina filetto M10 x 1, ottone cromato	138
G036091	Adattatori per flessibile per miscelatore, attacco femmina filetto M10 x 1, ottone cromato	138
G036111	Adattatori per flessibile per miscelatore, attacco femmina filetto M10 x 1, ottone cromato	138
G036121	Adattatori per flessibile per miscelatore, attacco femmina filetto M10 x 1, ottone cromato	138
G03700	Distanziale con dado girevole singolo, H45 mm, cromato	55
G03701	Distanziale con dado girevole singolo, H45 mm, cromato	55
I04096	Tubo a 45° senza flangia, in ottone, spessore tubo 0,4 mm	123
I04101	Tubo a 45° senza flangia, in ottone, spessore tubo 0,4 mm	123
I04103	Tubo a 45° senza flangia, in ottone, con rosone foro ovale, spessore tubo 0,4 mm	123
I04115	Tubo a squadra per scarico, ottone, con flangia, spessore tubo 0,4 mm	121
I04117	Tubo a squadra per scarico, ottone, con flangia, spessore tubo 0,4 mm	121

Cod.	Descrizione	Pag.
I04118	Tubo a 45° senza flangia, in ottone, con rosone foro ovale, spessore tubo 0,4 mm	123
I04149	Tubo diritto in ottone con flangia, spessore tubo 0,5 mm	122
I04150	Tubo diritto in ottone con flangia, spessore tubo 0,5 mm	122
I04151	Tubo diritto in ottone con flangia, spessore tubo 0,5 mm	122
I04153	Tubo diritto in ottone con flangia, spessore tubo 0,5 mm	122
I04154	Tubo diritto in ottone con flangia, spessore tubo 0,5 mm	122
I04155	Tubo diritto in ottone con flangia, spessore tubo 0,5 mm	122
I04157	Tubo diritto in ottone con flangia, spessore tubo 0,5 mm	122
I04158	Tubo diritto in ottone con flangia, spessore tubo 0,5 mm	122
I04159	Tubo diritto in ottone con flangia, spessore tubo 0,5 mm	122
I04162	Tubo diritto in ottone con flangia, spessore tubo 0,5 mm	122
I041672	Tubo diritto in ottone, spessore tubo 0,5 mm	122
I041674	Tubo diritto in ottone, spessore tubo 0,5 mm	122
I04181	Tubo diritto in ottone, spessore tubo 0,5 mm	122
I04182	Tubo diritto in ottone, spessore tubo 0,5 mm	122
I04183	Tubo diritto in ottone, spessore tubo 0,5 mm	122
I04186	Tubo diritto in ottone, spessore tubo 0,5 mm	122
I04187	Tubo diritto in ottone, spessore tubo 0,5 mm	122
I04188	Tubo diritto in ottone, spessore tubo 0,5 mm	122
I04191	Tubo diritto in ottone, spessore tubo 0,5 mm	122
I04192	Tubo diritto in ottone, spessore tubo 0,5 mm	122
I04193	Tubo diritto in ottone, spessore tubo 0,5 mm	122
I04201	Tubo diritto in ottone, spessore tubo 0,5 mm	122
I04206	Tubo diritto in ottone, spessore tubo 0,5 mm	122
I04208	Tubo diritto in ottone, spessore tubo 0,5 mm	122
I04210	Tubo diritto in ottone, spessore tubo 0,5 mm	122
I04213	Tubo diritto in ottone, spessore tubo 0,5 mm	122
I04218	Tubo a squadra per scarico, ottone, spessore tubo 0,5 mm	121
I04219	Tubo a squadra per scarico, ottone, spessore tubo 0,5 mm	121
I04222	Tubo a squadra per scarico, ottone, spessore tubo 0,5 mm	121
I04223	Tubo a squadra per scarico, ottone, spessore tubo 0,5 mm	121
I04225	Tubo a squadra per scarico, ottone, spessore tubo 0,5 mm	121
I04230	Tubo a squadra in ottone, per scarico a terra lavabo, spessore 0,5 mm	121
I04239	Tubo a squadra per scarico, ottone, spessore tubo 0,5 mm	121
I04244	Tubo eccentrico in ottone per scarico, spessore tubo 0,7 mm, spostamento 20 mm	123
I04245	Tubo eccentrico in ottone per scarico, spessore tubo 0,7 mm, spostamento 20 mm	123
I04246	Tubo eccentrico in ottone per scarico, spessore tubo 0,7 mm, spostamento 20 mm	123
I04251	Tubo per adduzione WC, rosone pesante	122
I04252	Tubo per adduzione WC, rosone pesante	122
I04253	Tubo per adduzione WC, rosone pesante	122
I04270	Giunzione ridotta, due o-ring	124
I04271	Giunzione ridotta, due o-ring	124
I04272	Giunzione ridotta, due o-ring	124
I04280	Giunzione per tubi in ottone, due o-ring	124
I04281	Giunzione per tubi in ottone, due o-ring	124
I04282	Giunzione per tubi in ottone, due o-ring	124
I04290	Prolunga per tubi in ottone, con o-ring	124
I04291	Prolunga per tubi in ottone, con o-ring	124

Indice per articolo / Article index

Cod.	Descrizione	Pag.	Cod.	Descrizione	Pag.
I04292	Prolunga per tubi in ottone, con o-ring	124	K064422	Flessibile doccia LINEA, cono ottone 1/2" + cono ottone girevole 1/2"	155
I04301	Tubo ottone per attacco scarico lavatrice, con flangia	125	K064520	Flessibile doccia LINEA HELIX, cono ottone 1/2" + cono ottone girevole 1/2"	155
I04322	Tubo ottone con aeratore	125	K064522	Flessibile doccia LINEA HELIX, cono ottone 1/2" + cono ottone girevole 1/2"	155
I04351	Tubo diritto in ottone con flangia, spessore tubo 0,5 mm	122	K064620	Flessibile doccia LINEA ARGENTO, cono ottone 1/2" + cono girevole 1/2"	155
I04351D	Tubo diritto in ottone con flangia, spessore tubo 0,5 mm	122	K064622	Flessibile doccia LINEA ARGENTO, cono ottone 1/2" + cono girevole 1/2"	155
I04352	Tubo diritto in ottone con flangia, spessore tubo 0,5 mm	122	K064720	Flessibile doccia INOX, cono ottone 1/2" + cono ottone girevole 1/2"	156
I04352D	Tubo diritto in ottone con flangia, spessore tubo 0,5 mm	122	K064722	Flessibile doccia INOX, cono ottone 1/2" + cono ottone girevole 1/2"	156
JAK0001	Raccordo antiritorno, maschio femmina, cromato.	56	K07032	Raccordo retrogruppo eccentrico 5 mm con arresto	75
JAK0002	Raccordo antiritorno, maschio femmina, cromato.	56	K07041	Raccordo retrogruppo con arresto	75
K003379	Coppia di distanziali per gruppi, in ottone, con calotta girevole e attacco da 3/8 cromato	55	K07042	Raccordo retrogruppo con arresto	75
K003478	Distanziale con dado girevole singolo, H45 mm, cromato	55	K07100	Rubinetto a fontana a pulsante, giallo	63
K011210	Eccentrico per radiatore, ottone nichelato	105	K07136	Morsetto gomma per scarico WC	125
K011220	Eccentrico per radiatore, ottone nichelato	105	K07137	Morsetto gomma per scarico WC	125
K011230	Eccentrico per radiatore, ottone nichelato	105	K07810	Prolunga ridotta, ottone	102
K011240	Eccentrico per radiatore, ottone nichelato	105	K07811	Prolunga ridotta, ottone	102
K011250	Eccentrico per radiatore, ottone nichelato	105	K07812	Prolunga ridotta, ottone	102
K011260	Eccentrico per radiatore, ottone nichelato	105	K07813	Prolunga ridotta, ottone	102
K011520	Eccentrico per radiatore, cromato lucido	105	K07814	Prolunga ridotta, ottone	102
K011530	Eccentrico per radiatore, cromato lucido	105	K07820	Prolunga ridotta, ottone	102
K013810	Eccentrico per radiatore, ottone nichelato	105	K07821	Prolunga ridotta, ottone	102
K013820	Eccentrico per radiatore, ottone nichelato	105	K07822	Prolunga ridotta, ottone	102
K013830	Eccentrico per radiatore, ottone nichelato	105	K07823	Prolunga ridotta, ottone	102
K013840	Eccentrico per radiatore, ottone nichelato	105	K07824	Prolunga ridotta, ottone	102
K013850	Eccentrico per radiatore, ottone nichelato	105	K07910	Barilotto filettato, ottone, maschio	101
K013860	Eccentrico per radiatore, ottone nichelato	105	K07911	Barilotto filettato, ottone, maschio	101
K03285	Tappo copriforo, Ø50 mm, completo di guarnizioni	150	K07912	Barilotto filettato, ottone, maschio	101
K03310	Eccentrico per gruppo parete, ottone	105	K07913	Barilotto filettato, ottone, maschio	101
K03320	Eccentrico per gruppo parete, ottone	105	K07920	Barilotto filettato, ottone, maschio	101
K04105	Tubetto in rame con raccordo maschio M10x1, OR	119	K07921	Barilotto filettato, ottone, maschio	101
K04106	Tubetto in rame con raccordo maschio M10x1, OR	119	K07922	Barilotto filettato, ottone, maschio	101
K04107	Tubetto in rame con raccordo maschio M10x1, OR	119	K07923	Barilotto filettato, ottone, maschio	101
K052202	Raccordo tre pezzi diritto maschio-femmina, sede conica con OR, ottone	104	K07930	Barilotto filettato, ottone, maschio	101
K052203	Raccordo tre pezzi diritto maschio-femmina, sede conica con OR, ottone	104	K07931	Barilotto filettato, ottone, maschio	101
K052204	Raccordo tre pezzi diritto maschio-femmina, sede conica con OR, ottone	104	K07932	Barilotto filettato, ottone, maschio	101
K052252	Raccordo tre pezzi diritto maschio-femmina, sede conica con OR, ottone	104	K07933	Barilotto filettato, ottone, maschio	101
K052253	Raccordo tre pezzi diritto maschio-femmina, sede conica con OR, ottone	104	K07934	Barilotto filettato, ottone, maschio	101
K052254	Raccordo tre pezzi diritto maschio-femmina, sede conica con OR, ottone	104	K07935	Barilotto filettato, ottone, maschio	101
K052352	Raccordo tre pezzi 90°, maschio-femmina, sede conica con OR, ottone	104	K07936	Barilotto filettato, ottone, maschio	101
K052353	Raccordo tre pezzi 90°, maschio-femmina, sede conica con OR, ottone	104	K07937	Barilotto filettato, ottone, maschio	101
K052354	Raccordo tre pezzi 90°, maschio-femmina, sede conica con OR, ottone	104	K07938	Barilotto filettato, ottone, maschio	101
K06122	Flessibile doccia OTTONE, cono ottone 1/2" + cono ottone girevole 1/2"	156	K07939	Barilotto filettato, ottone, maschio	101
K06124	Flessibile doccia OTTONE, cono ottone 1/2" + cono ottone girevole 1/2"	156	K07940	Barilotto filettato, ottone, maschio	101
K064420	Flessibile doccia LINEA, cono ottone 1/2" + cono ottone girevole 1/2"	155	K07941	Barilotto filettato, ottone, maschio	101
			K07950	Barilotto filettato, ottone, maschio	101
			K07954	Barilotto filettato, ottone, maschio	101
			K07955	Barilotto filettato, ottone, maschio	101
			K07970	Barilotto filettato, ottone, maschio	101
			K07971	Barilotto filettato, ottone, maschio	101
			K07972	Barilotto filettato, ottone, maschio	101
			K08011	Prolunga ottone pesante, con esagono. Normalizzata	103
			K08012	Prolunga ottone pesante, con esagono. Normalizzata	103
			K08013	Prolunga ottone pesante, con esagono. Normalizzata	103
			K08014	Prolunga ottone pesante, con esagono. Normalizzata	103
			K08015	Prolunga ottone pesante, con esagono. Normalizzata	103

Indice per articolo / Article index

Cod.	Descrizione	Pag.	Cod.	Descrizione	Pag.
K08016	Prolunga ottone pesante, con esagono. Normalizzata	103	K08060	Prolunga ottone pesante, con esagono. Normalizzata	103
K08017	Prolunga ottone pesante, con esagono. Normalizzata	103	K08061	Prolunga ottone pesante, con esagono. Normalizzata	103
K08018	Prolunga ottone pesante, con esagono. Normalizzata	103	K08063	Prolunga ottone pesante, con esagono. Normalizzata	103
K08019	Prolunga ottone pesante, con esagono. Normalizzata	103	K08101	Prolunga ottone pesante, con esagono. Normalizzata	103
K08020	Prolunga ottone pesante, con esagono. Normalizzata	103	K08102	Prolunga ottone pesante, con esagono. Normalizzata	103
K08021	Prolunga ottone pesante, con esagono. Normalizzata	103	K08103	Prolunga ottone pesante, con esagono. Normalizzata	103
K08022	Prolunga ottone pesante, con esagono. Normalizzata	103	K08104	Prolunga ottone pesante, con esagono. Normalizzata	103
K08023	Prolunga ottone pesante, con esagono. Normalizzata	103	K08105	Prolunga ottone pesante, con esagono. Normalizzata	103
K08024	Prolunga ottone pesante, con esagono. Normalizzata	103	K08106	Prolunga ottone pesante, con esagono. Normalizzata	103
K08025	Prolunga ottone pesante, con esagono. Normalizzata	103	K08107	Prolunga ottone pesante, con esagono. Normalizzata	103
K08026	Prolunga ottone pesante, con esagono. Normalizzata	103	K08108	Prolunga ottone pesante, con esagono. Normalizzata	103
K08027	Prolunga ottone pesante, con esagono. Normalizzata	103	K08109	Prolunga ottone pesante, con esagono. Normalizzata	103
K08028	Prolunga ottone pesante, con esagono. Normalizzata	103	K08110	Prolunga ottone pesante, con esagono. Normalizzata	103
K08029	Prolunga ottone pesante, con esagono. Normalizzata	103	K08131	Prolunga ottone pesante, con esagono. Normalizzata	103
K08030	Prolunga ottone pesante, con esagono. Normalizzata	103	K08132	Prolunga ottone pesante, con esagono. Normalizzata	103
K08031	Prolunga ottone pesante, con esagono. Normalizzata	103	K08133	Prolunga ottone pesante, con esagono. Normalizzata	103
K08033	Prolunga ottone pesante, con esagono. Normalizzata	103	K08134	Prolunga ottone pesante, con esagono. Normalizzata	103
K08041	Prolunga ottone pesante, con esagono. Normalizzata	103	K08135	Prolunga ottone pesante, con esagono. Normalizzata	103
K08042	Prolunga ottone pesante, con esagono. Normalizzata	103	K08136	Prolunga ottone pesante, con esagono. Normalizzata	103
K08043	Prolunga ottone pesante, con esagono. Normalizzata	103	K08137	Prolunga ottone pesante, con esagono. Normalizzata	103
K08044	Prolunga ottone pesante, con esagono. Normalizzata	103	K08138	Prolunga ottone pesante, con esagono. Normalizzata	103
K08045	Prolunga ottone pesante, con esagono. Normalizzata	103	K08139	Prolunga ottone pesante, con esagono. Normalizzata	103
K08046	Prolunga ottone pesante, con esagono. Normalizzata	103	K08441	Prolunga ottone 1/2" "ROMA", foro tondo diametro interno 14 mm	102
K08047	Prolunga ottone pesante, con esagono. Normalizzata	103	K08442	Prolunga ottone 1/2" "ROMA", foro tondo diametro interno 14 mm	102
K08048	Prolunga ottone pesante, con esagono. Normalizzata	103	K08443	Prolunga ottone 1/2" "ROMA", foro tondo diametro interno 14 mm	102
K08049	Prolunga ottone pesante, con esagono. Normalizzata	103	K08444	Prolunga ottone 1/2" "ROMA", foro tondo diametro interno 14 mm	102
K08050	Prolunga ottone pesante, con esagono. Normalizzata	103	K08445	Prolunga ottone 1/2" "ROMA", foro tondo diametro interno 14 mm	102
K08051	Prolunga ottone pesante, con esagono. Normalizzata	103	K08446	Prolunga ottone 1/2" "ROMA", foro tondo diametro interno 14 mm	102
K08052	Prolunga ottone pesante, con esagono. Normalizzata	103	K08447	Prolunga ottone 1/2" "ROMA", foro tondo diametro interno 14 mm	102
K08053	Prolunga ottone pesante, con esagono. Normalizzata	103	K08448	Prolunga ottone 1/2" "ROMA", foro tondo diametro interno 14 mm	102
K08054	Prolunga ottone pesante, con esagono. Normalizzata	103	K08449	Prolunga ottone 1/2" "ROMA", foro tondo diametro interno 14 mm	102
K08055	Prolunga ottone pesante, con esagono. Normalizzata	103	K08450	Prolunga ottone 1/2" "ROMA", foro tondo diametro interno 14 mm	102
K08056	Prolunga ottone pesante, con esagono. Normalizzata	103	K100041	Valvola antiaggomente, nylon, attacchi da 3/4" maschio-femmina	56
K08057	Prolunga ottone pesante, con esagono. Normalizzata	103	K10161	Aeratore linea	152
K08058	Prolunga ottone pesante, con esagono. Normalizzata	103	K10181	Aeratore linea	152
K08059	Prolunga ottone pesante, con esagono. Normalizzata	103	K10221	Aeratore standard	152
			K102216L	Aeratore portata limitata 6 l/min	153
			K10221AB	Aeratore antibatterico	154

Indice per articolo / Article index

Cod.	Descrizione	Pag.	Cod.	Descrizione	Pag.
K10221AC	Aeratore anticalcare siliconico	153	K35001	Scarico 1"1/4 lucidato, tappo ottone Ø64 copripiletta, dado ottone	148
K10241	Aeratore standard	152	K35002	Scarico 1"1/4 lucidato, tappo ottone Ø64 copripiletta, dado ottone	148
K102416L	Aeratore portata limitata 6 l/min	153	K35003	Scarico 1"1/4 lucidato, tappo ottone Ø64 copripiletta, dado ottone	148
K10241AB	Aeratore antibatterico	154	K36000	Scarico 1"1/4 lucidato, tappo ottone copripiletta, dado ottone	148
K10241AC	Aeratore anticalcare siliconico	153	K36001	Scarico 1"1/4 lucidato, tappo ottone copripiletta, dado ottone	148
K10281	Aeratore standard	152	K36002	Scarico 1"1/4 lucidato, tappo ottone copripiletta, dado ottone	148
K10281AC	Aeratore anticalcare siliconico	153	K36003	Scarico 1"1/4 lucidato, tappo ottone copripiletta, dado ottone	148
K10300	Aeratore incasso con chiave	154	K36051	Piletta griglia lavabo 1"1/4	148
K10301	Aeratore incasso con chiave	154	K37001	Piletta lavabo ottone a crociera	150
K10302	Aeratore incasso con chiave	154	K37010	Piletta Gattinara Ø80	151
K10303	Aeratore incasso con chiave	154	K38000	Snodo doppio per piletta con salterello	149
K12242	Raccordo MF 3/4 con antivuoto antiritorno	56	K38051	Tappo in gomma rivestimento in acciaio	151
K13161	Aeratore linea con snodo	153	K38053	Tappo in gomma	151
K13181	Aeratore linea con snodo	153	K70050	Set idroscopino tondo ottone flessibile antitorsione 120 cm, acciaio cromato	158
K13221	Aeratore con snodo	152	K70400	Supporto snodato abs tondo eco, 1 vite	158
K13241	Aeratore con snodo	152	K70405	Supporto snodato abs tondo lux, 1 vite	158
K14241	Cannuccia flessibile con aeratore, con doppio attacco M 24x1 e F 22x1	159	L02803	Presa acqua a 90° LINEA, rosone ottone	157
K15000	Deviatore 1/2" x 1/2" x 1/2"	159	L02803Q	Presa acqua QUADRO, rosone ottone, cromato	157
K30235	Sifone QUADRO a bottiglia	144	L02832	Presa acqua con supporto per doccia	157
K30401	Sifone SALVA SPAZIO	145	L105650	Rubinetto sottolavabo, vitone quarto di giro, maniglia zama GOCCIA, rosone ottone, cromato	11
K30413	Curva 90° in ottone per tubo Ø32 tenuta o-ring, dado girevole 1"1/4	145	L143481	Rubinetto sottolavabo LINEA con filtro, vitone, maniglia ottone, rosone ottone, dado cilindrico, cromato. Vitone brevettato n°22566 B/85	10
K30414	Curva 90° in ottone per tubo Ø32 tenuta o-ring	145	L202560	Carter cromato con guarnizione	11
K31032	Sifone LINEA ITA 01	144	L441650	Rubinetto sottolavabo LINEA, vitone, maniglia zama, con rosone ottone, con carter, cromato	11
K31032T	Sifone LINEA ITA 02	144	L446450	Rubinetto sottolavabo LINEA, vitone, maniglia zama GOCCIA, rosone ottone, cromato	10
K31726	Sifone a bottiglia, tubi 250 e 75 mm, rosone	142	L447604	Rubinetto sottolavabo LINEA QUADRO, vitone, maniglia ottone QUADRO, rosone ottone, dado cilindrico, cromato	12
K31732	Sifone a bottiglia, tubi 250 e 75 mm, rosone	142	L447650	Rubinetto sottolavabo LINEA, vitone, maniglia zama GOCCIA, rosone ottone, dado cilindrico, cromato	10
K32226	Sifone a "S", tubi 250 e 75 mm, ispezione laterale, rosone	142	L447681Q	Rubinetto sottolavabo QUADRO, vitone, maniglia ottone QUADRO, rosone ottone, dado cilindrico, cromato	12
K32232	Sifone a "S", tubi 250 e 75 mm, ispezione laterale, rosone	142	L448604	Rubinetto sottolavabo LINEA QUADRO, vitone, maniglia ottone QUADRO, rosone ottone, cromato	12
K32426	Sifone ad "U", tubi 250 e 75 mm, ispezione posteriore, rosone	142	L448650	Rubinetto sottolavabo LINEA, vitone, maniglia zama GOCCIA, rosone ottone, cromato	10
K32432	Sifone ad "U", tubi 250 e 75 mm, ispezione posteriore, rosone	142	L906773	Rubinetto lavatrice a sfera LINEA, maniglia ottone, rosone ottone, cromato	52
K32832	Sifone bidet con gomito ribassato, con foro ispezione laterale	143	M04128	Tubo pieghevole in rame per scarico	120
K34001	Piletta lavabo "SCATTO", lucidata, cromata tappo Ø63, H55 mm, con troppo-pieno	147	M04129	Tubo pieghevole in rame per scarico	120
K3400111	Piletta lavabo "SCATTO", lucidata, cromata tappo Ø63, H55 mm, con troppo-pieno	147	M04131	Tubo pieghevole in rame per scarico	120
K3400112	Piletta lavabo "SCATTO", lucidata, cromata tappo Ø63, H55 mm, con troppo-pieno	147	M04133	Tubo pieghevole in rame per scarico	120
K340015	Piletta a scatto RAPID, con troppo pieno, UNIVERSALE, ottone lucido, cromata, tappo Ø 63	146	M04134	Tubo pieghevole in rame per scarico	120
K34002	Piletta lavabo "SCATTO", lucidata, cromata tappo Ø63, H55 mm, con troppo-pieno	147	M04136	Tubo pieghevole in rame per scarico	120
K34003	Intercalare per troppo pieno, ABS cromato	143	M04161	Tubo pieghevole in rame per scarico	120
K34004	Distanziale per lavabo H31 mm, ABS	147	M04162	Tubo pieghevole in rame per scarico	120
K34005	Solo tappo ottone Ø 64	149	M04164	Tubo pieghevole in rame per scarico	120
K340055	Solo tappo ottone	149	M04263	Tubo pieghevole di rame	120
K340056	Solo tappo ottone	149	M04264	Tubo pieghevole di rame	120
K34006	Piletta lavabo "SCATTO", lucidata, cromata tappo Ø63, H55 mm, con troppo-pieno	147			
K34017	Piletta a scarico libero, con troppo pieno, UNIVERSALE, ottone lucido, cromata, tappo Ø63	146			
K34020	Piletta a scatto EVO, con troppo pieno, UNIVERSALE, ottone lucido, cromata, tappo Ø32	146			
K34050	Prolunga per piletta a scatto maschio-femmina, H90 mm	147			
K34300	Piletta griglia ottone Ø80	150			
K34301	Piletta griglia ottone Ø80	150			
K35000	Scarico 1"1/4 lucidato, tappo ottone Ø64 copripiletta, dado ottone	148			

Indice per articolo / Article index

Cod.	Descrizione	Pag.	Cod.	Descrizione	Pag.
M04265	Tubo pieghevole di rame	120	M361313	Tubo pieghevole in rame, flangia stampata, cromato	117
M04266	Tubo pieghevole di rame	120	M361604	Tubo pieghevole in rame, flangia stampata, cromato	117
M04268	Tubo di rame in rotolo	119	M361605	Tubo pieghevole in rame, flangia stampata, cromato	117
M04269	Tubo di rame in rotolo	119	M361606	Tubo pieghevole in rame, flangia stampata, cromato	117
M04270	Tubo di rame in rotolo	119	M361608	Tubo pieghevole in rame, flangia stampata, cromato	117
M04271	Tubo pieghevole di rame	120	M361613	Tubo pieghevole in rame, flangia stampata, cromato	117
M04272	Tubo pieghevole di rame	120	M362604	Tubo pieghevole in rame, flangia stampata, cromato	117
M04274	Tubo pieghevole di rame	120	M362606	Tubo pieghevole in rame, flangia stampata, cromato	117
M04278	Tubo di rame in rotolo	119	M362608	Tubo pieghevole in rame, flangia stampata, cromato	117
M04282	Tubo pieghevole di rame	120	M365304	Tubo pieghevole in rame, flangia tornita e saldata, cromato	116
M1214160	Estensione tubo rame per radiatori, uscita maschio 1/2", lucidato	119	M365306	Tubo pieghevole in rame, flangia tornita e saldata, cromato	116
M12304	Prolunga in tubo di rame, dado conico basso	118	M365308	Tubo pieghevole in rame, flangia tornita e saldata, cromato	116
M12306	Prolunga in tubo di rame, dado conico basso	118	M365313	Tubo pieghevole in rame, flangia tornita e saldata, cromato	116
M12308	Prolunga in tubo di rame, dado conico basso	118	M365604	Tubo pieghevole in rame, flangia tornita e saldata, cromato	116
M272704	Tubetto pieghevole in rame, due flange stampate da 1/2" con dadi, cromato	117	M365606	Tubo pieghevole in rame, flangia tornita e saldata, cromato	116
M272706	Tubetto pieghevole in rame, due flange stampate da 1/2" con dadi, cromato	117	M365608	Tubo pieghevole in rame, flangia tornita e saldata, cromato	116
M272708	Tubetto pieghevole in rame, due flange stampate da 1/2" con dadi, cromato	117	M365609	Tubo pieghevole in rame, flangia tornita e saldata, cromato	116
M272709	Tubetto pieghevole in rame, due flange stampate da 1/2" con dadi, cromato	117	M365613	Tubo pieghevole in rame, flangia tornita e saldata, cromato	116
M272711	Tubetto pieghevole in rame, due flange stampate da 1/2" con dadi, cromato	117	M371404	Tubo pieghevole in rame, due flange stampate da 1/2" e 3/8", cromato	117
M272713	Tubetto pieghevole in rame, due flange stampate da 1/2" con dadi, cromato	117	M371406	Tubo pieghevole in rame, due flange stampate da 1/2" e 3/8", cromato	117
M301003	Squadra di raccordo in tubo rame	118	M371408	Tubo pieghevole in rame, due flange stampate da 1/2" e 3/8", cromato	117
M302006	Squadra di raccordo in tubo rame	118	M371409	Tubo pieghevole in rame, due flange stampate da 1/2" e 3/8", cromato	117
M302008	Squadra di raccordo in tubo rame	118	M371410	Tubo pieghevole in rame, due flange stampate da 1/2" e 3/8", cromato	117
M304010	Squadra di raccordo in tubo rame	118	M371411	Tubo pieghevole in rame, due flange stampate da 1/2" e 3/8", cromato	117
M304013	Squadra di raccordo in tubo rame	118	M371413	Tubo pieghevole in rame, due flange stampate da 1/2" e 3/8", cromato	117
M312606C	Squadra di raccordo in tubo rame, niples giallo 1/2", rosone ottone, dado 1/2", confezionati a coppie	118	M381304	Tubo pieghevole in rame, flangia tornita e saldata, dado, attacchi MF, niples H35, cromato	116
M312608C	Squadra di raccordo in tubo rame, niples giallo 1/2", rosone ottone, dado 1/2", confezionati a coppie	118	M381306	Tubo pieghevole in rame, flangia tornita e saldata, dado, attacchi MF, niples H35, cromato	116
M314610C	Squadra di raccordo in tubo rame, niples giallo 1/2", rosone ottone, dado 1/2", confezionati a coppie	118	M381308	Tubo pieghevole in rame, flangia tornita e saldata, dado, attacchi MF, niples H35, cromato	116
M314613C	Squadra di raccordo in tubo rame, niples giallo 1/2", rosone ottone, dado 1/2", confezionati a coppie	118	M381313	Tubo pieghevole in rame, flangia tornita e saldata, dado, attacchi MF, niples H35, cromato	116
M314617C	Squadra di raccordo in tubo rame, niples giallo 1/2", rosone ottone, dado 1/2", confezionati a coppie	118	M381504	Tubo pieghevole in rame, flangia tornita e saldata, dado, attacchi MF, niples H35, cromato	116
M314618C	Squadra di raccordo in tubo rame, niples giallo 1/2", rosone ottone, dado 1/2", confezionati a coppie	118	M381506	Tubo pieghevole in rame, flangia tornita e saldata, dado, attacchi MF, niples H35, cromato	116
M351002	Tubo pieghevole di rame	120	M381508	Tubo pieghevole in rame, flangia tornita e saldata, dado, attacchi MF, niples H35, cromato	116
M351004	Tubo pieghevole di rame	120			
M351006	Tubo pieghevole di rame	120			
M351008	Tubo pieghevole di rame	120			
M351009	Tubo pieghevole di rame	120			
M351011	Tubo pieghevole di rame	120			
M352018	Tubo pieghevole di rame	120			
M360621	Tubo pieghevole in rame, flangia stampata, cromato	117			
M360623	Tubo pieghevole in rame, flangia stampata, cromato	117			
M361304	Tubo pieghevole in rame, flangia stampata, cromato	117			
M361306	Tubo pieghevole in rame, flangia stampata, cromato	117			
M361308	Tubo pieghevole in rame, flangia stampata, cromato	117			



Indice per articolo / Article index

Cod.	Descrizione	Pag.
R12804	Ranella piatta in ottone	111
R12805	Ranella piatta in ottone	111
R12806	Ranella piatta in ottone	111
R12810	Ranella conica fresata in ottone	111
R12811	Ranella conica fresata in ottone	111
R12812	Ranella conica fresata in ottone	111
R12813	Ranella conica fresata in ottone	111
R12814	Ranella conica fresata in ottone	111
R12815	Ranella conica fresata in ottone	111
R15101	Guarnizione in gomma	111
R15102	Guarnizione in gomma	111
R15103	Guarnizione in gomma	111
R15104	Guarnizione in gomma	111
R15105	Guarnizione in gomma	111
R15106	Guarnizione in gomma	111
R15108	Guarnizione in gomma	111
R15110	Guarnizione conica in gomma	112
R15112	Guarnizione conica in gomma	112
R15113	Guarnizione conica in gomma	112
R15114	Guarnizione conica in gomma	112
R152015	Bussola speciale completa di ranella fresata, guarnizione in gomma e bussola in nylon	112
R15301	Guarnizione in fibra	112
R15302	Guarnizione in fibra	112
R15303	Guarnizione in fibra	112
R15304	Guarnizione in fibra	112
R15307	Guarnizione in fibra	112
R15310	Guarnizione in fibra	112
R15420	Vitone giardino con volantino di ricambio completo di vite	65
R15425	Vitone giardino con volantino di ricambio completo di vite	65
R15430	Vitone giardino con chiave levabile completo di vite	65
R15435	Vitone giardino con chiave levabile completo di vite	65
R181075	Maniglia ABS, broccia 8x20	58
R181085	Maniglia ABS, broccia 8x20	58
R1810855	Maniglia ABS, broccia 8x20	58
R181086	Maniglia triangolare, broccia 8x20	58
R50101	Rosone normale inox	126
R50102	Rosone normale inox	126
R50103	Rosone normale ottone	126
R50104	Rosone normale ottone	126
R50104/70	Rosone normale ottone	126
R50105	Rosone normale ottone	126
R50106	Rosone normale ottone	126
R50108	Rosone apribile, ottone	127
R50109	Rosone apribile, ottone	127
R50110	Rosone apribile, ottone	127
R50111	Rosone apribile, ottone	127
R50112	Rosone apribile, ottone	127
R50116	Rosone inox per sottolavabo	129
R50117	Rosone inox per sottolavabo	129
R50118	Rosone inox per sottolavabo	129
R50119	Rosone ottone per sottolavabo	129
R50120	Rosone ottone per sottolavabo	129
R50121	Rosone ottone per sottolavabo	129
R50125	Rosone filettato, ottone	127
R50128	Rosone scorrevole ottone con ghiera	126
R50129	Rosone scorrevole ottone con ghiera	126
R50131	Rosone scorrevole inox con ghiera	127
R50132	Rosone scorrevole inox con ghiera	127
R501325	Rosone scorrevole inox con ghiera	127
R50133	Rosone inox con foro esagonale	128

Cod.	Descrizione	Pag.
R50134	Rosone inox con foro esagonale	128
R50145	Rosone con foro ovale	130
R50146	Rosone inox con foro ovale	130
R50149	Rosone conico, per tubo adduzione WC	130
R50150	Rosone conico, per tubo adduzione WC	130
R50151	Rosone conico, per tubo adduzione WC	130
R50154	Rosone conico, per tubo adduzione WC	131
R50155	Rosone conico, per tubo adduzione WC	131
R50156	Rosone conico, per tubo adduzione WC	131
R50158	Rosone conico, per tubo adduzione WC	131
R50164	Rosone a scatola	131
R50165	Rosone a scatola	131
R50166	Rosone a scatola	131
R50167	Rosone a scatola	131
R50169	Rosone gigante in ottone	129
R50170	Rosone gigante in ottone	129
R50171	Rosone gigante in ottone	129
R50172	Rosone con foro ovale	130
R50173	Rosone con foro ovale	130
R50181	Rosone apribile, ottone	127
R50182	Rosone apribile, ottone	127
R50183	Rosone apribile, ottone	127
R50184	Rosone apribile, ottone	127
R50192	Rosone ottone Ø45 mm per tubo Ø14 mm	131
R50204	Rosone scorrevole ottone LINEA cromato	128
R50214	Rosone scorrevole ottone LINEA QUADRO cromato	128
R7800	Chiave levabile per rubinetti giardino	65
R7805	Chiave levabile per rubinetti giardino	65
R7810	Chiave levabile per rubinetti giardino	65
R7815	Chiave levabile per rubinetti giardino	65
SL028.043	Vitone con broccia 8x20	57
SL028.0435	Vitone antiritorno, con broccia 8x20	57
SL028.0437	Vitone con broccia 8x20	57
SL028.049	Vitone antiritorno, con broccia 8x20	57
SL033.015	Maniglia triangolare, broccia 8x20	58
SL053.01	Filtro acciaio inox	29
SL054.20	Segnalatori per aggancio maniglia	58
SL054.205	Segnalatori per aggancio maniglia	58
SL067.000	Tappo rubinetto filtro con guarnizione	29

Condizioni generali di vendita

DA VALERE PER OGNI CONTRATTO DI COMPRAVENDITA INTERCORRENTE TRA VENDITORE (come infra definito) ed ACQUIRENTE (come infra definito)

I termini e le locuzioni definiti nelle presenti Condizioni generali di vendita hanno, quando indicati con la lettera iniziale maiuscola, il significato ad essi convenzionalmente attribuito o richiamato nel presente articolo:

Contratto di compravendita: accordo tra venditore ed acquirente per il trasferimento a favore del secondo della proprietà di una cosa dietro pagamento del prezzo.

Condizioni generali di vendita: I termini e le condizioni indicati nel presente atto da valere quale parte integrante e sostanziale di ciascun contratto di compravendita concluso tra venditore ed acquirente per la compravendita dei prodotti.

Il venditore si riserva il diritto di modificare, integrare o variare le condizioni generali di vendita inviando tali variazioni all'acquirente. Qualora le modifiche, integrazioni o variazioni delle CGV non siano accettate dall'acquirente per iscritto entro 15 giorni dalla data di comunicazione, il venditore potrà interrompere il rapporto contrattuale con l'acquirente senza che questi possa lamentare danni e/o pretendere indennizzi.

1. CONCLUSIONE DEL CONTRATTO

Il contratto di compravendita si perfezionerà nel momento in cui:

a) l'acquirente anche per fatti concludenti quali, ma non solo, la trasmissione al venditore di una lettera di credito o il pagamento in tutto o in parte del prezzo della fornitura, accetti, senza alcuna modifica, la proposta contrattuale, con qualunque mezzo formulata dal Venditore. Ad ogni singolo contratto di compravendita come sopra perfezionato, si applicheranno, ancorchè non riportate ed espressamente accettate, le CGV di cui al presente atto, ove non espressamente derogate per iscritto. Pertanto, eventuali condizioni contrattuali difformi da quelle del presente atto, ancorchè riportate per iscritto su documenti (moduli, formulari ecc) provenienti dall'acquirente, saranno prive di valore ove non espressamente accettate per iscritto dal venditore. In nessun caso, il comportamento del venditore potrà essere assunto a dimostrazione dell'accettazione di condizioni contrattuali diverse di cui alle presenti CGV. Allo stesso modo non potranno essere adottati contro il venditore comportamenti/ azioni degli agenti del venditore essendo questi privi di potere di rappresentanza.

b) La presente scrittura costituisce proposta irrevocabile d'acquisto con efficacia vincolante per il proponente per il periodo indicato in epigrafe, o in difetto, per tre mesi dalla sottoscrizione.

c) Il contratto di compravendita di cui alla presente proposta si intenderà perfezionato con l'accettazione di VA Albertoni Spa in qualunque modo manifestata, anche mediante l'inizio dell'esecuzione ai sensi dell'art. 1327 c.c.

d) L'obbligazione posta a carico di VA Albertoni Spa con il contratto di cui alla presente proposta si esaurisce nella consegna del materiale.

2) RISERVA DI ACCETTAZIONE E FACOLTÀ DI DISDETTA

Qualora la presente commissione sia raccolta da rappresentanti o concessionari, la Casa si riserva il diritto di accettare in tutto o in parte le condizioni pattuite.

3) DATI INFORMATIVI

Le indicazioni - sia di forma, misura e peso, sia di qualità e quantità - segnate nelle illustrazioni, nei cataloghi e nei preventivi si intendono sempre approssimative e non vincolanti, pertanto è esclusa ogni responsabilità della venditrice in caso di variazione dei dati stessi.

4) OGGETTO DEL CONTRATTO

Ogni contratto di compravendita riguarderà unicamente i prodotti (tipologia, quantità) espressamente indicati nei documenti contrattuali. Il Venditore dichiara che i prodotti sono conformi alle norme italiane e comunitarie di settore ad essi applicabili, ma specifica che le rappresentazioni e/o immagini degli stessi riportate in cataloghi, brochure, siti internet e/o documenti similari hanno valore meramente illustrativo e non vincolante. L'acquirente anteriormente alla conclusione di ogni singolo contratto di compravendita dovrà verificare che i prodotti siano idonei allo scopo e/o all'uso specifico per il quale intende acquistarli. L'acquirente dovrà altresì verificare, esonerando il venditore da ogni responsabilità al riguardo, che i prodotti compravenduti siano conformi alla normativa dello Stato in cui intende importarli. L'acquirente salva la garanzia per vizi, manleverà il venditore da eventuali pretese dei propri aventi causa per asserita inidoneità/non conformità dei prodotti ai loro bisogni.

5) PREZZO

a) Il prezzo, precisato nella commissione, è inteso - salvo diverso accordo - per consegna del materiale franco sede della Casa/Filiale.

b) L'I.V.A., eventuali altre tasse ed imposte anche per tributi locali, la registrazione del contratto in caso d'uso sono a totale carico dell'acquirente in aggiunta al detto prezzo. Le somme necessarie per far fronte a eventuali oneri e spese sono a carico dell'acquirente (ad es, imballaggio aggiuntivo).

6) RISERVATO DOMINIO

La vendita viene fatta con riserva di proprietà di cui agli articoli 1523 c.c. e seguenti sicché le cose vendute passeranno in proprietà dell'acquirente soltanto col pagamento dell'ultima rata. L'acquirente assume tutti i rischi e pericoli anche per i casi fortuiti o di forza maggiore, obbligandosi a denunciare immediatamente alla venditrice le eventuali azioni conservative o esecutive promosse da terzi nonché ogni rimozione dei materiali VA Albertoni Spa in altre località. Il mancato pagamento anche di una sola rata che superi l'ottava parte del prezzo, determina - a scelta della Casa - o la risoluzione del contratto o la decadenza dell'acquirente dal beneficio del termine in relazione alle rate successive ed inoltre determina l'annullamento dello sconto valuta eventualmente praticato all'atto dell'ordine, essendo sempre condizionato al puntuale ed effettivo pagamento. Se ha luogo la risoluzione del contratto per inadempimento dell'acquirente le rate di prezzo pagate restano acquisite dalla Casa a titolo di indennità a rifusione delle spese incontrate nella vendita e dei danni subiti salvo il diritto di ripetere i danni maggiori.

In caso di esercizio della riserva di proprietà da parte di VA Albertoni Spa l'equo compenso ed il risarcimento del danno dovuto alla Casa dall'acquirente vengono convenzionalmente pattuiti in misura pari al 25% del prezzo contrattuale, per quanto concerne il risarcimento del danno e in misura pari al 3,5% del prezzo contrattuale per ciascun mese di utilizzo del materiale da parte dell'acquirente, sino alla risoluzione del contratto, con il limite del 50% del prezzo contrattuale per quanto concerne l'equo compenso. Le rate già pagate dall'acquirente verranno trattenute dalla Casa in conto equo compenso e risarcimento del danno, salva la restituzione della parte eccedente.

Stante la riserva di proprietà, l'acquirente non potrà vendere il materiale prima dell'integrale pagamento del prezzo. In caso di vendita illegittima, impregiudicata ogni azione dinanzi alla competente autorità civile e penale, il cliente sarà tenuto all'integrale pagamento del prezzo e ad una penale pari al 15% del valore della cosa venduta.

7) PAGAMENTO

a) I pagamenti debbono essere praticati, per contanti, in valuta legale alla sede della Casa, autorizzata questa ultima all'emissione di tratte alle scadenze di pagamento precisate nella presente commissione ed in mancanza di esse a vista - con aggravio delle spese d'incasso bancarie.

b) Le cambiali eventualmente rilasciate devono intendersi a garanzia e non a pagamento. L'eventuale accettazione da parte del venditore di cambiali, pagherò, cessioni o assegni bancari si intende sempre convenuta salvo buon fine e/o pro solvendo e senza novazione del debito. In nessun caso, l'acquirente sarà liberato per pagamenti svolti nelle mani di agenti di vendita del venditore.

c) L'emissione delle ricevute bancarie è senza addebito di spese; tuttavia dopo il primo insoluto non giustificato tali spese saranno addebitate per le presentazioni successive con un costo di Euro 3,00 per ogni singola presentazione.

d) In ogni caso, in caso di mancato pagamento anche parziale delle scadenze pattuite, per il solo effetto del mancato pagamento e quindi senza necessità di messa in mora: * la Casa potrà interrompere immediatamente ogni ulteriore fornitura, anche se relativa ad altri contratti;

* verrà riconosciuto il risarcimento dei costi per il recupero del credito e decorreranno automaticamente gli interessi moratori pari al tasso ufficiale europeo incrementato di 7 punti a favore della casa, ovvero di 8 punti in caso di transazioni concluse a partire dal 1° gennaio 2013, così come previsto dal D.Lgs n.231/2002 e successive modifiche;

* l'acquirente dovrà ritenersi decaduto dal beneficio del termine, con conseguente diritto per la Casa di richiedere immediatamente il pagamento dell'intero credito nei suoi confronti, per tutte le forniture eseguite e non ancora saldate.

e) In caso di mancato pagamento dopo il primo sollecito, la suddetta società, avvalendosi della normativa di cui sopra, provvederà a comunicare e successivamente ad addebitare un onere quale corrispettivo delle spese sostenute per la gestione della pratica di recupero oltre gli interessi moratori.

f) Il venditore potrà sospendere le consegne dei prodotti anche nell'eventualità in cui l'acquirente, ancorchè non ancora moroso nei suoi confronti, abbia subito, in diminuzione, un mutamento delle condizioni patrimoniali e non abbia prestato le garanzie promesse. Salva la sospensione dell'esecuzione del singolo contratto di compravendita di cui sopra, il venditore potrà recedere da ciascun singolo contratto ove l'acquirente entro 15 giorni dalla richiesta non provveda a fornire idonea garanzia circa la propria solvibilità.

8) CLAUSOLA SOLVE ET REPETE

L'Acquirente non potrà sospendere o ritardare il pagamento dei prodotti per nessun motivo, ivi compresi pretesi vizi o difetti degli stessi, salva naturalmente la facoltà di ripetere quando possa dimostrare di avere indebitamente pagato.

Condizioni generali di vendita

9) CONSEGNA

- a) La consegna si intende praticata ad ogni effetto presso la sede della Casa, anche quando - per espressa pattuizione - il prezzo comprenda le spese di trasporto, precisato che la scelta dello spedizioniere o del vettore è rimessa alla discrezione della Casa, ancorché sussista una diversa indicazione da parte dell'acquirente. Le eventuali contestazioni devono essere inoltrate dal cliente sia al vettore e sia alla VA Albertoni Spa appena conosciute e comunque entro e non oltre 8 (otto) giorni dal ricevimento dalla merce.
- b) I termini di consegna fanno sempre riferimento a giorni lavorativi e devono intendersi valevoli solo in condizioni normali di lavoro e approvvigionamento, gli stessi - salvo diverso impegno scritto, assunto unicamente dalla Direzione della Casa - non sono comunque tassativi e sono meramente indicativi e la proroga di essi non determinerà a favore dell'acquirente alcun diritto a richiedere indennizzi, ogni eccezione rimossa.

10) GARANZIA

- a) La Casa garantisce la buona qualità dei materiali e la buona esecuzione nella loro costruzione.
- b) Salvo diversa pattuizione da concordarsi con la Direzione della Casa e nella sola forma scritta, la durata della garanzia è quella prevista dal Codice Civile, art. 1495 del cc.
- c) La VA Albertoni Spa risponde, nei confronti dei consumatori così come definiti dall'art. 3 del Codice del Consumo - D.Lgs. n. 206/2005, a far data dalla consegna, dei danni che derivano da difetti dei propri materiali, entro i limiti, termini e condizioni di cui agli artt. Da 114 a 127 del medesimo decreto.
- d) L'acquirente si impegna a controllare la merce all'atto della consegna e decade dal diritto alla garanzia nei seguenti casi:
- se non osserva, anche per una sola, le condizioni di pagamento;
 - se i materiali non sono stati montati e posti in opera secondo le istruzioni della Casa e, comunque, in modo errato o non conforme alle buone regole costruttive;
 - se i materiali forniti vengono usati in modo errato o diverso da quello indicato nel catalogo VA Albertoni Spa relativo al prodotto venduto o, comunque, fuori dei valori minimi e massimi nello stesso precisati;
- e) Vizi e difetti devono essere denunciati nei termini di legge e solo per iscritto alla sede della Casa.
- f) La Casa si obbliga, unicamente, a riparare o, a Sua scelta, a sostituire gratuitamente quei componenti forniti che, entro il periodo di garanzia, presentassero vizi di materiale o suoi difetti di costruzione tali da rendere gli stessi inidonei all'uso a cui sono destinati, preclusa comunque all'acquirente la domanda redibitoria sia essa di risoluzione o di riduzione di prezzo della fornitura.
- g) I materiali o le loro parti da riparare o da sostituire dovranno essere consegnati in porto franco a cura e spese dell'acquirente presso la sede indicata dalla Casa, quelli dati a nuovo o riparati saranno consegnati franchi stessa sede. I materiali che fossero oggetto di sostituzione rimarranno di proprietà della Casa.

11) FORZA MAGGIORE

Ciascuna parte potrà sospendere l'esecuzione dei suoi obblighi derivanti da ciascun specifico contratto di compravendita quando tale esecuzione sia resa impossibile o oggettivamente troppo onerosa da una circostanza imprevedibile indipendente dalla sua volontà. In tali eventualità, il termine per l'esecuzione della fornitura verrà prorogato per un periodo uguale alla durata dell'evento di forza maggiore. Qualora l'impedimento perduri per un termine superiore a 90 giorni ciascuna parte potrà recedere dal contratto dandone comunicazione scritta all'altra. A puro fine esemplificativo, le parti riconoscono che per il venditore costituirà forza maggiore il verificarsi di situazioni quali guerre, terremoti, emergenze epidemiologiche, scioperi difficoltà insorte con la forza lavoro, atti pubblica autorità (DPCM) o altra situazione alla quale il venditore non potrà porre rimedio tramite l'ordinaria diligenza.

12) MARCHI E SEGNI DISTINTIVI DEL VENDITORE

L'acquirente è autorizzato ad usare marchi, nomi e altri segni distintivi del venditore al solo fine di identificare e pubblicizzare i prodotti di quest'ultimo. Tale diritto cesserà trascorsi 90 giorni dalla data di esecuzione dell'ultimo contratto di compravendita intercorso tra le parti. L'acquirente informerà il venditore di qualsiasi violazione dei marchi, nomi e segni distintivi del venditore di cui venga a conoscenza.

13) TUTELA DELLA PRIVACY - D. Lgs. 196/2003

I dati personali acquisiti, direttamente e/o tramite terzi, dalla ditta VA Albertoni Spa titolare del trattamento, vengono trattate in forma cartacea, informatica, telematica per esigenze contrattuali e di Legge, nonché per consentire una efficace gestione dei rapporti commerciali, anche futuri. Il mancato conferimento dei dati, ove non obbligatorio, sarà valutato di volta in volta dall'azienda titolare del trattamento e determinerà conseguenze commisurate all'importanza dei dati richiesti per la gestione del rapporto commerciale. I dati potranno essere trattati esclusivamente per le finalità sopra indicate e potranno essere comunicati a: rete agenti, società di factoring, istituti di credito, società di recupero crediti, società di assicurazione del credito, società di informazioni commerciali, professionisti e consulenti, soggetti ai quali la facoltà di accedere ai dati personali sia riconosciuta dalle disposizioni di Legge regolamentari o comunitarie. L'interessato potrà esercitare tutti i diritti di cui all'articolo 7 del D. Lgs. 196/2003 (tra cui i diritti di accesso, rettifica, aggiornamento, di opposizione al trattamento e di cancellazione).

14) FORO DI COMPETENZA ESCLUSIVO

Tutte le controversie giudiziali, comunque insorgenti tra le parti in sede di interpretazione ed esecuzione della presente scrittura, sono devolute dalle parti contraenti alla competenza esclusiva del Foro di Novara. Il contratto di compravendita è normato dalla legge italiana.

General sale terms

EACH ORDER SENT TO US MEANS ACCEPTANCE OF OUR GENERAL SALE TERMS LISTED BELOW. THE CUSTOMER'S GENERAL TERMS AND CONDITIONS OF BUSINESS ARE NOT RECOGNIZED

- Orders taken by our representatives are not valid until after our acceptance or confirmation. The delivery terms indicated in the order confirmation are indicative and do not constitute any commitment for our part; if we cannot meet the agreed delivery date for reasons (stoppages, strike, lock-out, power supply problems, delays in the supply of essential raw and materials etc.) we shall inform the Customer. No compensation can be claimed.
- Our marketing material like brochures, pictures, drawings is indicative only; we reserve the right to make technical or production changes when the goods are not thereby significantly altered.
- Our goods travel at the risk and peril of the recipient, even in the case of carriage paid. The risk of accidental loss and of accidental deterioration of the goods shall pass to the Customer as soon as the goods are handed over for transportation. In case of damages, report reserves to the carrier and appeal them for damages claim.
- Goods have to be considered of our own property until the whole amount of the invoice has been settled.
- We can accept customers' complaints only within 8 days from reception of the goods.
- According to the rules of the EEC n° 85/374 dated 20/07/85 regarding "Responsibility of the producer", we will only be responsible for damages whose origin could exclusively be ascribed to defects in our manufacture. Damages resulting from installation defects due to inexperience or non-compliance with the use instructions are excluded. The responsibility consists only in the free replacement of the defective item. Refunding of damages to the end user is subject to the unobjectionable survey of our Insurance Company.
- Our items are designed and manufactured for hygienic-sanitary use, therefore within the temperature and pressure indicated by the UNI EN 200 standard.
- For any dispute the competent court is Novara.



seguici su:

www.va-albertoni.it 

Via Santa Rita, 34
28024 Gozzano (NO) Italy

Tel. +39 0322 91 48 00
Fax +39 0322 91 48 50

info@va-albertoni.it

